

OWNER'S MANUAL

MINI COOPER
MINI COOPER S





CONGRATULATIONS ON YOUR NEW MINI

This Owner's Manual should be considered a permanent part of this vehicle. It should stay with the vehicle when sold to provide the next owner with important operating, safety and maintenance information.

This manual is supplemented by a Service and Warranty Information Booklet for US models or a Warranty and Service Guide Booklet for Canadian models.

We recommend that you read this publication thoroughly.

Your MINI is covered by the following warranties:

- New Vehicle Limited Warranty
- Limited Rust Perforation Warranty
- Federal Emissions System Defect Warranty
- Federal Emissions Performance Warranty
- California Emission Control System Limited Warranty

Detailed information about these warranties is listed in the Service and Warranty Information Booklet for US models or in the Warranty and Service Guide Booklet for Canadian models.

We wish you an enjoyable driving experience.

CONTENTS

Using this Owner's Manual

Notes on the Owner's Manual	6
Symbols used	6
Symbol for vehicle parts	6
Your individual vehicle	6
Editorial notice	7
For your own safety	8
Reporting safety defects	9

At a glance

Cockpit	12
Display elements	13
Display elements with navigation system	14
Indicator and warning lamps	15
Multifunction steering wheel MFL	18

Controls and features

Opening and closing:

Keys	22
Central locking system	23
Opening and closing – from outside	23
Opening and closing – from inside	26
Tailgate	27
Electric power windows	28
Sliding/tilt sunroof	29
Roller sun blind	30

Adjustments:

Correct sitting posture	31
Seats	31
Entry to the rear	33
Seat heating	34
Head restraints	34
Safety belts	35
Steering wheel	35
Mirrors	36
Airbags	37
Transporting children safely	38
Vehicle Memory	41

© 2002 Bayerische Motoren Werke
Aktiengesellschaft
Munich, Germany
Reprinting, including excerpts, only with the
written consent of BMW AG, Munich.
Order No. 01 41 0 156 724
US English II/02
Printed in Germany
Printed on environmentally friendly paper
(bleached without chlorine, suitable for recycling).

Driving:

- Ignition lock 42
- Starting the engine 42
- Switching off the engine 43
- Parking brake 44
- Manual transmission 45
- Continuously Variable automatic Transmission (CVT) 46
- Parking lamps/Low beams 49
- Indicator/Headlamp flasher 49
- Instrument lighting 50
- Fog lamps 50
- Interior lamps 50
- Light-emitting diodes 51
- Washer/Wiper system 51
- Cruise control 53

Everything under control:

- Odometer 55
- Tachometer 55
- Fuel gauge 55
- Coolant temperature gauge 56
- Service Interval Display 57
- Clock 57
- Computer 58

Technology for safety and driving convenience:

- Automatic Stability Control plus Traction (ASC+T) 60
- Dynamic Stability Control (DSC) 61
- Flat Tire Monitor 62
- Park Distance Control (PDC) 63

Controlling the climate for pleasant driving:

- Air conditioner system 64
- Automatic climate control 67

Interior conveniences:

- Glove compartment 70
- Ashtray/Beverage holder 70
- Cigarette lighter 70

Loading and transporting cargo:

- Luggage compartment cover 71
- Foldable rear backrest 71
- Loading cargo 72
- Roof-mounted luggage rack 73

Care and maintenance**Special operating instructions:**

- Break-in procedures 76
- General driving notes 76
- Refueling 77
- Fuel specifications 78
- Antilock Brake System (ABS) 78
- Brake system 79

Wheels and tires:

- Tire inflation pressure 80
- Tire condition 82
- Tire replacement 83
- Wheel and tire combinations 84
- Winter tires 85
- Snow chains 85

CONTENTS

In the engine compartment:

Hood 86

Engine compartment –

MINI COOPER 87

Engine compartment –

MINI COOPER S 88

Washer fluid 89

Engine oil 89

Coolant 91

Brake fluid 92

Maintenance and care:

MINI Maintenance System 93

Caring for your vehicle 94

Vehicle immobilization 96

Laws and regulations:

OBD interface socket 96

Technical modifications 96

California Proposition 65 Warning 97

Owner Service Procedures

Replacement procedures:

Onboard tool kit 100

Windshield wiper blades 100

Lamps and bulbs 101

Repairing a flat tire 106

Changing tires – MINI

with space-saver spare tire 106

Flat tire – safety tires 110

Battery 111

Fuses 112

Giving and receiving assistance:

Warning triangle 113

First-aid kit 113

Jump-starting 113

Tow-starting and towing 115

Technical data

Engine data 120

Dimensions 121

Weights 122

Capacities 123

Electrical system 124

Index

Everything from A to Z 128

Notes on the Owner's Manual

In compiling this Owner's Manual we have made every effort to furnish you with a convenient reference source affording quick access to all the essentials. The fastest way to find detailed information on any specific subject is to turn to the comprehensive index at the back of the manual. If you wish to gain an initial overview of your vehicle, you will find this in the first chapter.

Should you wish to sell your MINI at some time in the future, please remember to hand over this Owner's Manual to the new owner; it is an important part of the vehicle.

If you have any additional questions, your MINI center will be glad to advise you.

Symbols used



Indicates precautions that must be followed precisely in order to avoid the possibility of personal injury and serious damage to the vehicle.



Contains information that will assist you in gaining the optimum benefit from your vehicle and enable you to care more effectively for your vehicle.



Refers to measures that can be taken to help protect the environment.

◀ Marks the end of a specific item of information.

* Indicates special equipment, country-specific equipment and optional extras.



Identifies systems or components, which your MINI center can either activate or adapt to suit an individual driver's requirements ("Vehicle Memory"), see page 41.

Symbol for vehicle parts



Indicates that you should consult the relevant section of this Owner's Manual for information on a particular part or assembly.

Your individual vehicle

The manufacturer of your MINI is the Bayerische Motoren Werke Aktiengesellschaft (BMW AG).

On purchasing your MINI, you have decided in favor of a model with individualized equipment and features. This Owner's Manual describes the entire array of options and equipment available with a specific manufacturer model range.

We hope you will understand that equipment and features are included that you might not have chosen for your vehicle. To assist you in identifying possible variations between your own vehicle and the manual's contents, the passages describing optional accessories and special equipment are marked with an asterisk *.

If your MINI features equipment that is not described in this Owner's Manual (a car radio, for instance), we have enclosed additional Owner's Manuals. We ask you to read these manuals as well.

Editorial notice

The manufacturer pursues a policy of continuous, ongoing development that is conceived to ensure that the MINI continues to embody the highest quality and safety standards combined with advanced, state-of-the-art technology. For this reason, it is possible that the features described in this Owner's Manual could differ from those on your vehicle. Nor can errors and omissions be entirely ruled out.

You are therefore asked to appreciate that no legal claims can be entertained on the basis of the data, illustrations or descriptions in this Owner's Manual.

For your own safety

 Use unleaded gasoline only. Fuels containing up to and including 10% ethanol or other oxygenates with up to 2.8% oxygen by weight (i.e. 15% MTBE or 3% methanol plus an equivalent amount of co-solvent) will not void the applicable warranties with respect to defects in materials or workmanship. Field experience has indicated significant differences in fuel quality (volatility, composition, additives, others) among gasolines offered for sale in the United States and Canada. The use of poor-quality fuels may result in driveability, starting and stalling problems especially under certain environmental conditions, such as high ambient temperature and high altitude.

Should you encounter driveability problems which you suspect could be related to the fuel you are using, we recommend that you respond by switching to a recognized high-quality brand.

Failure to comply with these recommendations may result in unscheduled maintenance.

Obey pertinent safety rules when you are handling gasoline. ◀



Important safety information.

For your own safety, use genuine parts and accessories approved by the manufacturer of the MINI.

When you purchase accessories tested and approved by the manufacturer of the MINI and Original MINI Parts, you simultaneously acquire the assurance that they have been thoroughly tested by the manufacturer of the MINI to ensure optimum performance when installed on your vehicle.

The manufacturer of the MINI warrants these parts to be free from defects in material and workmanship.

The manufacturer of the MINI will not accept any liability for damages resulting from installation of parts and accessories not approved by the manufacturer of the MINI.

The manufacturer of the MINI cannot test every product from other manufacturers to verify if it can be used on a MINI safely and without risk to either the vehicle, its operation, or its occupants.

Original MINI Parts, MINI Accessories and other products approved by the manufacturer of the MINI, together with profes-

sional advice on using these items, are available from all MINI centers.

Installation and operation of non-MINI approved accessories such as alarms, radios, amplifiers, radar detectors, wheels, suspension components, brake dust shields, telephones (including operation of any portable cellular phone from within the vehicle without using an externally mounted antenna) or transceiver equipment (e.g. CB, walkie-talkie, ham radio or similar) may cause extensive damage to the vehicle, compromise its safety, interfere with the vehicle's electrical system or affect the validity of the MINI Limited Warranty. See your MINI center for additional information. ◀



Maintenance, replacement, or repair of the emission control devices and systems may be performed by any automotive repair establishment or individual using any certified automotive part. ◀

The following only applies to vehicles owned and operated in the US.

REPORTING SAFETY DEFECTS

If you believe that your vehicle has a defect which could cause a crash or could cause injury or death, you should immediately inform the National Highway Traffic Safety Administration (NHTSA) in addition to notifying BMW of North America, LLC., P.O. Box 1227, Westwood, New Jersey 07675-1227, Telephone (201) 307-4000.

If NHTSA receives similar complaints, it may open an investigation, and if it finds that a safety defect exists in a group of vehicles, it may order a recall and remedy campaign. However, NHTSA cannot become involved in individual problems between you, your dealer or BMW of North America, LLC.

To contact NHTSA, you may either call the Auto Safety Hotline toll-free at 1-800-424-9393 (or 366-0123 in Washington, D.C. area) or write to: NHTSA, U.S. Department of Transportation, Washington, D.C. 20590. You can also obtain other information about motor vehicle safety from the Hotline.

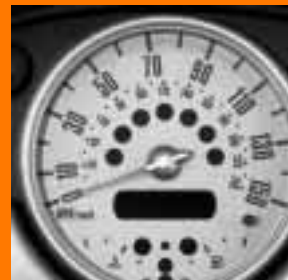

OVERVIEW

OVERVIEW

CONTROLS

CONTROLS

OPERATION, CARE, MAINTENANCE

OPERATION

OWNER SERVICE PROCEDURES

REPAIRS

TECHNICAL DATA

DATA

INDEX

INDEX

COCKPIT

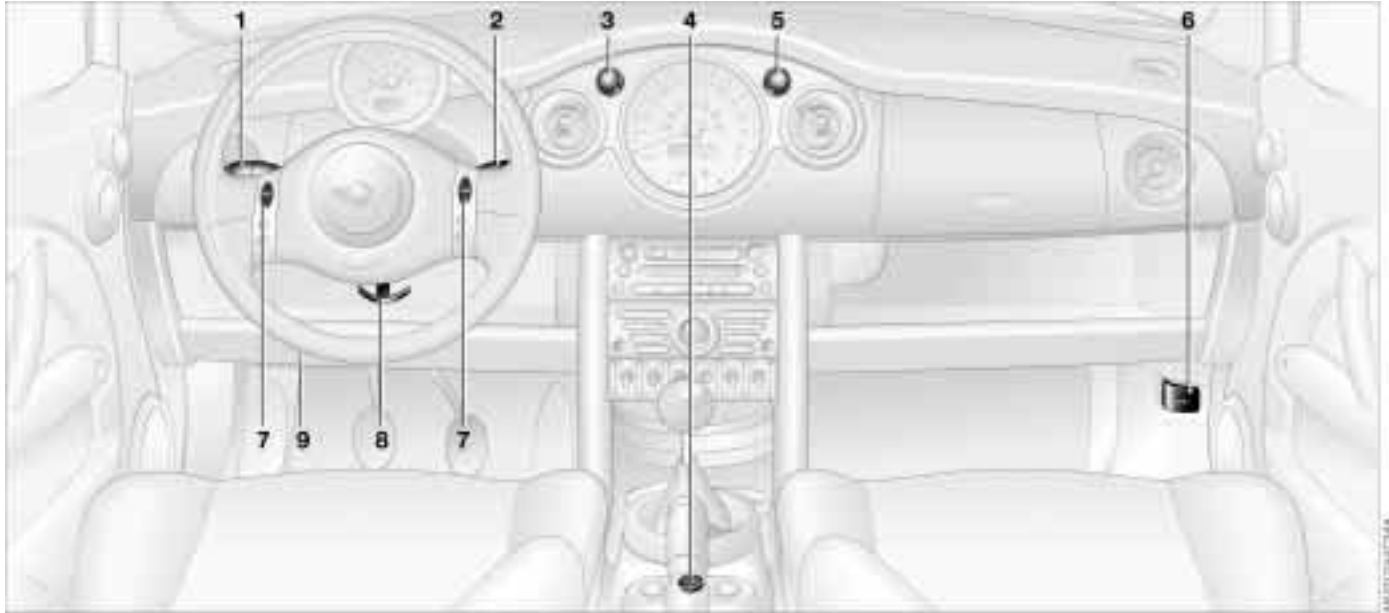

- 1 ▷ Parking lamps/Low beams 49
- ▷ Turn signal indicators 49
- ▷ Standing lamps 49
- ▷ High beams 49
- ▷ Headlamp flasher 49
- ▷ Computer 58

- 2 Washer/Wiper system 51
- 3 Instrument lighting 50
- 4 Outside mirror adjustment 36
- 5 Hazard warning flashers

- 6 Hood release 86
- 7 Horn 18
- 8 Steering wheel adjustment 35
- 9 OBD interface socket 96

DISPLAY ELEMENTS

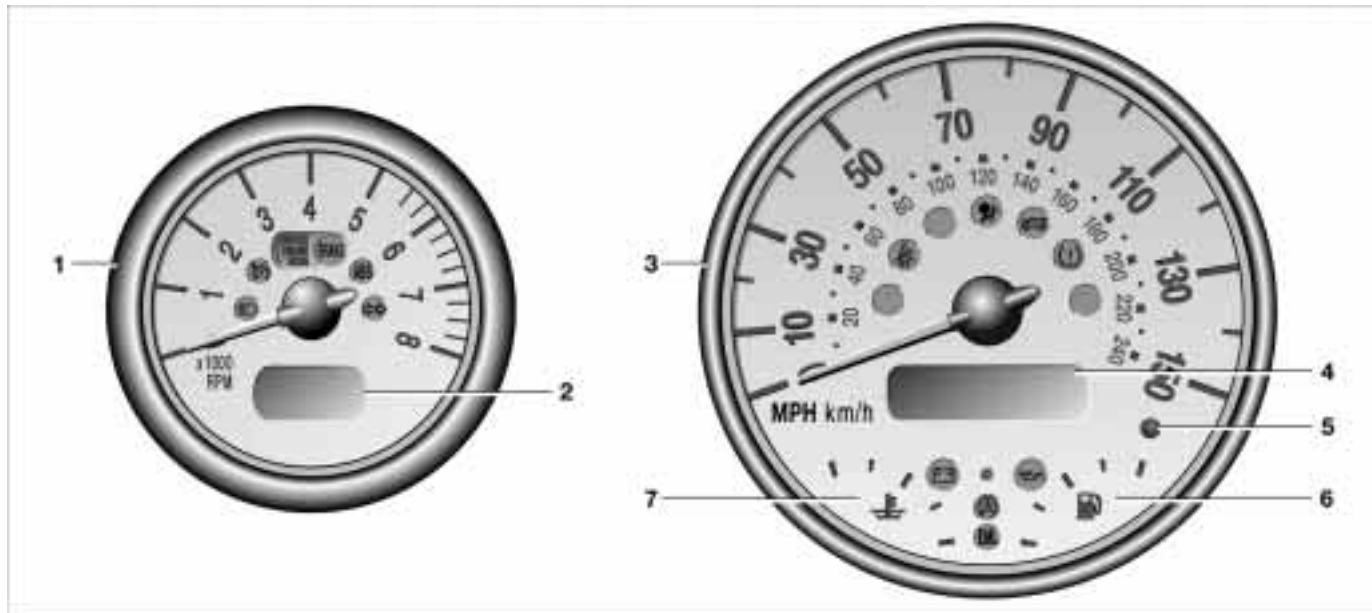

- 1 Tachometer 55
with indicator and warning lamps, see
from page 15
- 2 Display for computer 58
- 3 Speedometer with indicator and warning
lamps, see from page 15

- 4 Indicator for
 - ▷ Odometer 55
 - ▷ Trip odometer 55
 - ▷ Service Interval 57
 - ▷ Program display for Continuously
Variable Transmission (CVT) 48

- 5 Trip odometer, reset to zero 55
- 6 Fuel gauge 55
- 7 Engine coolant temperature gauge 56

DISPLAY ELEMENTS WITH NAVIGATION SYSTEM *

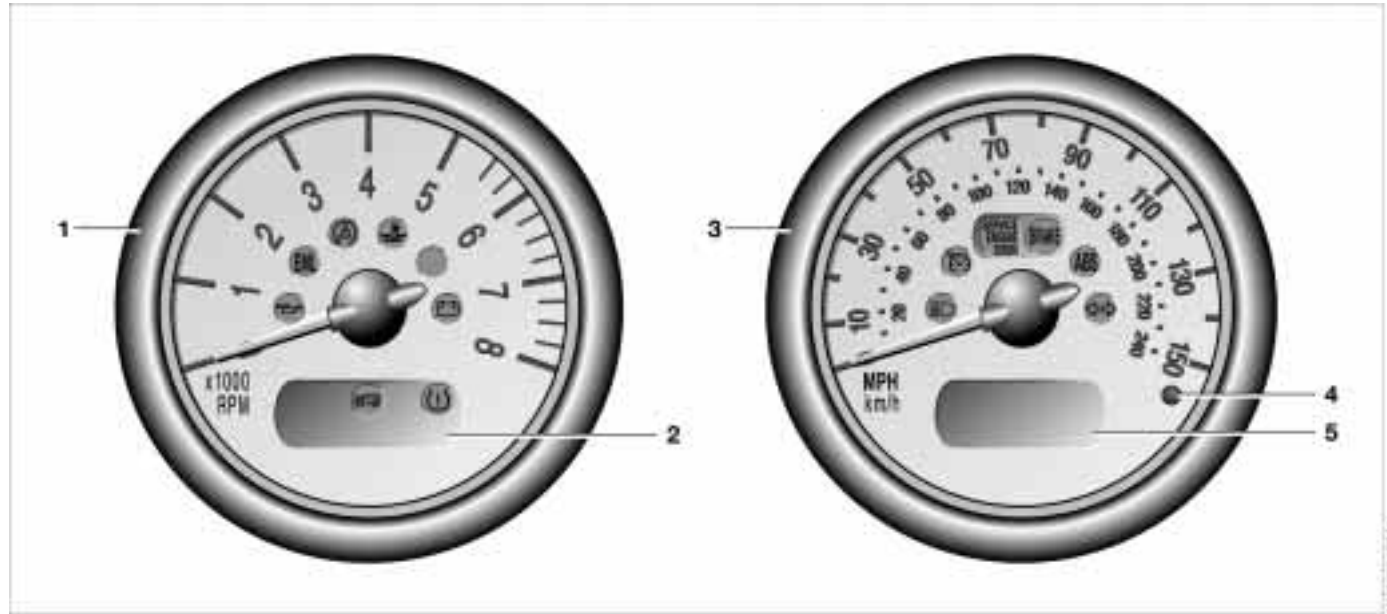

- 1 Tachometer 55
with indicator and warning lamps, see
from page 15
- 2 Display for computer 58

- 3 Speedometer with indicator and warning
lamps, see from page 15
- 4 Trip odometer, reset to zero 55

- 5 Indicator for
- ▷ Odometer 55
 - ▷ Trip odometer 55
 - ▷ Service Interval 57
 - ▷ Program display for Continuously
Variable Transmission (CVT) 48

INDICATOR AND WARNING LAMPS

Technology that monitors itself

The system runs a check on the warning and indicator lamps marked by "●" each time you switch on the ignition. They each light up once for different periods of time.

If a malfunction should occur in one of these systems, the corresponding lamp does not go out after the engine is started or it lights up while the vehicle is moving. You will see how to react correctly to this below.

Red: stop immediately



Battery charge current ●

The battery is no longer being charged. Indicates a defective alternator drive belt or a problem with the charge circuit. Please contact the nearest MINI center.

If this lamp lights up, the power-assist for steering can be deactivated.



If the drive belt is defective, do not continue driving. The engine could be damaged due to overheating. When the power-assist is deactivated, increased steering effort is required. ◀



Engine oil pressure ●

Stop immediately. Switch off engine. Check the engine oil and top up as required. Please contact the nearest MINI center.



Do not continue driving, otherwise, the engine could be damaged because of inadequate lubrication. ◀



Brake warning lamp ●

If the lamp comes on when the parking brake is not engaged: Check the brake fluid level. Before driving further, be sure to comply with the information on pages 79, 57 and 92.



Brake warning lamp for Canadian models.



Coolant temperature warning lamp in the speedometer ●

If the lamp comes on while operating the vehicle, the engine has overheated. Switch off the engine immediately and allow to cool down, see also page 56.

With navigation system option:

INDICATOR AND WARNING LAMPS

Yellow: stop immediately



Flat Tire Monitor ●

Flashes: tire failure.

Reduce speed immediately and stop the vehicle.

With safety (run-flat) tires:

Reduce vehicle speed carefully to under 50 mph (80 km/h).

In both cases, avoid hard brake applications and steering maneuvers. Check the tire inflation pressures.

Conduct in the event of a flat tire, see pages 106, 110.

General information on the system, see page 62

Red and yellow: continue to drive; drive cautiously



Brake warning lamp together with yellow indicator lamps for ABS, EBV and ASC+T/DSC:



The control system ABS, EBV and ASC+T/DSC has failed. Drive cautiously and defensively. Avoid full brake applications. Please have the system checked by your MINI center as soon as possible.



More information on pages 60, 61



Brake warning lamp together with the yellow indicator warning lamps ABS, EBV and ASC+T/DSC for Canadian models.



Red: an important reminder



Brake warning lamp with parking brake applied. More information on the parking brake on page 44



Parking brake lamp for Canadian models.



Fasten safety belts ●
Depending on model, with acoustic signal*. Lights up either for several seconds or until the belt is engaged, depending on version.

More information on page 35



Depending on the level of equipment, the indicator lamp is in the vicinity of the navigation system. ◀



Airbags ●
Please have the system inspected at your MINI center.

More information on pages 31, 37



Depending on the level of equipment, the indicator lamp is in the vicinity of the navigation system. ◀



Hood/tailgate
Lights up when the hood and/or tailgate are open.

More information on pages 27, 86

INDICATOR AND WARNING LAMPS

Yellow: check as soon as possible



Flat Tire Monitor ●

Stays lit: the system is defective. Please have the system inspected at your MINI center.

More information on page 62



Antilock Brake System (ABS) ●

ABS has been deactivated in response to system malfunction.

Conventional braking efficiency is available. Please have the system inspected at your MINI center.

More information on page 78



ABS indicator lamp for Canadian models.



Automatic Stability Control plus Traction (ASC+T)/Dynamic Stability Control (DSC) ●

Indicator lamp flashes:

System active: drive and braking forces are regulated.

The indicator lamp stays lit:

ASC+T/DSC switched off with button or defective. In the event of a defect: please have the system inspected at your MINI center.

More information on pages 60, 61



Service Engine Soon ●

If the warning lamp comes on either continuously or intermittently, this indicates a malfunction in the emissions-related electronic systems. Although the vehicle remains operational, you should have the systems checked by your MINI center at the earliest possible opportunity.



"Service Engine Soon" warning lamp for Canadian models.



Engine electronics* ●

Malfunction in the engine electronics. You can continue to drive with reduced engine output or engine speed. Please have the system inspected at your MINI center.

Green: for your information



Turn signal indicators

Flashes when turn signal indicator is on, also for trailer towing.

Rapid flashing: the system is defective.

More information on page 49



Cruise control*

Lights up when the cruise control is activated. Operation via the multi-function steering wheel.

More information on page 53

Blue: for your information



High beams

Comes on when the high beams are on or the headlamp flasher is actuated.

More information on page 49

MULTIFUNCTION STEERING WHEEL MFL*



The control buttons integrated within the MFL multifunction steering wheel have been designed to allow you to operate a number of accessories both quickly and safely, without taking your eyes from the road:

- ▷ Some audio source functions
- ▷ Cruise control.

The illustration shows the possible full equipment level. For further details, please consult the description of the relevant item of equipment.

Buttons facing the driver

- 1 Cruise control: activate/interrupt/deactivate
- 2 Continue cruise control
- 3 Horn
- 4 Cruise control: store and accelerate (+)
- 5 Cruise control: store and decelerate (-)

Buttons facing away from the driver

Left:

- 1 ▷ Radio
 - Press briefly: scans for stations in FM band
 - Extended pressure: station tuning
- ▷ CD
 - Press briefly: jump to next track
 - Extended pressure: fast forward in track
- ▷ Cassette
 - Press briefly: stop track scan or fast forward
 - Extended pressure: fast forward/rewind

Right:

- 1 Volume
- 2 Switch between radio, cassette and CD



OVERVIEW

OVERVIEW

CONTROLS

CONTROLS

OPERATION, CARE, MAINTENANCE

OPERATION

OWNER SERVICE PROCEDURES

REPAIRS

TECHNICAL DATA

DATA

INDEX

INDEX

KEYS



Depending on the equipment fitted, your MINI has up to three key variations:

- 1 Master key with remote control and battery



If the battery is discharged, please consult your MINI center. Battery changing, see next column. ◀

- 2 Door and ignition key
This key can only be used to open the doors mechanically
- 3 Spare key for storage in a safe place, such as in your wallet. This key is not intended for constant use



Changing battery

Replace it if it is no longer possible to unlock the vehicle via the remote control.



Only use a battery of the type specified on the battery (CR 2032) and make absolutely sure that it is fitted in the correct position. ◀

1. Apply a screwdriver at the recess
2. Use the screwdriver to lever out the cover.



Return used batteries to a recycling point or your MINI center. ◀

Initializing the master key with remote control

When you activate a master key with remote control (replacement, additional key or after a battery change), it must be initialized.

This initialization can be performed in two ways:

Press button 1 or button 2, see page 24, four times in succession

or

if the vehicle is unlocked:

1. Switch the ignition on briefly (position 2) and then off
2. Within 10 seconds, press button 1 and button 2, see page 24, in succession.



In the event of a system malfunction, please contact your MINI center. You can also obtain replacement keys and batteries there. ◀

CENTRAL LOCKING SYSTEM

The concept

The central locking system is ready for operation whenever the driver's door is closed. The doors, the tailgate and the fuel filler door are unlocked or locked.

The central locking system can be operated:

- ▷ From outside via the remote control as well as via the door lock
- ▷ From inside by pressing a button.

If operated from outside, the anti-theft system is activated at the same time. This prevents the doors from being unlocked via safety lock buttons or door handles.

In the event of an accident, the central locking system unlocks automatically. The hazard warning system and interior lamps are also switched on.

OPENING AND CLOSING – FROM OUTSIDE

Via remote control

The remote control gives you an exceptionally convenient method for unlocking and locking your vehicle. It also offers another function:

To open the tailgate, refer to page 24.

The tailgate will open slightly, regardless of whether it was locked or unlocked.

Whenever you unlock (lock) the vehicle, you simultaneously deactivate (activate) the anti-theft system, and switch the interior lamps on (off).

If the vehicle has been properly locked using the remote control, the hazard warning system lights up once. When the vehicle is unlocked, the hazard warning system does not react.



Children might be able to lock the doors from the inside. Always take the vehicle keys with you so that the vehicle can be opened again from the outside at any time. ◀

For US owners only

The transmitter and receiver units comply with part 15 of the FCC (Federal Communication Commission) regulations. Operation is governed by the following:

FCC ID: LX8765S
LX8765E
LX8CAS

Compliance statement:

This device complies with part 15 of the FCC Rules. Operation is subject to the following two conditions:

- ▷ This device may not cause harmful interference, and
- ▷ this device must accept any interference received, including interference that may cause undesired operation.



Any unauthorized modifications or changes to these devices could void the user's authority to operate this equipment. ◀

OPENING AND CLOSING – FROM OUTSIDE

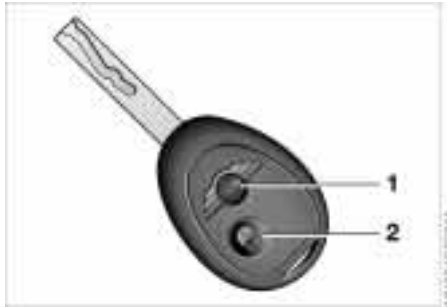

- 1 Unlocking and opening the tailgate
- 2 Locking and securing

 If the remote control does not react, the battery is discharged.

In the event of a system malfunction, please contact your MINI center. You can also obtain replacement keys and batteries from your MINI center.

Battery changing, see page 22. ◀

To unlock

1. Press button 1 once to unlock the driver's door only
2. Press button 1 a second time to unlock the other door as well as the tailgate and the fuel filler door.

When the vehicle is unlocked, the hazard warning system does not react.

To open the tailgate

Hold button 1 pressed for approx. five seconds.

The tailgate will open slightly, regardless of whether it was previously locked or unlocked.

 Before and after a trip, be sure that the tailgate was not opened unintentionally. ◀

To lock and secure

Press button 2.

The hazard warning system flashes once.

 Do not lock the vehicle if there are passengers still inside, because they cannot unlock the doors. ◀

Non-MINI systems

External systems or devices may cause local interference in the functions of the remote control.

In this case, use the master key to unlock the door lock.

OPENING AND CLOSING – FROM OUTSIDE



Manual operation

(in the event of electrical malfunction)

Turn the key to the extreme left or right to unlock/lock the door.

Via the door lock

1. One turn of the key in the driver's door lock unlocks the driver's door only
2. Turning the key a second time unlocks the other door, the tailgate and the fuel filler door.

If the vehicle has been properly locked, the hazard warning system flashes once.

When the vehicle is unlocked, the hazard warning system does not react.



Do not lock the vehicle if there are passengers still inside, because they cannot unlock the doors. ◀

Convenience feature via door lock

You can also operate the power windows and the sliding/tilt sunroof via the door lock.

- ▷ To open: with the door closed, turn the key to the "Unlock" position and hold it
- ▷ To close: with the door closed, turn the key to the "Lock" position and hold it.



Watch during the closing process to be sure that no one is injured. Releasing the key stops the operation. ◀

OPENING AND CLOSING – FROM INSIDE

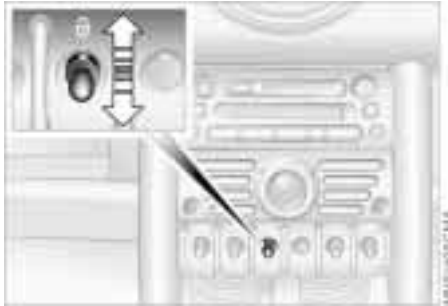

With this switch, you operate the central locking system when the doors are closed. The doors and tailgate are unlocked or locked only.

The anti-theft system is not activated. Also, the fuel filler door remains unlocked to allow refueling.

 If the remote control has been used to unlock only the driver's door, see page 24, and you touch the switch when the driver's door is open, the other door, the tailgate, and the fuel filler door are unlocked.

If the driver's door is closed, touching the switch locks it. ◀



The central locking system can be locked automatically as soon as you begin to drive if you desire. This can be adjusted to be vehicle-specific. ◀

To unlock and open the doors

1. Touch the switch for the central locking system
 2. Pull the door handle above the armrest
- or
- pull the door handle for each door twice: to unlock first and then open.

Convenience opening mode

From ignition key position 1:

Hold the switch in the "Unlock" position. The windows and sliding/tilt sunroof open.



Convenience closing is not possible by means of the central locking system. You should therefore close all the windows and the sliding/tilt sunroof individually. ◀

To lock

Touch the switch for the central locking system

or

press the individual safety lock buttons down.



Children might be able to lock the doors from the inside. Always take the vehicle's keys with you so that you can open the vehicle again from the outside at any time. ◀

TAILGATE



Opening from outside

Press the button in the handle.

The tailgate opens slightly.

Opening with the remote control, see page 24.



Manual operation

In the event of an electrical malfunction, you can also operate the tailgate manually.

3. Fold the rear seat bench upwards
4. Pull the ring.

The tailgate is unlocked.



Closing

The handle recesses in the interior trim panel of the tailgate make it easier to pull the lid down.

 To avoid injuries, be sure that the travel path of the tailgate is clear when it is closed, as with all closing procedures.

Operate the vehicle only when the tailgate is closed. Otherwise, exhaust fumes could penetrate the interior of the vehicle.

Should it be absolutely necessary to operate the vehicle with the tailgate open:

1. Close all windows. Shut the sliding/tilt sunroof
2. Sharply increase the air supply for the air conditioning or automatic climate control, see pages 64 and/or 67. ◀

ELECTRIC POWER WINDOWS

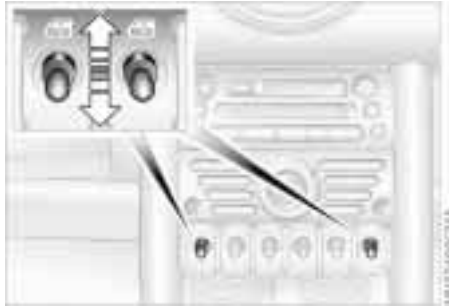

Open and close windows

From ignition key position 1:

To open:

Press the switch downwards.
The window opens until you release the switch

or

briefly press the switch downwards.
The window opens automatically.
Pressing the switch again stops the operation.

To close:

Press the switch upwards.
The window closes until you release the switch

or

when the engine is running:

Briefly press the switch upwards.
The window closes automatically.
Pressing the switch again stops the operation.



The window on the front passenger side cannot be closed automatically. ◀



Watch during the closing process to be sure that no one is injured. ◀

After the ignition has been switched off:

You can use the electric power windows as long as no one opens any of the doors. If a door is opened during operation, the opening/closing process stops immediately.



When leaving the vehicle, always remove the ignition key from the lock and remember to close the doors to prevent children from operating the power windows and injuring themselves, etc. ◀

For the convenience mode via the door lock, refer to page 25.

SLIDING/TILT SUNROOF*

 To prevent injuries, exercise care when closing the sliding/tilt sunroof and keep it in your field of vision until it is shut.

When leaving the vehicle, always remove the ignition key from the lock and remember to close the doors to prevent children from operating the sunroof and injuring themselves, etc.

Be sure that adequate clearance is maintained for the opening path of the sliding/tilt sunroof, otherwise damage can occur. ◀

For the convenience mode via the door lock, refer to page 25.



Raising – Opening – Closing

From ignition key position 1:

To raise:

Press the switch

or

push the switch backwards to the resistance point.

Opening and closing

1. Push the switch in the desired direction until you feel resistance and hold in this position
2. Release the switch when the desired position has been reached.

 Do not use force to close the sliding/tilt sunroof in its raised position, as damage to the mechanism could result. ◀

After the ignition has been switched off:

You can still operate the sliding/tilt sunroof for up to one minute, as long as no one opens any of the doors.

If a door is opened during operation, the opening/closing stops immediately.

Automatic opening and closing

To open:

Push the switch past the resistance point:
The sunroof opens completely

To close:

1. Push the switch past the resistance point:
The sunroof closes to the raised position
2. Push the switch again:
The sunroof closes completely.

Touching the switch briefly during opening or closing stops the movement immediately.

SLIDING/TILT SUNROOF*

Safety feature

As of approximately the middle of the roof opening, if the sliding/tilt sunroof encounters resistance during closing, the closing operation is interrupted and the sunroof opens again slightly.

 Despite this safety feature, be extremely careful that the closing path of the sunroof is not obstructed whenever it is closed. Otherwise, triggering the closing-force limitation may not be ensured in some situations (with very thin objects, for instance). You can override this safety feature by pressing the switch beyond the resistance point and holding it. ◀



Manual opening and closing

In the event of an electrical malfunction, you can also operate the sliding/tilt sunroof manually:

1. Push the clock towards the interior and remove
- 2 Use an Allen wrench to turn the sliding/tilt sunroof in the desired direction.

ROLLER SUN BLIND*



1 Opening

1. Press the button in the handle, see arrow 1.
The cap is unlocked
2. Guide the roller sun blind towards the back.

2 Closing

1. Use the handle to pull the roller sun blind forwards
2. Engage the handle in the device, see arrow 2.

CORRECT SITTING POSTURE

The ideal seating position can make a vital contribution to relaxed, fatigue-free driving. The correct seating position also works together with the safety belts and airbags to provide occupants with maximum levels of passive safety in an accident. To ensure that the safety systems operate with optimal efficiency, we strongly urge you to observe the instructions contained in the following section.

For supplementary information on transporting children, refer to page 38.

Sitting correctly with airbags

 Always maintain an adequate distance between yourself and all of the airbags. Always hold the steering wheel by the rim with the hands at the 9 and 3 o'clock positions to keep any chance of injury to hands or arms to an absolute minimum, should the airbag be deployed. No one and nothing is to come between the airbags and the seat occupant. Never use the front passenger airbag cover as a storage surface for objects of any kind, or as a support for legs or feet, as this will increase the risk of injury in a collision severe enough in which the airbag will deploy. ◀

For airbag locations and additional information on airbags, refer to page 37.

Safe with safety belts

 Never allow more than one person to wear a single safety belt. Never allow infants or small children to ride in a passenger's lap. Avoid twisting the belt while routing it firmly across the hips and shoulder, wear it as snugly against your body as possible. Do not allow the belt to rest against hard or fragile objects. Do not route the belt across your neck, or run it across sharp edges. Be sure that the belt does not become caught or jammed. Avoid wearing bulky clothing that prevents the belt from fitting properly, and pull on the belt periodically to retension it over your shoulders. In the event of a frontal impact, a loose lap belt could slide over the hips, leading to abdominal injury. In addition, the safety belt's restraint effectiveness is reduced if the belt is worn loosely. Expectant mothers should always wear their safety belts, taking care to position the lap belt against the lower hips, where it will not exert pressure against the abdominal area. ◀

For information on using the safety belts, refer to page 35.

SEAT ADJUSTMENT

Important adjustment information

 Never try to adjust your seat while operating the vehicle. The seat could respond with an unexpected movement, and the ensuing loss of vehicle control could lead to an accident. Never ride with the backrest reclined to an extreme horizontal angle (especially important for front passengers to remember). Keep the backrest relatively upright to minimize the risk of sliding under the safety belt and sustaining injury in an accident. ◀

Adjusting the seats, see next page.

SEAT ADJUSTMENT

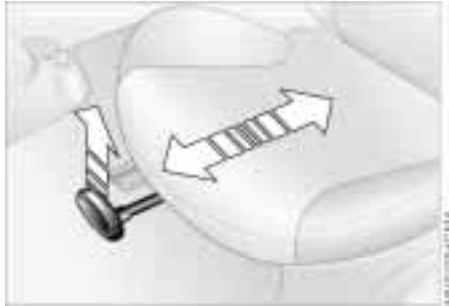

Longitudinal seat adjustment

1. Lift the handle
2. Push the seat into the desired position
3. After releasing the handle, apply pressure to the seat to ensure that the latch engages securely.

 Make corrections in the longitudinal adjustment of the seat to ensure that the safety belt still fits firmly against your body. If you do not do this, the protection provided by the safety belt may be reduced. ◀

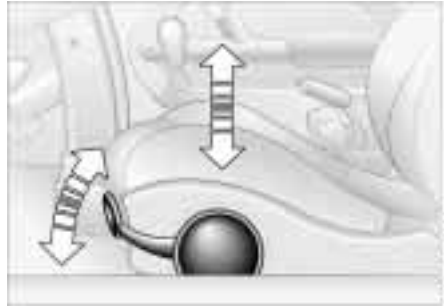

Seat height

1. To raise:
Pull the handle up repeatedly, continuing until the seat reaches the desired height
2. To lower:
Push the handle repeatedly, continuing until the seat reaches the desired height.



Lumbar support*

You can adjust the contour of the backrest for additional support in the curvature of your spine's lumbar region. The upper hips and spinal column receive supplementary support to help you maintain a relaxed, upright posture. Turn the wheel to increase or decrease the curvature.

SEAT ADJUSTMENT



Backrest tilt

1. Pull the lever at the inside of the seat
2. Apply weight to or remove weight from the backrest as required
3. Release the lever so that the backrest locks into place.

ENTRY TO THE REAR



Easy Entry

1. Press the lever on the outside of the seat downwards, see arrow 1.
The backrest folds forward automatically
2. Push the seat forwards, see arrow 2.

Original position

1. Push the seat back into its home position
2. Fold the backrest back to the home position to lock the seat.

 When returning the seat to the rear position, ensure that no one is injured and that no objects are damaged. Engage and lock both seats and backrests into position prior to driving, otherwise unexpected movement could increase the risk of accident. ◀

HEATED SEATS*



The seat cushion and backrest can be heated with the ignition key in position 2.

Select the temperature setting:
Press each button briefly.

Direct deactivation from second temperature setting.
Press the button for a longer period.

HEAD RESTRAINTS

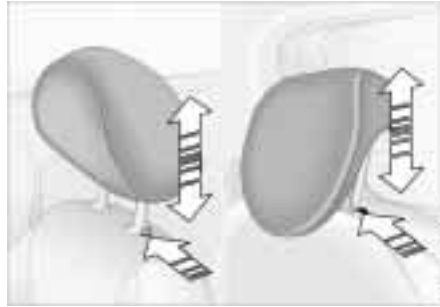

Adjusting the head restraints

To raise: pull the head restraint upward.

To lower: press the button and push the head restraint downward.

 You can reduce the risk of spinal injury and whiplash by adjusting the head restraint to a height at which it is centered roughly at ear level. ◀

Removal

1. Pull up the head restraint, continuing until it is at maximum extension
2. Press the button and remove the head restraint at the same time.

Installation

1. Press the button and at the same time insert the head restraint in the reception points
2. Adjust the head restraint.

 To avoid possible violation of traffic laws, never retract the head restraints unless the rear seats are empty. Always ensure that the head restraints are raised before transporting passengers in the rear seat. ◀

SAFETY BELTS

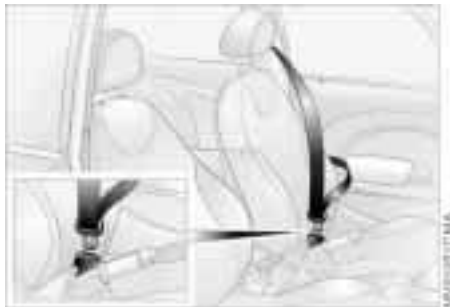

Drive with your safety belt on

Even though there is an airbag, wear a safety belt every time you get in the vehicle, because airbags enhance safety by providing added protection.

To fasten

Make sure you hear the lock engage in the belt buckle.

To release

1. Press the red button in the belt buckle
2. Hold the belt
3. Guide the belt back into its reel.

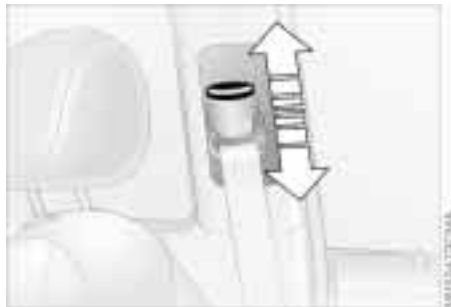

Safety belt height adjustment

Use the height adjustment mechanism to adapt the safety belt to the ideal position for your own body:

Press the button and at the same time push the entire unit upwards or downwards.

Also observe the instructions on adjusting the seats on page 31.

 If the safety belts are damaged or stretched in an accident: have the safety belt system replaced by your MINI center and the belt anchors checked, otherwise the safety function can no longer be guaranteed. If a child-restraint system was in the vehicle during an accident, consult the manufacturer's instructions regarding replacement. ◀

STEERING WHEEL



To adjust the steering wheel height

1. Push the locking lever downward
2. Adjust the desired steering wheel position
3. Pull the lever back in.

 Do not adjust the steering wheel while the vehicle is moving, otherwise unexpected movement could increase the risk of accident. ◀

MIRRORS



Manual adjustment

The mirrors can also be adjusted manually:
Press the edge of the lens.

Electric heating*

Both mirrors are heated automatically when the ignition key is in position 2.

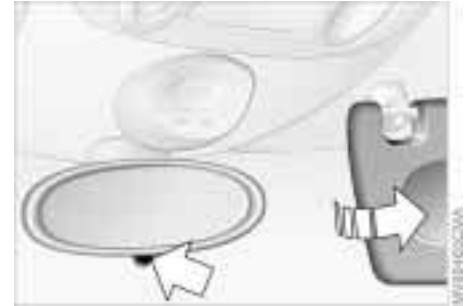

Adjusting exterior mirrors

- 1 Switch for choosing between the left and right mirror
- 2 Switch for 4-way adjustment.

Interior rearview mirror

To reduce glare from vehicles behind you when you are driving at night:
Tilt the lever forward.

Illuminated vanity mirror

From ignition key position 1:

1. Fold down the sun visor
2. Fold the cover panel upwards.

Sun visors

Can be swung sideways.

MIRRORS

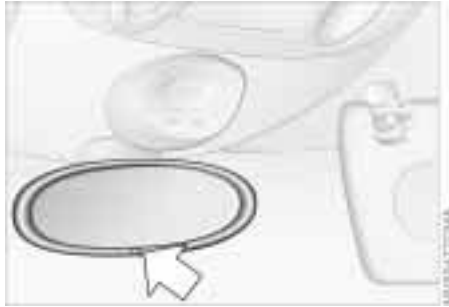

Interior rearview mirror, automatic dimming feature*

The mirror dims automatically as required. The mirror becomes clear again when you engage reverse gear or select selector lever position R.

Keep the photocells free and clean to ensure that the mirror functions perfectly. There is one photocell in the mirror frame; the other is on the back of the mirror.

 Do not cover the area between the inside rearview mirror and the windshield, and do not place stickers or toll tags on the windshield in front of the mirror. ◀

AIRBAGS

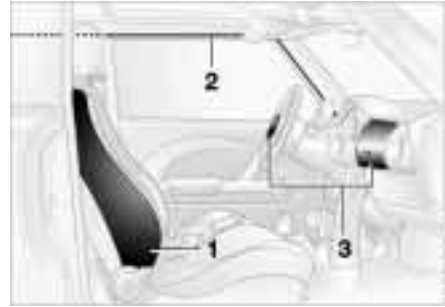

- 1 Side airbags in seats on the driver and passenger sides (front)
- 2 Head airbags on the driver and passenger sides for both rows of seats (front/rear)
- 3 Front airbags on the driver and passenger sides

Protective effect

The front airbags supplement the safety belts by helping to provide additional protection for the driver and front passenger in the event of a frontal collision in which the protection afforded by the belts alone may no longer be sufficient. When needed, the head and side airbags help to furnish protection in the event of side impact. Each of the side airbags is

designed to help support the seat occupant's upper body.

For information on sitting posture, refer to page 31.

 The airbags do not deploy in response to minor collisions, rear impacts and certain kinds of vehicle rollover. ◀

Even when all safety guidelines are observed, there is a small residual risk that passengers will sustain facial, hand or arm injuries in isolated instances. The ignition and inflation noise may induce a mild temporary hearing loss in sensitive individuals.

 Do not apply adhesive materials to the cover panels of the airbags, cover them or modify them in any other way. Do not fit covers, cushions or other items to the front seats that have not been specially approved for seats with side airbags. Do not hang clothing, e.g. jackets, over the backrests. Do not attempt to remove the airbag restraint system from the vehicle. In the event of malfunctions, immobilization or use (triggering) of the airbag restraint system in accordance with its intended function, only commission a MINI center with the inspection, repair or disassembly.

AIRBAGS

Do not make any changes yourself to the individual components and wiring. This includes the padded cover of the steering wheel, in the instrument panel and the roof supports, as well as the sides of the roof-liner and the original backrest covers on the front seats. Do not attempt to remove or dismantle the steering wheel. In view of the applicable safety regulations, arrange for your MINI center to dispose of the airbag generators. Unprofessional attempts to service the system could lead to failure in an emergency or undesired airbag activation, either of which could result in personal injury. Do not touch the individual components directly after the system has been triggered, as otherwise there is a danger of burns. ◀



At all times, occupants should sit upright and be properly restrained (infants and small children in appropriate child-restraint systems; larger children and adults using the safety belts). Never let an occupant's head rest near or on a head airbag because the inflating airbag could cause serious or fatal injury. A child which is not properly restrained could place his or her head on or near the airbag. ◀

Indicator lamp



The indicator lamp on the instrument panel shows the airbag system status starting from ignition position 1.

System operational:

▷ The indicator lamp comes on briefly.

System malfunction:

▷ The indicator lamp does not come on

▷ The indicator lamp fails to go out after the engine has been started, or it comes on during normal driving.

A system defect could prevent the airbags from deploying in response to a severe impact occurring within the system's normal triggering range.

Have the system checked as soon as possible by your MINI center.

TRANSPORTING CHILDREN

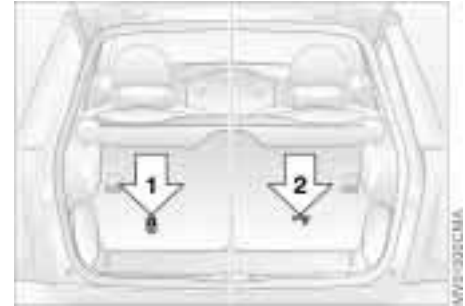

Children younger than 13 years and/or smaller than 5 ft (150 cm) should only travel in the rear in suitable restraint systems.

Commercially-available child-restraint systems are designed to be secured with a lap belt or with the lap belt portion of a combination lap/shoulder belt. Improperly or inadequately installed restraint systems can increase the risk of injury to children. Always read and follow the instructions that come with the system.

If you use a child-restraint system with a tether strap:

TRANSPORTING CHILDREN SAFELY

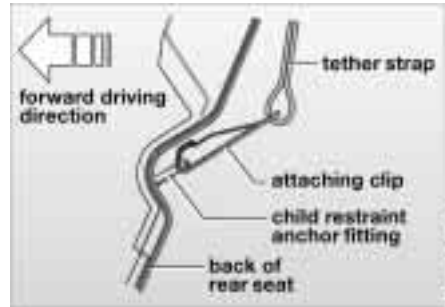
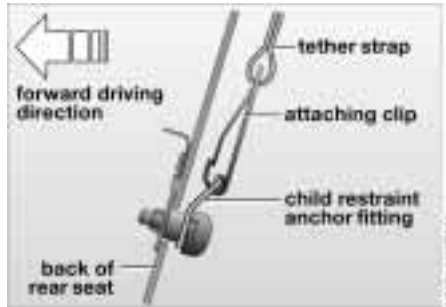

Your vehicle has one of two different types of child-restraint anchor fittings on the back of the rear seats, see arrows 1 or 2.

Depending on the location selected for seating in the rear passenger area, attach the tether strap to the corresponding anchorage point to secure the child-restraint system.

Adjust the tether strap according to the child restraint manufacturer's instructions.



Anchor fitting 1 is shown above.

Anchor fitting 2 is shown in the next column. ◀

Both seating positions are fitted with a head restraint. Lift the head restraint and pass the tether strap between the head restraint and the seat back. It is recommended to readjust the head restraint into the lowest possible position.



Adjust the tether strap according to the child restraint manufacturer's instructions. Before installing any child-restraint device or child seat, please read the following:

Never install a rearward-facing child-restraint system in the front passenger seat of this vehicle.

Your vehicle is equipped with an airbag supplemental restraint system for the front passenger. Because the backrest on any rearward-facing child-restraint system – of the kind designed for infants under 1 year and 20 lbs./9 kg – would be within the airbag's deployment range, you should never mount such a device in the front passenger seat, since the impact of the airbag against the child restraint's backrest could lead to serious or fatal injuries. If it is necessary for a child – not an infant – to ride in the front seat, certain precautions should be taken. First, move the passenger seat as far away from the instrument panel as possible. This important precaution is intended to maximize the distance between the airbag and the child. Older children should be tightly secured with a safety belt, after they have outgrown a booster seat that is appropriate for their age, height and weight. Younger children should be secured in an appropriate

TRANSPORTING CHILDREN SAFELY

forward-facing child-restraint system that has first been properly secured with a safety belt. Never install a rearward-facing child-restraint system in the front passenger seat.

We strongly urge you to carefully read and comply with the instructions for installation and use provided by the child restraint's manufacturer whenever you use such a device.

Be sure that all occupants – of all ages – remain properly and securely restrained at all times.

According to accident statistics, children are safer when properly restrained in the rear seats than in the front seating positions. ◀

All rear seats in your vehicle conform to the guidelines defined in SAE J1819, an industry recommended practice for securing child-restraint systems in motor vehicles.



Child seat security

All of the rear belt retractors and the front passenger's safety belt can be locked for mounting and securing child-restraint systems.

Information regarding this is located near the buckle latch of each safety belt.

To lock the belt

Pull the entire length of the belt from the belt retractor. Allow the reel to retract the belt somewhat and engage the buckle, then tighten the belt against the child-restraint system. The retraction mechanism is now locked.

To unlock the belt

Release the buckle, remove the child-restraint system and allow the belt retractor to reel the belt completely in.

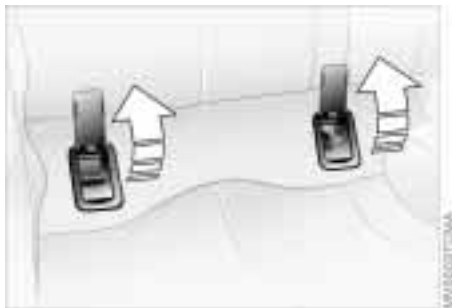

LATCH child-restraint system

Open the cover.

The illustration is an example showing the mounts for the LATCH (Lower Anchors and Tethers for Children) child-restraint mounting system at the right rear.

The system is also available at the left rear position.



Always follow all manufacturer's instructions and observe all safety precautions when installing the LATCH child-restraint system. ◀

How the system functions

Doubtless you have often reflected on how great it would be if you could configure your vehicle's various adjustment settings to meet your own personal requirements. In developing this vehicle, the manufacturer has incorporated a number of options that your MINI center can program to reflect your individual preferences.

What the system can do

Your MINI center can provide you with details on the capabilities of the Vehicle Memory system.

Examples for Vehicle Memory:

- ▷ Signals an acknowledgement when locking or unlocking your vehicle
- ▷ Automatic locking after starting off
- ▷ Automatic unlocking when the parking brake is applied
- ▷ Selective central locking
First open the driver's door, then the whole car
- ▷ Automatic opening/closing of sliding/tilt sunroof
- ▷ Opening/closing windows and/or sliding/tilt sunroof via remote control
- ▷ Speed-dependent windshield wiper

- ▷ Automatic activation of windshield wipers on cleaning
- ▷ "Follow me home" lamps
Low beams light up for a short time after the engine has been switched off
- ▷ Locking when engine is running (with second key)
- ▷ Stop function of power windows on opening/closing
- ▷ Activating/deactivating daytime driving lamps*
- ▷ Switching on interior lamps via remote control.



This symbol draws your attention to other Vehicle Memory functions described in the Owner's Manual. ◀

IGNITION LOCK

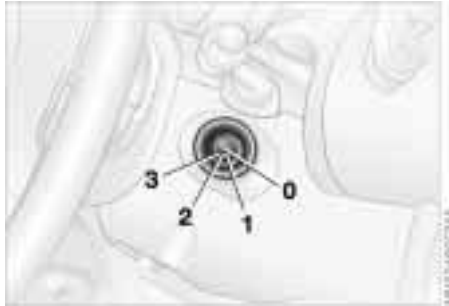

- 0 Steering locked
- 1 Steering unlocked
- 2 Ignition switched on
- 3 Starting the engine

0 Steering locked

The key can be inserted or removed in this position only.

To lock the steering:

1. Remove the key
2. Turn the steering wheel slightly to the left or right until the lock engages.



Vehicles with Continuously Variable automatic Transmission (CVT):

Do not move the selector lever from position "P" until the engine is running. Your vehicle is equipped with an interlock. Therefore, the ignition key cannot be turned to position 0 and removed until the selector lever is in position "P" (Interlock). ◀

1 Steering unlocked

Individual electrical accessories are ready for operation.

You will find that it is often easier to turn the ignition key from position 0 to position 1 when you move the steering wheel slightly to help disengage the lock.

2 Ignition switched on

All electrical accessories are ready for operation.

3 Starting the engine



Vehicles with manual transmission: Step on the clutch when starting the vehicle. A lockout prevents the engine from starting if the clutch is not depressed. ◀

STARTING THE ENGINE

Do not allow the engine to warm up with the vehicle at a standstill. Move off immediately at a moderate engine speed.



Do not allow the engine to run in enclosed spaces. The exhaust gases contain carbon monoxide, an odorless and colorless, but highly toxic gas. Breathing the exhaust gases poses an extreme health risk, and can lead to unconsciousness and death.

Do not leave the vehicle unattended with the engine running. An unattended vehicle with a running engine represents a potential safety hazard. When driving, standing at idle or when parking, take precautions to avoid contact between the hot exhaust system and easily flammable materials (grass, hay or leaves, for example). Such contact could lead to a fire, resulting in serious personal injury and property damage. ◀

STARTING THE ENGINE

Starting

When starting the engine, do not press the accelerator pedal.



Do not actuate the starter for too short a time. Do not turn it for more than approx. 20 seconds. Release the ignition key immediately when the engine starts.

Extended starting attempts, characterized by excessively frequent or long periods with the starter engaged, can lead to damage in the catalytic converter. ◀

If the engine does not start on the first attempt (the engine is very hot or cold, for instance):

- ▷ Press the accelerator pedal halfway down while engaging the starter.

Cold starts at extremely low temperatures (as of approx. +5 °F (-15 °C)):

- ▷ Press the accelerator pedal halfway down while engaging the starter
- ▷ For the initial start attempt, allow the starter to remain engaged somewhat longer (approx. 10 seconds).

Manual transmission

1. Engage the parking brake
2. Put the manual gearshift lever in neutral
3. Press the clutch pedal
4. Start the engine.

Continuously Variable automatic Transmission (CVT)*

1. Press the footbrake
2. Put the selector lever in position P or N
3. Starting the engine.



Move the selector lever to position N and engage the parking brake before leaving your vehicle with the engine running.

Do not leave the vehicle with the engine running. An unattended vehicle with a running engine represents a potential safety hazard. ◀

SWITCHING OFF THE ENGINE



You should never remove the ignition key when the vehicle is in motion, as the steering lock could engage.

When you leave the vehicle, always remove the ignition key and engage the steering lock.

When you park on downward slopes, engage the parking brake. ◀

Manual transmission

Turn the ignition key to position 1 or 0.

Continuously Variable automatic Transmission (CVT)*

Engage selector lever position P, turn the ignition key to position 1 or 0.

PARKING BRAKE



The parking brake is designed primarily to prevent the vehicle from rolling when it is parked. It operates against the rear wheels.

To engage

Lever automatically locks in position. The warning lamp in the instrument cluster comes on when the ignition key is in position 2, see page 16.

To release

1. Pull up slightly
2. Press the button
3. Push the lever downwards.

 If, in exceptional circumstances, it should be necessary to engage the parking brake while the vehicle is in motion, do not pull the lever with excessive pressure. Keep your thumb pressed against the release button while carefully pulling the lever up to apply moderate pressure.

Excessive pressure can lead to overbraking and loss of traction (fishtailing) at the rear axle.

The brake lamps do not come on when the parking brake is engaged.

Vehicles with manual transmission:

Always engage the parking brake when parking on hills and inclined surfaces, as first gear or reverse may not provide adequate resistance to rolling.

Vehicles with CVT:

Place the selector lever in P. ◀

MANUAL TRANSMISSION

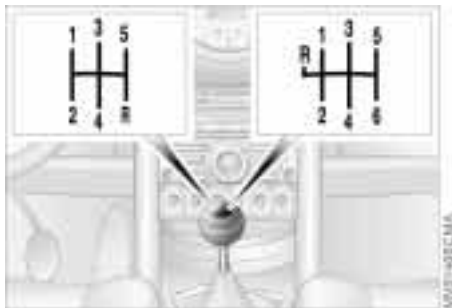

The manual gearshift lever neutral plane lies in the gear plane of the 3rd/4th gear. When shifting from each gear into "Neutral", the manual gearshift lever springs back automatically into the gearshift lever neutral plane.

6-speed transmission*

 When changing gear in the 5th/6th gear plane, press the gearshift lever to the right to prevent shifting to a gear of the 3rd/4th gear plane. ◀

Reverse

Before selecting reverse gear, ensure the vehicle is stationary; then, fully press the clutch pedal and pause briefly before moving the gearshift lever into position.

As you do this, the backup lamps will turn on automatically when the ignition key is in position 2.

5-speed transmission:

Press the gearshift lever to the right and to the back.

6-speed transmission:

Press the gearshift lever to the left to overcome the slight resistance and press forwards.

As you do this, the backup lamps will turn on automatically when the ignition key is in position 2.



Do not hold the vehicle in place on slopes by slipping or "riding" the clutch. Use the parking brake instead. Riding the clutch causes the clutch assembly to wear out sooner. ◀

CONTINUOUSLY VARIABLE AUTOMATIC TRANSMISSION (CVT)*

You can drive with a steplessly shifting CVT. In addition, you can also shift manually.

When you move the selector lever from the D position to the right into the M/S + – range, the performance-oriented shift programs of the CVT are engaged. Step-tronic enters the manual selection mode and executes the desired shift whenever you tap the selector lever in the direction indicated by "+" or "-".

Whenever you want to use automatic again, just move the selector lever toward the left to position D.

 In position D, you achieve the lowest fuel consumption for average driving. ◀



Selector lever positions

P R N D M/S + –

Range selection

Inadvertent engaging of certain selector lever positions is prevented by a lock.

Press the button on the front side of the selector lever knob. The lock is released.

 While the vehicle is stationary and before shifting out of P or N, press the brake pedal in order to disengage the selector lever lock mechanism (Shiftlock). If the engine speed is too high when the vehicle is at a standstill, the selector lever is also blocked to protect the transmission. Hold the brake pedal down until starting off. Otherwise the vehicle will "creep" when a drive position is engaged. ◀

 To prevent the vehicle from starting off on its own, always move the selector lever to position P or N and engage the parking brake before leaving your vehicle with the engine running. Do not leave the vehicle unattended with the engine running. An unattended vehicle with a running engine represents a potential safety hazard. ◀

 If the selector lever is not placed in position P when the vehicle is parked, the position display of the selector lever stays on. This can lead to battery discharge. ◀

CONTINUOUSLY VARIABLE AUTOMATIC TRANSMISSION (CVT) *

P Park

Select "P" only when the vehicle is completely stopped. Transmission locks to prevent rear wheels from turning.

R Reverse

Select "R" only when the vehicle is completely stopped.

N Neutral

Select "N" only if your journey is interrupted for a long period.

D Drive (CVT driving position)

This position is designed for driving under all normal operating conditions.

"Kickdown"

In "kickdown", you achieve maximum acceleration and maximum speed in position D.

Press the accelerator pedal past the increased resistance point at the full-throttle position.



M/S + – Manual mode and Sport program

Switch from D into M/S + –:

Activates the Sport program and indicates SD in the gear indicator in the speedometer.

- ▷ Press briefly:
CVT shifts from the Sport program to the manual mode
- ▷ Press selector lever briefly towards "+":
Transmission shifts upwards
- ▷ Press selector lever briefly towards "-":
Transmission shifts back.

1 to 6 appear in the gear indicator.

The transmission will only execute upshifts and downshifts that will result in a plausible combination of vehicle speed and engine rpm, for instance, downshifts that would result in excessive engine speed are not executed.

Switching from M/S + – into the selector lever positions P, R and N and switching from manual mode back into the Sport program is only possible via D.

CONTINUOUSLY VARIABLE AUTOMATIC TRANSMISSION (CVT)*



 Do not work in the engine compartment when a drive gear (forward or reverse) is engaged. If you do this, the vehicle could move. ◀

 Jump-starting and towing, refer to pages 113, 115. ◀

Available displays

P R N D S D 1 2 3 4 5 6 EP

Electronic transmission control module

If there is a malfunction in the transmission system, EP appears in the display.

All selector lever positions can still be selected. In positions for driving forward: The vehicle can now only be driven with a limited gear selection.

 Avoid high engine loads. Proceed to the nearest MINI center. ◀

PARKING LAMPS/LOW BEAMS

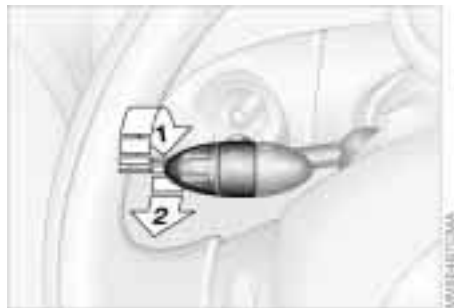

Switching on the parking lamps

Turn to the first position.

The front, rear and side vehicle lighting is switched on.

One-sided standing lamps, see next column.

Switching on the low beams

Turn to the second position.

With the low beams on and with the ignition switched off, only the parking lamps will remain on.

"Follow me home" lamps

If you switch off the engine with the low beams on, and then switch off the low beams, they remain lit for approx. one minute.



You can also have this function activated. ◀

Switching on the standing lamps

For parking, you can activate lights on one side of the vehicle (observe local laws).

In ignition key position 0:

Move the lever into the relevant turn signal indicator position.

"Lights on" warning

If the lights have not been switched off and the ignition key is in position 0, an acoustic signal sounds for a few seconds when you open the driver's door to remind you that the lights have not been switched off.

Daytime driving lamps*

If you desire, the light switch can be left in the second position:

When the ignition is switched off, the external lighting is also switched off.



You can have this function set by your MINI center. ◀

SIGNAL/HEADLAMP FLASHER

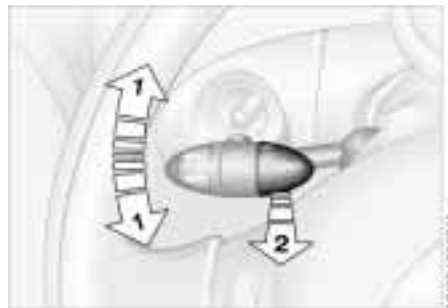

- 1 Turn signal indicator (green indicator accompanied by periodic clicking sound from the relay)
- 2 High beams/Headlamp flasher (blue indicator lamp)

To signal briefly

Press the lever up to but not beyond the detent.



If the indicator lamp of the indicators and the clicking from the relay are both faster than normal: one of the turn signal indicators has failed. ◀

INSTRUMENT LIGHTING



To control the instrument lighting, press the button.

To increase the illumination intensity

Keep the button pressed until the desired brightness is reached.

To decrease the illumination intensity

Press the button briefly.

With each brief press of the button, the illumination intensity is reduced in steps.

FOG LAMPS

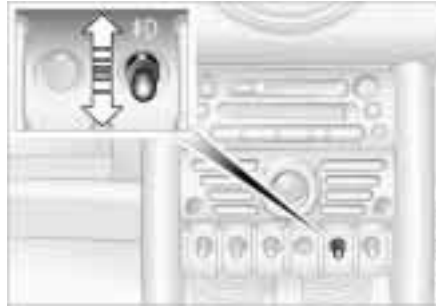

When the parking lamps/low beams are switched on:

Briefly press the switch upwards or downwards.

Briefly press once again to switch off.

Fog lamps*



Fog lamps switched on:

Green light-emitting diode in the switch lights up.

The fog lamps are deactivated whenever the high beams are switched on.

INTERIOR LAMPS

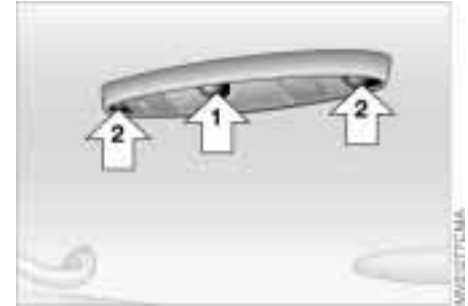

Switching the interior lamps on and off manually

Press button 1.

Switching the reading lamps on and off

Press button 2.

LIGHT-EMITTING DIODES

Light-emitting diodes (LEDs) installed behind translucent lenses serve as the light source for many of the controls and displays in your vehicle. These light-emitting diodes are related to conventional lasers, and legislation defines them as "light-emitting diodes, Class 1".

 Do not remove the protective lens and avoid staring directly at the unfiltered beam for several hours, as inflammation of the iris could result. ◀

WASHER/WIPER SYSTEM



- 0 Wipers parked
- 1 Intermittent operation or rain sensor
- 2 Normal wiper speed
- 3 Fast wiper speed
- 4 Brief wipe
- 5 Clean windshield and headlamps

Intermittent operation

(not on vehicles with rain sensor)

The interval varies depending on the speed being driven.

 You can have this function set by your MINI center. ◀

Rain sensor*

The rain sensor is located on the windshield, directly in front of the interior rear-view mirror. When the rain sensor is activated, the windshield wipers are automatically controlled depending on the amount of water (or snow) landing on the windshield.

To activate the rain sensor:

From ignition key position 1:

Lever in position 1.

The wipers move across the windshield once.

To deactivate the rain sensor:

Put lever in position 0.

 Switch the rain sensor off when passing through an automatic car wash. Failure to do so could result in damage caused by undesired wiper activation. ◀

Fast wiper speed

When the vehicle is stationary, the wipers switch automatically to normal wiper speed.

 You can have this function activated/deactivated by your MINI center. ◀

WASHER/WIPER SYSTEM

Cleaning windshield and headlamps*

The system sprays washer fluid against the windshield. The wipers are automatically activated for a brief period.

When the vehicle lighting is on, the headlamps are also cleaned at appropriate intervals.



Do not use the washers if there is any danger that the fluid will freeze on the windshield. If you do so, your vision could be obscured. For this reason, use an antifreeze agent, see page 89.

Do not use the washers when the reservoir is empty, since this could cause damage to the washing pump. ◀

Windshield washer jets*

The windshield washer jets are heated automatically when the ignition key is in position 2.

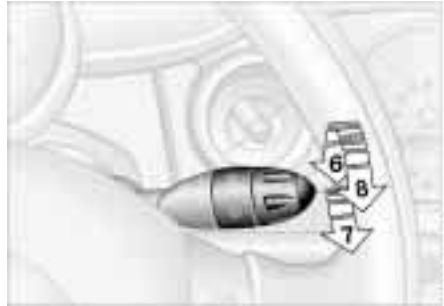

Rear window wiper

6 Intermittent operation:

Turn the cap to position 6

The rear window wiper moves across the window a number of times before switching to intermittent operation

Cleaning the rear window

7 Intermittent operation:

Turn the cap to position 7 and hold in place

8 In lever position 0:

Turn the cap to position 8 and hold in place

CRUISE CONTROL*

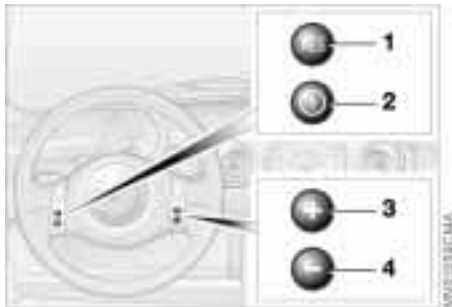

Starting at about 25 mph (40 km/h), the vehicle maintains and stores any vehicle speed that you specify.

 Do not use cruise control on twisting roads, when high traffic density prevents driving at a constant speed, when the road surface is slick (snow, rain, ice), or when the road surface is loose (rocks, sand). ◀

To activate the system

From ignition key position 1:

Press button 2.

The indicator lamp in the instrument cluster lights up.
Cruise control is active.

To maintain and store speed or to accelerate

Press button 3.

The system maintains and stores the current vehicle speed. Every time you tap the button, the speed increases by approx. 1 mph (2 km/h).

Press and hold button 3.

The vehicle accelerates without pressure on the accelerator pedal. When you release the button, the system maintains and stores the current speed.

 If, on a downhill gradient, the engine braking effect is not sufficient, the controlled speed may be exceeded. Speed can drop on uphill grades if the engine output is insufficient. ◀

To decelerate

Press button 4.

If you are already driving with active cruise control, the speed is decreased by approx. 1 mph (2 km/h) every time you briefly tap the button.

Press and hold button 4.

With the cruise control active, the system automatically reduces the throttle opening to slow the vehicle. When you release the button, the system maintains and stores the current speed.

CRUISE CONTROL*

To cancel the cruise control

When the system is activated, press button 2.

The indicator lamp stays lit.

You can use the cruise control again as required.

In addition, cruise control is canceled automatically

- ▷ if the brakes are applied
- ▷ when you apply pressure to the clutch pedal, or when you move the CVT selector lever from D to P, N or R
- ▷ or if the cruise speed is either exceeded or not met for an extended length of time (if you press the accelerator pedal and exceed the stored speed, for example).

To continue cruise control

Press button 1.

The vehicle accelerates to and maintains the last speed stored. If you turn the ignition key to position 0, the stored speed is deleted and the system is deactivated.

To deactivate the system

With cancelled cruise control, press button 2 once again.

The indicator lamp goes out and the stored speed is deleted.

ODOMETER



1 Trip odometer

To set to zero:

With ignition key in position 1, press the button until the trip odometer is at zero.

2 Odometer

You can activate the displays shown in the illustration with the ignition key in position 0 by pressing the button in the instrument cluster.

TACHOMETER



Do not operate the engine with the needle in the red overspeed zone of the gauge.

To protect the engine, the power is reduced when you approach a certain engine speed in this sector.

FUEL GAUGE



In the speedometer

Once indicator lamp 1 stays on continuously, there are still approx. 2.1 gallons (8 liters) of fuel in the fuel tank. Tank capacity: approx. 13.2 gallons (50 liters).

When you switch on the ignition, the indicator lamp lights up briefly to confirm that the system is operational.

If the tilt of the vehicle varies (when you are driving in mountainous areas, for example), the needle may fluctuate slightly.



Please refuel early, since driving to the last drop of fuel can result in damage to the engine and/or catalytic converter. ◀

FUEL GAUGE



In the navigation system

 Please also comply with the instructions in the previous column. ◀

Once indicator lamp 1 switches from orange to red, there are still approx. 2.1 gallons (8 liters) of fuel in the fuel tank.

TEMPERATURE GAUGE



Low temperature

The needle is located at the bottom or on the right.

The engine is still cold. Drive at moderate engine and vehicle speeds.

Center position

Normal operating temperature of the engine.

High temperature

As soon as there is a deviation from the center position upwards or to the left:

Drive moderately and at low engine speed, if necessary, switch off the engine and allow to cool down.

Checking coolant level, see page 91.

1 Red indicator lamp

When you switch on the ignition, warning lamp 1 comes on briefly to confirm that the system is operational.

If the lamp comes on while operating the vehicle, the engine has overheated. Switch off the engine immediately and allow it to cool down.

Navigation system option



Coolant temperature warning lamp in the tachometer.

If the lamp comes on while operating the vehicle, the engine has overheated. Switch off the engine immediately and allow it to cool down.

SERVICE INTERVAL DISPLAY



A flashing message and a "-" in front of the number mean that the service interval has already been exceeded by the distance shown on the display. Please contact your MINI center for an appointment.

For more information on the Service Interval Display, see page 93.



Remaining distance for service

The displays shown in the illustration appear for a few seconds when the ignition key is in position 1 or after the engine is started.

The next service due appears in miles (kilometers) with the message **INSPECTION** or/ and **OILSERVICE**, together with the distance remaining before the next scheduled service. The computer bases its calculations of the remaining distance on your driving style in the period immediately preceding your data request.

Brake fluid change

You can obtain a display of the number of days remaining until the next due brake fluid change, see page 92.

While the next due service is displayed, press the button in the display element.

As of the due date of the brake fluid change, the clock symbol also lights up in the remaining distance display for Service, see left column. Please contact your MINI center for an appointment.



Periods of immobilization in which the battery is disconnected are not taken into account by the display. For this reason, ensure that the brake fluid, independent of the display, is replaced every two years at the latest, see page 92. ◀

CLOCK



Settings

From ignition key position 1:

Left button: hours

Right button: minutes

Move forward in increments:

Press the button

or

Fast forward:

Press and hold the button

Changeover from 24-hour to 12-hour mode:

Press both buttons at the same time for approx. 5 seconds.

COMPUTER*

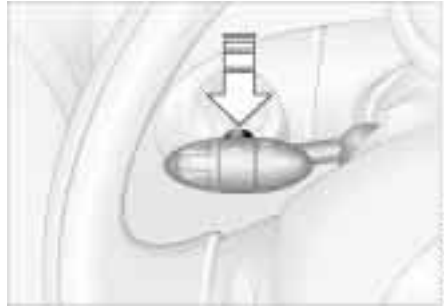

Mode selection

With the ignition key in position 1 and higher, you can use the button in the turn signal indicator lever to retrieve information from the computer for display in the tachometer. By pressing the button briefly, you can call up a new function for display.

The displays appear in the following order: Outside temperature, cruising range, average fuel consumption, average vehicle speed.

Starting with ignition key position 1, the last active setting is displayed.

 If the vehicle is equipped with a navigation system, see chapter covering the computer in the navigation system Owner's Manual. ◀

COMPUTER*



Average speed – Average fuel consumption

Press the button in the turn signal indicator lever for a longer period.

The average speed value/consumption value on display is recalculated.

Any time spent when the vehicle is stationary and the engine is switched off is ignored for the calculation.

Outside temperature

If the vehicle is equipped with a tachometer, but not with a computer, the temperature is always displayed.



You can display the exterior temperature and distance driven in other units of measurement. ◀

Cruising range

The computer bases its calculations for the cruising range on the driving style and on the remaining fuel in the tank.

AUTOMATIC STABILITY CONTROL PLUS TRACTION (ASC+T) *

The concept

This system optimizes vehicle stability and traction, especially when just starting off, when accelerating or when cornering. ASC+T recognizes the danger present in traction loss and will increase driving stability and traction by reducing the engine's output, and if necessary, by applying the brakes to the front wheels. ASC+T is operational each time you start the engine.

 The laws of physics cannot be repealed, even with ASC+T. An appropriate driving style always remains the responsibility of the driver. Avoid using the additional safety margin provided by the system as an excuse for taking unnecessary risks. Do not make any modifications to the ASC+T system. Allow only authorized technicians to perform service procedures on the ASC+T. ◀

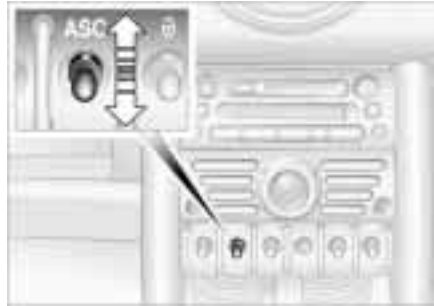

Switch off the ASC+T

Briefly press the switch.

The indicator lamp stays lit.

When driving with snow chains or to "rock free" in snow, it can be helpful to switch off the ASC+T for a brief period.

 To maintain vehicle stability, always drive with the ASC+T switched on whenever possible. ◀

Switch the ASC+T back on

Briefly press the switch once again.

Indicator lamp goes out.

Indicator lamp



The indicator lamp on the instrument cluster will go out shortly after the ignition has been switched on, see pages 16, 17.

If the indicator lamp flashes: ASC+T controls the drive and braking forces.



If the indicator lamp fails to go out after the engine is started, or if it comes on during normal driving and stays on:

If the system is either defective or was switched off with the button, then the stabilizing applications described are no longer available. You can, however, drive the vehicle normally without ASC+T. In the event of a malfunction, please see your MINI center, see pages 16, 17. ◀

DYNAMIC STABILITY CONTROL (DSC)*

The concept

This system maintains driving stability even in critical driving situations.

The system optimizes vehicle stability during acceleration and when starting from a full stop, as well as optimizing traction. In addition, it recognizes unstable vehicle conditions, such as under- or oversteering, and, as far as is possible within the laws of physics, helps keeping the vehicle on a steady course by reducing the rpms and brake applications to the individual wheels.

The DSC is operational every time you start the engine. DSC contains the functions Antilock Brake System ABS/Electronic Brake Force Distribution EBV/ASC+T.

 The laws of physics cannot be repealed, even with DSC. An appropriate driving style always remains the responsibility of the driver. We therefore urge you to avoid using the additional safety margin of the system as an excuse for taking risks.

Do not make any modifications to the DSC system. Allow only authorized technicians to perform service procedures on the DSC. ◀

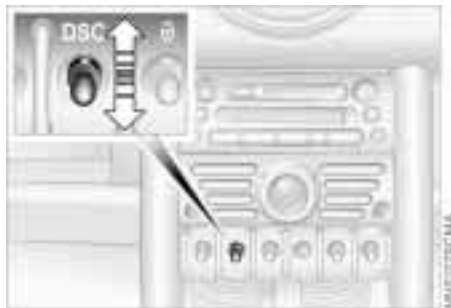

To switch off the DSC

Briefly press the switch.

The indicator lamp stays lit.

When driving with snow chains, it may be effective to switch off the DSC for a brief period.

 To maintain stability, always drive with the DSC switched on whenever possible. ◀

To switch DSC back on

Briefly press the switch once again.

Indicator lamp goes out.

Indicator lamp



The indicator lamp on the instrument cluster will go out shortly after the ignition has been switched on, see pages 16, 17.

If the indicator lamp flashes:
DSC controls the drive and braking forces.



If the indicator lamp fails to go out after the engine is started, or if it comes on during normal driving and stays on:

If the system is either defective or was switched off with the button, then the stabilizing applications described are no longer available. The vehicle will remain completely operational, however, without DSC.

In the event of a malfunction, please see your MINI center, see pages 16, 17. ◀

FLAT TIRE MONITOR

The concept

The tire inflation pressure is determined from the signals of the ABS sensors. The system provides an alert whenever the tire inflation pressure drops below the pressure in any other tire.

Requirement

So that the system can "familiarize" itself with the correct inflation pressure, please do the following:

1. Check the tire inflation pressure in all tires
2. Compare them with the inflation pressure table, see page 81, and adjust the pressures if necessary
3. Initialize the system.

 Check the tire inflation pressure regularly and correct it if necessary, see page 80. ◀

Flat tire



The indicator lamp in the instrument cluster informs you by flashing when the tire inflation pressure of a tire drops in relation to any other tire. In addition, an acoustic signal is sounded.

- ▷ Vehicles with safety (run-flat) tires, see notes on pages 110, 80, 84
- ▷ Vehicles with normal tires, see notes on pages 106, 80.



The Flat Tire Monitor cannot alert you to severe and sudden tire damage caused by external factors. Another factor which the Flat Tire Monitor does not recognize is the balanced and very gradual pressure loss that takes place in all tires over an extended period of time. ◀

Malfunctions

As long as there is still a malfunction, the yellow indicator lamp on the instrument cluster will stay lit up.

The indicator lamp also lights up in the event of a system malfunction.

Please contact your MINI center in these cases.



Initializing the system

Only initialize the system if the inflation pressure, e. g. after a tire change, has been corrected.

1. Ignition key in position 2
2. Press the button long enough for the yellow indicator lamp in the instrument cluster to light up for a few seconds
3. Start the engine.

After a few minutes driving time, the Flat Tire Monitor sets the current inflation pressure in the tires as the target values to be monitored.

FLAT TIRE MONITOR

 Do not initialize the system when snow chains are fitted. When driving with snow chains, false alarms can occur or pressure losses might not be detected. ◀

 In the following situations false alarms can also occur under certain circumstances or the detection of inflation pressure loss can be delayed:

- ▷ When driving on roads covered with snow or on other slippery road surfaces
- ▷ A sporty driving style (slip at the driven wheels, high lateral accelerations). ◀

PARK DISTANCE CONTROL (PDC)*

The concept

The PDC assists you when you back into a parking space. A signal warns you of the distance to an obstacle. To do this, four ultrasonic sensors in the rear bumper measure the distance to the nearest object. The range for the sensors located at both rear corners ends approx. 2 ft (60 cm) behind the bumpers. The range for the two middle sensors is slightly less than 5 ft (1.5 meters).

The system starts to operate automatically about one second after you select reverse with the ignition key in position 2. PDC is deactivated when you shift back out of reverse.

Acoustical signals

The distance to the nearest object is indicated by a tone sounding at various intervals. As the distance between vehicle and object decreases, the intervals between the tones become shorter. A continuous tone indicates the presence of an object less than 9 in (20 cm) away.

The warning signal is canceled after approx. three seconds if the distance to the obstacle remains constant during this time (if you are moving parallel to a wall, for instance).

System malfunctions will be indicated by a continuous high-pitched tone when the system is activated the first time. Please have your MINI center resolve the problem.

 Even with PDC, final responsibility for estimating the distance between the vehicle and any obstructions always remains with the driver. Even when sensors are involved, there is a blind spot in which objects cannot be detected. Moreover, the detection of obstructions can approach the physical limits of ultrasonic measurement, as occurs e. g. in the case of thin and wedge-shaped objects. Certain sources of sound, such as a loud radio, could drown out the PDC signal tone. ◀

 Keep the sensors clean and free of ice or snow in order to ensure that they will continue to operate effectively. Do not apply high pressure spray to the sensors for a prolonged period of time. Always maintain a distance of more than 4 in (10 cm). ◀

AIR CONDITIONER SYSTEM

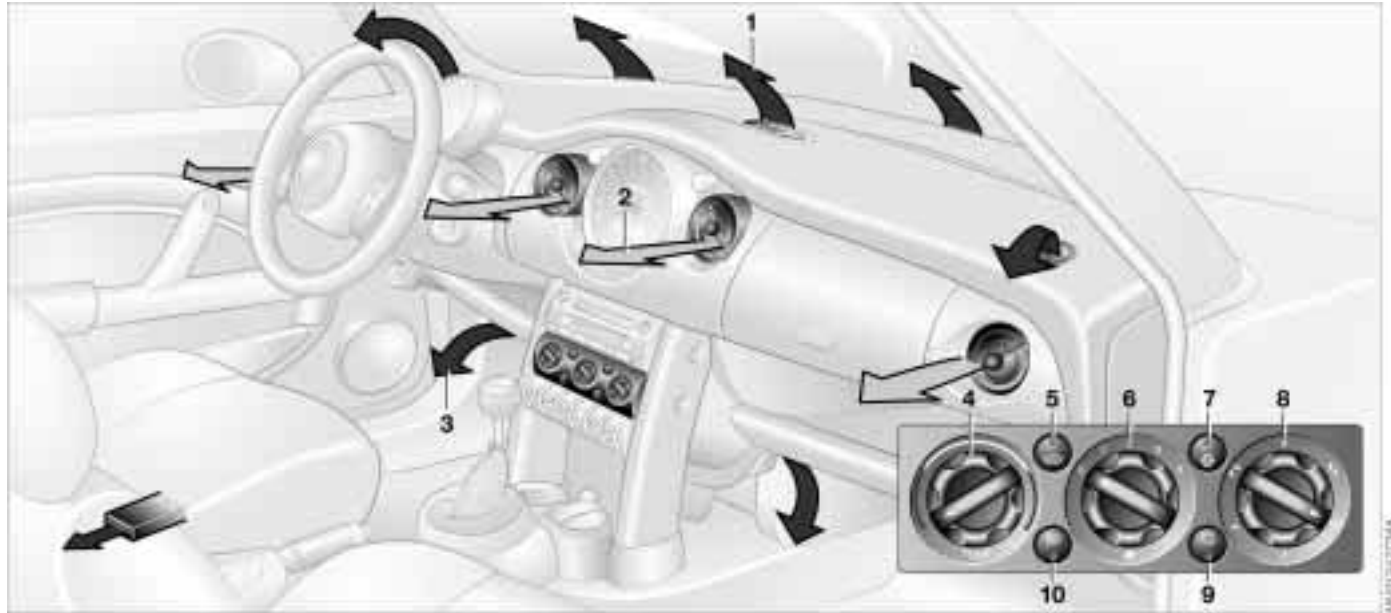

1 Air onto the windshield and onto the side windows

2 Air for the upper body area 66

3 Air for the front and rear footwells

4 Temperature 65

5 Windshield heating 65

6 Blower for air supply 65

7 Air conditioner 65

8 Air distribution

9 Recirculated-air mode 65

10 Rear window defroster 65

AIR CONDITIONER SYSTEM

Air supply



You can select blower speeds from 1 to 4. Position 0: blower is switched off. The button for recirculated-air mode fully blocks the supply of air from outside.

Heating and ventilation operate as of position 1.

Temperature



Turn to the right (red) to increase the temperature of the passenger compartment.

Rapid heating: turn to the extreme right. Then select a pleasant interior temperature.

Air distribution



Air distribution in upper body region ➔, upper body region and footwell ⬇️➔, footwell ⬇️, footwell and windows ⬆️ and

windows 🌬️.

All intermediate positions are possible, see illustration and overview on page 64.

Rear window defroster



Rear window defroster switched on:
Indicator lamp lights up.

As long as the indicator lamp is lit, the heating operates at high power output (rapid defrosting).

Indicator lamp goes out.

The heating continues to run with reduced power output and then switches itself off automatically.

Windshield heating*



Windshield heating switched on:
Indicator lamp lights up.

As long as the indicator lamp is lit, the heating operates at high power output (rapid defrosting).

Indicator lamp goes out.

The heating continues to run with reduced power output and then switches itself off automatically.

Air conditioner



Air conditioner operation switched on:
Indicator lamp lights up.

The air is cooled and dehumidified and – depending on the temperature setting – rewarmed.

After the engine start, the windshield can fog over briefly.



Condensation forms in the air conditioner system during operation, and then exits under the vehicle. Traces of condensed water under the vehicle are therefore normal. ◀

Recirculated-air mode



Supply of outside air into the vehicle is blocked: indicator lamp lights up.

The air within the vehicle is recirculated.



Do not run the recirculated-air mode for longer than approx. 30 minutes, as otherwise the air quality in the interior will deteriorate. ◀



If the windows fog over in the recirculated-air mode, switch the recirculated-air mode off and increase the air supply as required. ◀

AIR CONDITIONER SYSTEM

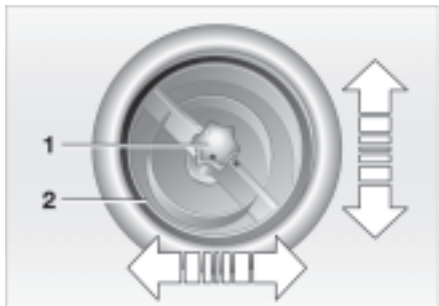

Microfilter

The microfilter removes dust and pollen from the incoming air.

Your MINI center will replace it during routine maintenance. A substantial reduction in the air supply indicates that the filter must be replaced before scheduled maintenance.



Draft-free ventilation

Air supply for the upper body area:

Button 1: open and close the vent outlets as required by turning.

The points indicate the position in each case.

Vent 2: change the direction of the airflow by swiveling.

Defrosting and demisting the windshield and side windows

1. Set the rotary blower speed control for the airflow rate to position 4
2. Turn the rotary temperature control completely to the right (red)
3. Rotary control for air distribution in position 
4. To defrost the rear window: switch on the rear window defroster and, if required, the windshield heating.

AUTOMATIC CLIMATE CONTROL*

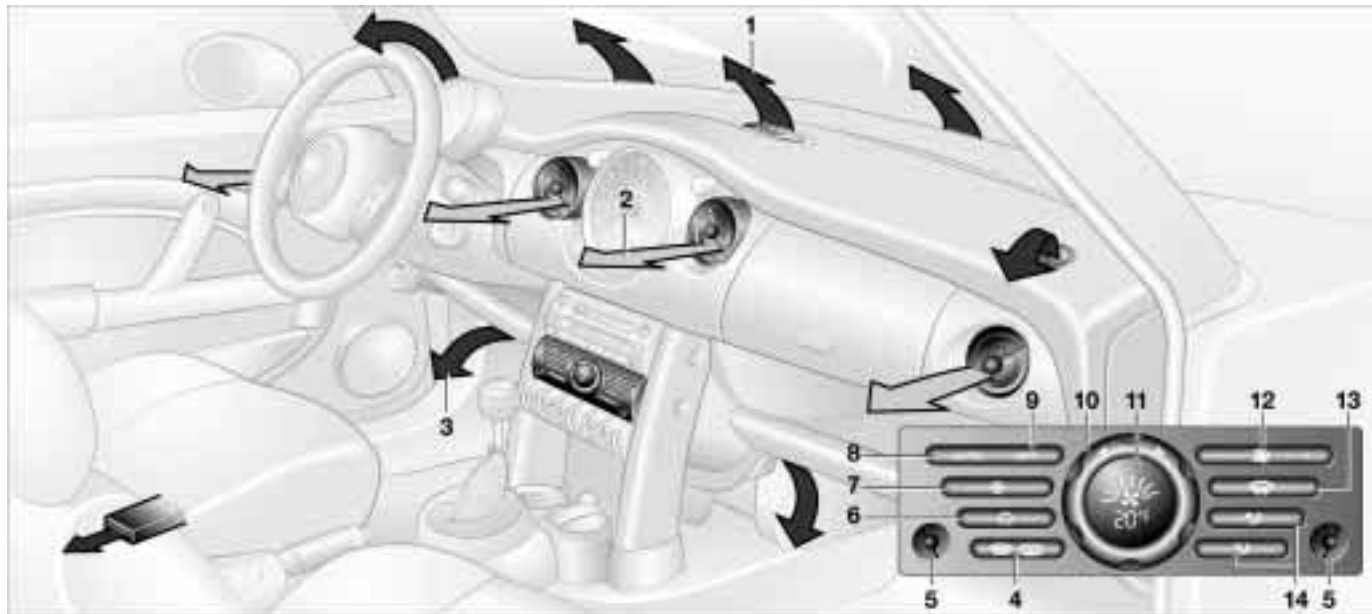

1 Air onto the windshield and onto the side windows

2 Air for the upper body area, see page 69

3 Air for the front and rear footwells

4 Rear window and windshield heating 68

5 Interior temperature sensor – please keep clear and unobstructed

6 Recirculated-air mode 68

7 Air conditioner 68

8 Automatic air distribution and supply 68

9 Switching the automatic climate control on/off 68

10 Temperature 68

11 Display for temperature and air supply 68

12 Blower for air supply 69

13 Defrosting and demisting the windshield and side windows 69

14 Individual air distribution 69

AUTOMATIC CLIMATE CONTROL*

Automatic air distribution and supply

 Automatic program (AUTO):
Indicator lamp lights up.

Automatic adjustment of the air distribution and the air supply and adaptation of the specified temperatures to external influences (outside temperature and sunlight).

In the automatic program (AUTO), the air conditioner is activated automatically.

Switching the automatic climate control on/off

 The blower, heating and air conditioner are switched off.

To switch the automatic climate control on again:
Press any button of the automatic climate control.

Air conditioner

 Air conditioner switched on:
Indicator lamp lights up.

The air is cooled and dehumidified and – depending on the temperature setting – rewarmed.

In the automatic program (AUTO), the air conditioner is activated automatically.

After the engine start, the windshield can fog over briefly. Switching on the air conditioner reduces condensation on the windows.

 Condensation forms in the air conditioner system during operation, and then exits under the vehicle. Traces of condensed water under the vehicle are therefore normal. ◀

Recirculated-air mode

 Supply of outside air into the vehicle is blocked:

Indicator lamp lights up.
The air within the vehicle is recirculated.
In the automatic program (AUTO) in hot weather conditions, the recirculated-air mode is activated temporarily to enable faster cooling.

 Do not run the recirculated-air mode for longer than approx. 30 minutes, as otherwise the air quality in the interior will deteriorate. ◀

 If the windows fog over in the recirculated-air mode, switch the recirculated-air mode off and increase the air supply as required. ◀

Rear window defroster and windshield heating*

 Rear window defroster and windshield heating switched on:
Indicator lamp lights up.

As long as the indicator lamp is lit, the heating operates at high power output (rapid defrosting).

Indicator lamp goes out.
The heating continues to run with reduced power output and then switches itself off automatically.

Temperature



Setting the temperature:
Move or turn the wheel in the appropriate direction to increase the temperature step by step.

The figures in the display provide a general indication of interior temperature. When you start the vehicle, the system ensures that the selected temperature is achieved as quickly as possible and then maintained.



Permanent heating with maximum power output at temperature selection "HI". Permanent cooling at "LO". ◀

AUTOMATIC CLIMATE CONTROL*

Air supply



Press the left or right half of the button: the air supply varies.

Defrosting and demisting the windshield and side windows



Press the button briefly. The indicator lamp flashes.

Ice and condensation are removed from the rear window/windshield and side windows.

The rear window defroster/windshield heating is switched on automatically. It can be switched off again separately.

Press the button for a longer period. Only air to the windshield.

Individual air distribution



Combine the air distribution yourself. This switches off the automatic program.

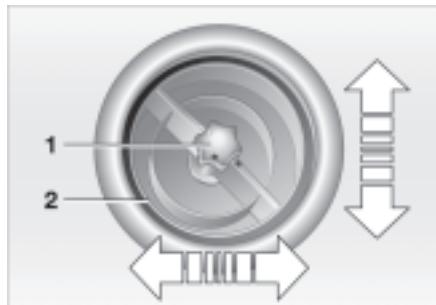

Draft-free ventilation

Air supply for the upper body area:

Button 1: open and close the vent outlets as required by turning.

The points indicate the position in each case.

Vent 2: change the direction of the airflow by swiveling.

Microfilter/activated-charcoal filter

The microfilter removes dust and pollen from the incoming air. The activated-charcoal filter provides additional protection by filtering gaseous pollutants from the outside air.

Your MINI center replaces this combined filter as a standard part of your scheduled maintenance. A substantial reduction in the air supply indicates that the filter must be replaced before scheduled maintenance.

GLOVE COMPARTMENT

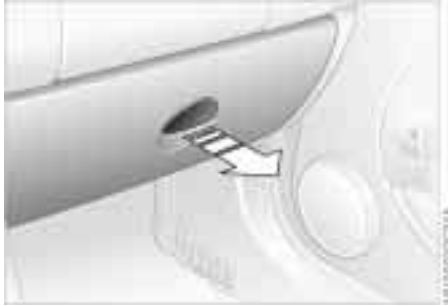

To open:
Pull the handle.
The light goes on.

To close:
Fold the door up.

 To prevent injury in the event of an accident, close the glove compartment immediately after use. ◀

ASHTRAY/BEVERAGE HOLDER CIGARETTE LIGHTER



Ashtray

The ashtray is located in one of the beverage holders in the center console. In the rear, an ashtray can also be fitted in the beverage holder at the end of the center console.

Beverage holders

There are two beverage holders at the front of the center console. Another is located at the end of the center console.



From ignition key position 1:
Press the cigarette lighter in.
Remove as soon as the lighter jumps back out.

 Hold or touch the hot cigarette lighter by the knob only. Holding or touching it in other areas could result in burns. ◀

Lighter socket

Suitable for attaching power supplies for flashlights, car vacuum cleaners, etc., up to a rating of approx. 200 Watts at 12 Volts. Avoid damaging the socket with plugs of different shapes or sizes.

LUGGAGE COMPARTMENT COVER

When the tailgate is opened, the luggage compartment cover is also raised.

 Never place heavy or hard objects on the luggage compartment cover, as otherwise occupants could be injured during braking maneuvers. ◀

 The warning triangle* is located beneath the luggage compartment cover, see page 113.

Comply with legal requirements requiring you to carry a hazard warning triangle in the vehicle. ◀



Removal

To load bulky luggage, the compartment cover can be removed.

1. Remove the retaining straps on the tailgate
2. Pull the luggage compartment cover out towards the rear.

FOLDABLE REAR BACKREST



Unlock and fold

1. Pull lever
2. Fold the rear backrest forwards.

 When folding the backrest back into its original position always ensure that the detent engages securely. A loose backrest might fail to prevent cargo from entering the passenger compartment during sudden braking or evasive maneuvers, posing a potential hazard to occupants. ◀

LOADING CARGO

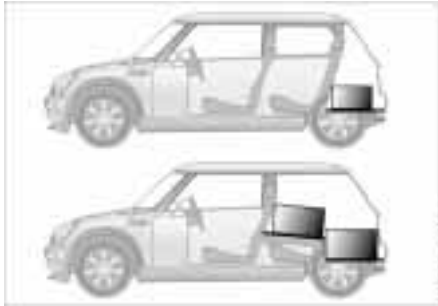

Stowing cargo

- ▷ Load heavy cargo as far forward as possible – directly behind the backrests – and as low as possible
- ▷ Cover sharp edges and corners
- ▷ Do not pile objects higher than the top edge of the backrest

- ▷ For very heavy loads when the rear seat is not occupied, secure each safety belt in the opposite buckle. This provides additional stabilization for the rear backrests.



Securing the load

- ▷ For small, light items, secure using the luggage compartment net* or elastic straps
- ▷ For large, heavy items, see your MINI center for load-securing devices*. Lashing eyes are provided at the inner corners of the luggage compartment for attaching these load-securing devices
- ▷ Comply with the information enclosed with the load-securing devices.

LOADING CARGO

 Always position and secure the load carefully. If you do not, it can endanger the passengers during braking or evasive maneuvers. Do not exceed the permissible gross weight and axle load, see page 122, otherwise the vehicle's operating safety is no longer assured and you are in violation of the law. Do not stow heavy or hard objects in the passenger compartment without first securing them. Otherwise they would be thrown around during braking and evasive maneuvers and endanger the occupants. ◀

ROOF-MOUNTED LUGGAGE RACK*

-  When loading a roof-mounted luggage rack, ensure that there is sufficient space for the movement of the sliding/tilt sunroof and that no objects protrude into the swiveling area of the tailgate, as otherwise damage can occur. ◀
-  Do not secure the roof-mounted luggage rack to the trim panels/strips: the lack of a secure hold could lead to damage or accidents. ◀
-  Special roof-mounted luggage racks for your MINI are available as accessories from your MINI center. ◀



OVERVIEW

OVERVIEW

CONTROLS

CONTROLS

OPERATION, CARE, MAINTENANCE

OPERATION

OWNER SERVICE PROCEDURES

REPAIRS

TECHNICAL DATA

DATA

INDEX

INDEX

BREAK-IN PROCEDURES

To ensure that your vehicle provides maximum economy throughout a long service life, we request that you comply with the following information:

Engine

Up to 1,200 miles (2,000 km):

Attempt to constantly vary both vehicle and engine speed during these initial miles while remembering to avoid engine speeds in excess of 4,500 rpm and/or vehicle speeds of over 95 mph (150 km/h).

Absolutely avoid using the full-throttle or kickdown position for the accelerator.

Once you have driven 1,200 miles (2,000 km), both the engine and vehicle speed can be gradually increased.

You should also comply with these break-in procedures if the engine has to be replaced at a later point.

Tires

Due to technical factors associated with their manufacture, tires do not achieve their full traction potential until after an initial break-in period. We therefore ask you to drive with extra care during the first 200 miles (300 km).

Brake system

Approx. 300 miles (500 km) must be driven before the brake pads and rotors achieve the optimum pad-surface and wear patterns required for trouble-free operation and an extended service life.

Clutch

Roughly 300 miles (500 km) must be driven before the clutch starts to operate at optimum efficiency. Remember to engage the clutch carefully during this initial period.

GENERAL DRIVING NOTES

Parking the vehicle

Condensation forms in the air conditioner system during operation, and then exits under the vehicle. Traces of condensed water under the vehicle are therefore normal.

Brakes

 Do not rest your foot on the brake pedal while driving. Even light but consistent pedal pressure can lead to high temperatures, brake wear and possibly even brake failure. ◀

Hydroplaning

 When driving on wet or slushy roads, reduce road speed. If you do not, a wedge of water can form between tires and road surface. This phenomenon is characterized by a partial or complete loss of contact between the tires and the road surface. The ultimate results are loss of steering and braking control. ◀

GENERAL DRIVING NOTES

Driving through water

 Do not drive through water on the road if it is deeper than 1 ft (30 cm), and then only at walking speed at the most. Otherwise, the vehicle's engine, the electrical systems and the transmission may be damaged. ◀

Clothes hooks

 When suspending clothing from the hooks, ensure that they will not obstruct the driver's vision. Do not hang heavy objects on the hooks. If you do so, they could cause personal injury during braking or evasive maneuvers. ◀

High temperatures

 High temperatures occur in any vehicle equipped with a catalytic converter. Do not remove the heat protection plates fitted in the area of the exhaust system and do not apply body-cavity protectant to this area. When driving, standing at idle or when parking, take precautions to avoid contact between the hot exhaust system and easily flammable materials (grass, hay or leaves, for example). Such contact could lead to a fire, resulting in serious personal injury and property damage. ◀

REFUELING



 Always switch off the engine before refueling. If you do not, fuel cannot be filled into the tank and the "Service Engine Soon" lamp may come on. ◀

1. Open the fuel filler door
2. Turn the filler cap counterclockwise
3. Put the filler cap in the bracket attached to the fuel filler door.

 Always observe all applicable precautions and regulations when handling fuels. Never carry spare fuel containers in your vehicle. Whether empty or full, these containers can leak, cause an explosion, and lead to fire in the event of a collision. ◀

Simple and environmentally friendly

 Always observe all safety precautions posted at the service station when handling fuel. ◀

When refueling, insert the filler nozzle completely into the filler pipe. Pulling the nozzle out of the pipe during refueling

- ▷ results in premature pump shutoff
- ▷ and will reduce the effect of the fuel vapor recovery system on the pump.

As long as the filler nozzle is used properly, the fuel tank is full whenever the nozzle shuts off the first time.

Tank capacity: approx. 13.2 gallons (50 liters).

 Close the fuel cap carefully after refuelling until a "click" is heard. While closing, be sure not to squeeze the strap which is fastened to the filler cap. A loose or missing cap will activate the "Service Engine Soon" warning lamp. ◀

 Refill early to avoid damaging the catalytic converter; never attempt to drive to the last drop of fuel in the tank. ◀

FUEL SPECIFICATIONS

The engine uses lead-free gasoline only.

Required fuel:

▷ Premium Unleaded Gasoline,
min. 91 AKI.
AKI = Anti Knock Index.



Do not use leaded fuels. The use of leaded fuels will cause permanent damage to the emissions-control system's oxygen sensor and the catalytic converter. ◀

ANTILOCK BRAKE SYSTEM (ABS)

The concept

The ABS keeps the wheels from locking while braking, thereby enhancing active driving safety.

ABS also includes Electronic Brake Force Distribution (EBV).

Braking with ABS

To achieve optimal performance from ABS when reacting to critical situations you should apply maximum pressure to the brake pedal ("panic stop").

Since the vehicle maintains steering responsiveness, you can nevertheless avoid possible obstacles with a minimum of steering effort.

Pulsation of the brake pedal in conjunction with the sound of hydraulic regulation indicates to you that you are driving at the limit and reminds you to readapt your vehicle's speed to road surface conditions.

BRAKE SYSTEM

Brake fluid level

If the brake fluid level is too low and brake pedal travel has become longer, there may be a defect in one of the brake system's hydraulic circuits.



Proceed to the nearest MINI center. Higher brake application pressure may be necessary under these conditions, there may be slight "pull" to one side, and brake pedal travel may be longer. Please remember to adapt your driving style accordingly. ◀

Disc brakes

When the vehicle is driven only occasionally, during extended periods when the vehicle is not used at all, and in operating conditions where brake applications are less frequent, there is an increased tendency for corrosion of the brake rotors and accumulation of contamination on the brake pads. This occurs because the minimal pressure that must be exerted by the pads to clean the rotors by brake applications is not reached.

Corrosion on brake rotors is signaled by a running or pulsation during braking; even extended subsequent braking will not cure this phenomenon.

It is a good idea to periodically dry the brakes with a gentle application when driving in rain and on wet roads. Monitor traffic conditions to ensure that this maneuver does not endanger other road users. The heat generated in this process helps dry the brake pads and rotors to ensure that your brake system will respond with undiminished efficiency when you need it.

Extended or steep mountain descents should be driven in the gear or in the driving position in which only minimal periodic brake application is required. This helps avoid placing excessive loads on the brake system. Stay within the allowable speed range, refer to page 55.



Do not coast with the clutch pressed or with the transmission or selector lever in Neutral. Do not coast with the engine switched off. The engine provides no braking effect when the transmission is in neutral and there is no power-assist for braking when the engine is switched off. ◀

Brake pads



For your own safety: use only brake pads that the manufacturer has released for your particular vehicle model. The manufacturer cannot evaluate non-approved brake pads to determine if they are suited for use, and therefore cannot ensure the operating safety of the vehicle if they are installed. ◀

TIRE INFLATION PRESSURE

Information for your safety

The factory-approved radial tires are matched to the vehicle and have been selected to provide optimum safety and driving comfort if used properly.

It is not merely the tire's service life, but also driving comfort and – above all else – driving safety that depend on the condition of the tires and the maintenance of the specified tire pressure.

Incorrect inflation pressure is a frequent cause of tire damage. It also significantly influences the roadholding ability of your MINI.

 Check tire inflation pressures regularly – at least every two weeks and before beginning a longer trip. Failure to observe these precautions can result in incorrect tire pressures, which cause instable handling response as well as tire damage, and can ultimately lead to an accident. Also check the inflation pressure on the space-saver spare tire. ◀

Comply with tire approval specifications

The specified pressures apply to the tire brands recommended by the manufacturer, which your MINI center can provide for you.



Inflation pressures are on a sticker attached to the B-pillar and visible with the driver's door open.

Checking tire inflation pressures

All pressures are specified in the standard units of pressure for your country (bar, psi, kilopascal), and apply to cold tires (tires at ambient temperature).

Vehicles with Flat Tire Monitor:
After correcting the tire inflation pressure, reinitialize the Flat Tire Monitor, see page 62.

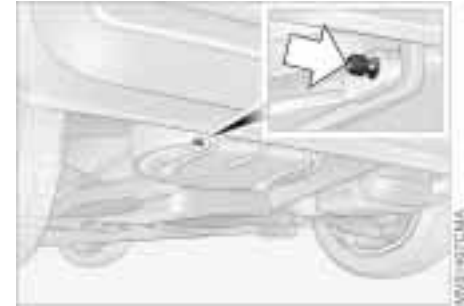

Checking the inflation pressure on the space-saver spare tire*

There is a valve extension accessible from the outside on the bumper for checking the inflation pressure.

Safety (run-flat) tires*

Safety tires are an optional extra consisting of self-contained tires and special rims. The tire reinforcement ensures that the tire retains residual safety in the event of pressure drop and driving remains possible to a restricted degree. The vehicle is equipped with a Flat Tire Monitor which indicates a flat-tire.

More information, see pages 62, 110.

TIRE INFLATION PRESSURE

Model	Tires Pressures specified in bar (kPa/psi)				
MINI COOPER	175/65 R 15	2.1 (210/30)	2.1 (210/30)	2.4 (240/35)	2.4 (240/35)
	195/55 R 16 205/45 R 17	2.1 (210/30)	2.1 (210/30)	2.4 (240/35)	2.4 (240/35)
	175/60 R 16 All winter tires	2.3 (230/33)	2.3 (230/33)	2.6 (260/38)	2.6 (260/38)
	Space-saver spare tire	4.2 (420/61)	4.2 (420/61)	4.2 (420/61)	4.2 (420/61)
MINI COOPER S	195/55 R 16	2.1 (210/30)	2.1 (210/30)	2.4 (240/35)	2.4 (240/35)
	205/45 R 17 195/55 R 16 M+S 205/45 R 17 M+S	2.3 (230/33)	2.3 (230/33)	2.6 (260/38)	2.6 (260/38)
	175/60 R 16 M+S	2.5 (250/36)	2.5 (250/36)	2.8 (280/41)	2.8 (280/41)

In the case of all-season tires, the tire inflation pressure for summer tires applies.

This data only applies to tires approved and/or recommended by the manufacturer, about which your MINI center will be glad to provide information.

TIRE CONDITION



Tire tread/tire damage

Inspect your tires frequently for tread wear, signs of damage and for foreign objects lodged in the tread. Check the tread depth.

The tread depth should not fall below 0.12 in (3 mm), although e. g. European legislation only prescribes a minimum tread depth of 0.063 in (1.6 mm). Below 0.12 in (3 mm) tread pattern depth, there is an increased risk of hydroplaning, even at relatively moderate speeds and with only small amounts of water on the road.

Wear indicators in the tread-groove base, see arrow, are spread around the circumference of the tire and are marked on the side wall of the tire with TWI – Tread Wear Indicator.

The indicators in the tread indicate at 0.063 in (1.6 mm) tread depth that the legally permitted wear limit has been reached.



Do not continue driving on depressurized (flat) tires, except with safety tires. A flat tire greatly impairs steering and braking response, and can lead to complete loss of control over the vehicle.

Avoid overloading the vehicle so that the permitted load on the tires is not exceeded. Overloading can lead to overheating and increases the rate at which damage develops inside the tires. The ultimate result can assume the form of a sudden air loss.

Unusual vibrations while driving, e. g. driving over a curb or similar, can indicate tire damage or other damage to the vehicle. This is also true for irregularities in the vehicle's handling characteristics, such as a pronounced tendency to pull to the left or right. Should this occur, respond by immediately reducing your speed. Proceed carefully to the nearest MINI center or professional tire center, or have the vehicle towed in to have its wheels and tires inspected.

Tire damage (up to and including blowouts) can endanger the lives of both the vehicle occupants and other road users. ◀

TIRE REPLACEMENT

To maintain good handling and vehicle response, use only tires of a single tread configuration from a single manufacturer. The manufacturer of your MINI tests and approves wheel and tire combinations.



Do not use retreaded tires, since driving safety may be impaired. This is due to the possible variations in casing structures and, in some cases, to their extreme age, which can lead to a decrease in their durability. ◀

DOT Quality Grades

Tread wear

Traction AA A B C

Temperature A B C



All passenger car tires must conform to Federal Safety Requirements in addition to these grades. ◀

Tread wear

The tread wear grade is a comparative rating based on the wear rate of the tire when tested under controlled conditions on a specified government test course.

For example, a tire graded 150 would wear one and one-half (1 ½) times as well on the government course as a tire graded 100.

The relative performance of tires depends upon the actual conditions of their use, however, and may depart significantly from the norm due to variations in driving habits, service practices and differences in road characteristics and climate.

Traction

The traction grades, from highest to lowest, are AA, A, B, and C.

Those grades represent the tire's ability to stop on wet pavement as measured under controlled conditions on specified government test surfaces of asphalt and concrete. A tire marked C may have poor traction performance.



The traction grade assigned to this tire is based on straight-ahead braking traction tests, and does not include acceleration, cornering, hydroplaning, or peak traction characteristics. ◀

Temperature

The temperature grades are A (the highest), B, and C, representing the tire's resistance to the generation of heat and its ability to dissipate heat when tested under controlled conditions on a specified indoor laboratory test wheel.

Sustained high temperature can cause the material of the tire to degenerate and reduce tire life, and excessive temperature can lead to a sudden flat tire. The grade C corresponds to a level of performance which all passenger car tires must meet under the Federal Motor Car Safety Standard No. 109. Grades B and A represent higher levels of performance on the laboratory test wheel than the minimum required by law.



The temperature grade for this tire is established for a tire that is properly inflated and not overloaded. Excessive speed, underinflation, or excessive loading, either separately or in combination, can cause heat buildup and possible tire failure. ◀

Uniform Tire Quality Grading

Quality grades can be found where applicable on the tire sidewall between tread shoulder and maximum section width. For example:

Tread wear 200

Traction AA

Temperature A

TIRE REPLACEMENT

Tire age

The date on which the tire was manufactured is indicated by the code on the sidewall:

DOT ... 1202 indicates that the tire was manufactured in Week 12 of the year 2002.

The manufacturer of your MINI recommends replacement of all tires – including the space-saver spare tire, after no more than 6 years.

Safety (run-flat) tires*

 For replacement, use only safety tires, as in the event of a flat tire there is no space-saver spare tire.

You will recognize safety tires by a circular symbol containing the letters RSC on the side of the tire, see pages 110, 80. ◀

WHEEL AND TIRE COMBINATIONS

The right choice

The factory-approved normal tires and safety tires are matched to the vehicle and have been selected to provide optimum driving safety and the desired driving comfort.

 Never mount wheels and tires that have not been specifically approved by the manufacturer for use on your particular model. Although other wheels and tires may theoretically have the same dimensions, variations in factors such as manufacturing tolerances can result in contact between tire and bodywork, ultimately leading to serious accidents. The manufacturer cannot evaluate non-approved wheels and tires to determine if they are suited for use, and therefore cannot ensure the operating safety of the vehicle if they are fitted. ◀

The manufacturer has tested certain tire brands in each size, categorized them as safe for use on the road, and approved them. Contact your MINI center for more details.



The correct wheel and tire combination affects various systems that would otherwise be impaired, e.g. ABS, ASC+T and DSC.

For this reason, use only tires of the same manufacture and tread configuration. In the event of a flat tire, for example, remount the approved wheel and tire combination as soon as possible. ◀

Storage

Store tires in a cool, dry place, protecting them against light whenever possible. Protect the tires against contact with oil, grease and fuel.

Tire changes between axles

Depending on individual operating conditions, different wear patterns appear on the front and rear axles. In the interests of safety and optimized handling characteristics, a change between the axles is not recommended.

WINTER TIRES

Choosing the right tire

The manufacturer recommends winter tires (M+S radial tires) for driving in adverse winter road conditions. While so-called all-season tires (M+S designation) provide better winter traction than summer tires with the load ratings S, T, H, V, W, they do not achieve the performance of winter tires.

In the interest of safe tracking and steering response, install winter tires made by the same manufacturer having the same tread configuration on all four wheels.

Before purchasing winter tires, check whether your MINI is fitted with safety tires. You will recognize safety tires by a circular symbol containing the letters RSC on the side of the tire, see page 110. In this case, use only safety tires, as in the event of a flat tire there is no space-saver spare tire.

Only winter tires recommended by the manufacturer of your MINI should be fitted. Any MINI center will be glad to advise you on the selection of the right winter tires for the relevant operating conditions.

Observing speeds

 Never exceed the maximum speed for which the tires are rated.

Unprofessional attempts by laymen to service tires can lead to damage and accidents.

Have this work performed by skilled professionals only. Your MINI center will be glad to assist you with both their expertise and the proper equipment for your vehicle. ◀

Tire condition, tire inflation pressure

 Once the tire wears to below 0.16 in (4 mm), winter tires display a perceptible decrease in their ability to cope with winter driving conditions, and should be replaced in the interest of safety. ◀

Comply with the specified tire inflation pressures and be sure to have the wheel and tire assemblies balanced every time you change the tires.

SNOW CHAINS*

 The use of narrow-link snow chains is permitted in pairs only and only on the front wheels with the following tires:

175/65 R 15

175/60 R 16

When fitting, comply with the manufacturer's instructions. ◀

 With chains, do not exceed a speed of 30 mph (50 km/h). ◀

 After fitting the snow chains, do not activate the Flat Tire Monitor.

When driving with snow chains, it can be helpful to switch off the ASC+T or DSC for a brief period, see pages 60, 61. ◀

HOOD

 Do not attempt to service your vehicle if you do not have the required technical background. Before working in the engine compartment, switch off the engine and allow it to cool down. Before working on the electrical system, always disconnect the battery first. For all work on the vehicle, comply with the appropriate information and instructions. Failure to work in an informed, professional manner when servicing components and materials constitutes a safety hazard for vehicle occupants and other road users. If you are not familiar with the guidelines, please have the operations performed by your MINI center. ◀

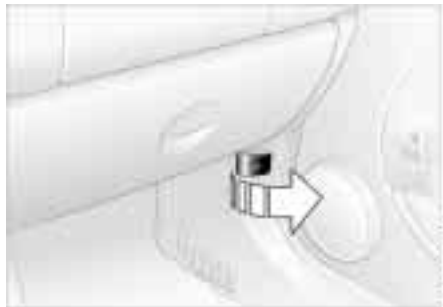

To unlock

Pull the lever in the right door area beneath the instrument panel.



To open

1. Reach under the hood
2. Pull the release lever
3. Open the hood.

To close

Allow the hood to fall from a height of about 12 in (30 cm).

 To avoid injuries, be sure that the travel path of the hood is clear when it is closed, as with all closing procedures. If it is determined that the hood is not completely closed while driving, stop immediately and close it securely, see also page 16. ◀

ENGINE COMPARTMENT – MINI COOPER

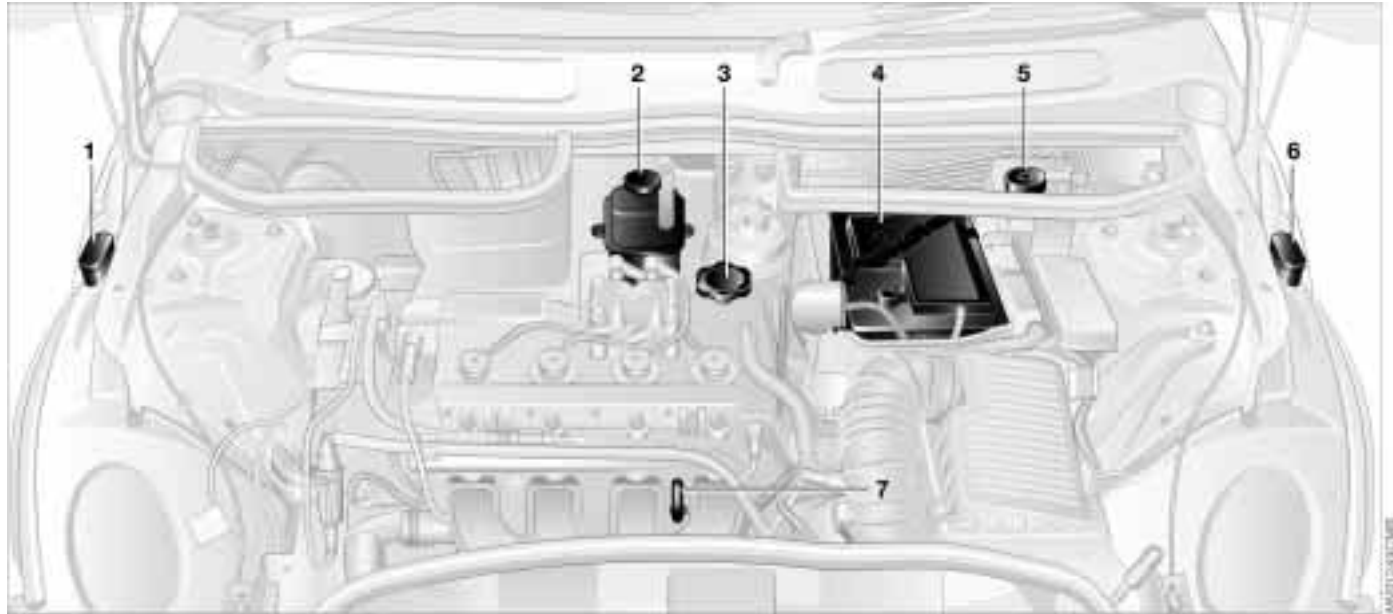

1 Reservoir for windshield washer system 89

2 Coolant expansion tank 91

3 Engine oil filler neck 90

4 Battery 111

5 Brake fluid reservoir 92

6 Reservoir for headlamp cleaning system 89

7 Engine oil dipstick 89

ENGINE COMPARTMENT – MINI COOPER S

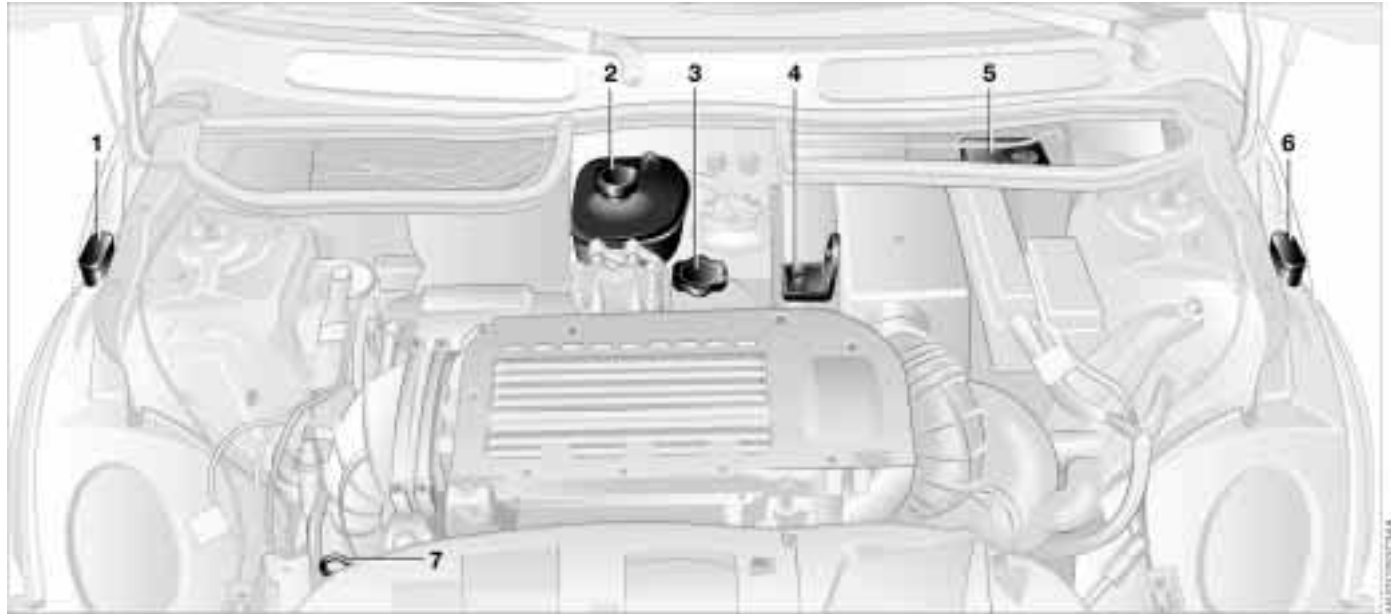

1 Reservoir for windshield washer system 89

2 Coolant expansion tank 91

3 Engine oil filler neck 90

4 Auxiliary terminal for jump-starting 113

5 Brake fluid reservoir 92

6 Reservoir for headlamp cleaning system 89

7 Engine oil dipstick 89

WASHER FLUID



Headlamp* and windshield washer system

Capacity approx. 2.6 quarts (2.5 liters) per reservoir.

Fill with water and – if required – with anti-freeze (according to manufacturer's recommendations).



We recommend that you mix the washer fluid before adding it to the reservoir. ◀



Antifreeze agent for the washer systems is flammable. Always keep it well away from sparks and open flames, and store it in tightly closed containers well out of the reach of children. Always observe the instructions for use provided on the container. ◀

ENGINE OIL

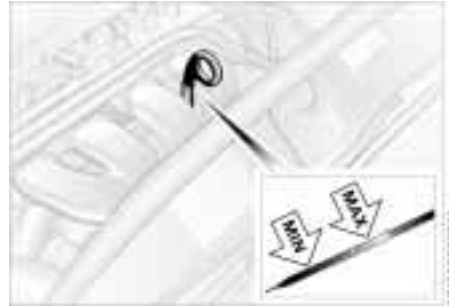

The oil volume between the two marks on the dipstick ("MIN", "MAX") corresponds to approx. 1.1 quarts (1 liter). Do not fill beyond the upper notch on the dipstick. Excess oil will damage the engine.

Measuring the oil level

1. Park the vehicle on a level surface
2. Switch off the warmed-up engine
3. Pull the dipstick out after approx. 5 minutes and wipe it off with a lint-free cloth, paper towel, or similar material
4. Carefully push the dipstick all the way into the guide tube and pull it out again.

The oil level must be between the two marks on the dipstick.

As with fuel economy, oil consumption is directly influenced by your driving style and vehicle operating conditions.

ENGINE OIL





Adding engine oil

Only top up oil when the oil level has dropped to just above the lower notch of the dipstick, but before it goes below this mark.

 MINI engines are designed to operate without oil additives; the use of additives could lead to damage in some cases. This also applies to the CVT, the manual transmission, and the differential. ◀

The manufacturer recommends that you have the oil changed only at your MINI center.

 Continuous exposure to used oil has caused cancer in laboratory testing. For this reason, any skin areas that come into contact with oil should be thoroughly washed with soap and water. Always store oil, grease, etc., out of reach of children. Comply with all warning labels and information on lubricant containers. ◀

 Comply with the applicable environmental laws regulating the disposal of used oil. ◀

Approved engine oils

The quality of the engine oil selected has critical significance for the operation and service life of an engine. Based on extensive testing, the manufacturer approves only certain grades of engine oil.

 You can find out from your MINI center which individual oils have been approved by the manufacturer. ◀

Alternative oil specifications

If you are unable to obtain one of these oils, you may use small volumes of other oils between oil changes in exceptional cases.

One of the following oil specifications must be on the oil package:

- ▷ Preferred: BMW Longlife-01
- ▷ Alternative: BMW Longlife-98, BMW Longlife or ACEA A3.

COOLANT

 Do not add coolant to the cooling system when the engine is hot.

Escaping coolant can cause burns.

To avoid the possibility of damage later on, never use anything other than factory-approved, nitrite and amino-free extended-duty antifreeze with corrosion inhibitor.

Every MINI center is aware of these.

Antifreeze and anti-corrosion agents are hazardous to health. Always store these agents in tightly-closed original containers kept well away from the reach of children.

Extended-duty antifreeze with corrosion inhibitor contains the flammable substance ethylene-glycol. For this reason, do not spill extended-duty antifreeze with corrosion inhibitor on hot engine parts. It could catch fire and cause serious burns. ◀

 Comply with the applicable environmental laws regulating the disposal of extended-duty antifreeze with corrosion inhibitor. ◀



The illustration shows an example of the coolant tank on the MINI COOPER.

Checking coolant level

Correct coolant level for cold engine (approx. 68 °F / 20 °C):

Up to the mark "MAX" of the transparent expansion tank.

 Only open the cap of the expansion tank when the engine has cooled down. The needle on the coolant temperature gauge in the instrument cluster must be no higher than in the first quarter, otherwise there is a danger of scalding. ◀

To add coolant

MINI COOPER:

1. Slowly open the cap by turning it with the tab to allow accumulated pressure to escape.
2. Pull open the cap completely.
3. If the coolant is low, slowly add coolant until the correct level is reached – do not overfill.

MINI COOPER S:

1. Open the cap by turning it slightly counterclockwise to allow accumulated pressure to escape.
2. Unscrew the cap completely and open.
3. If the coolant is low, slowly add coolant until the correct level is reached – do not overfill.

The coolant consists of water and extended-duty antifreeze with corrosion inhibitor. The mixing ratio of 50 to 50 must be maintained all the year round due to the required corrosion resistance. No other additives are required.

Replace the coolant every 4 years.

BRAKE FLUID



Warning lamp



If the brake warning lamp comes on with the parking brake released: The brake fluid level is too low, see page 15.



Brake warning lamp for Canadian models.

Adding brake fluid

To add brake fluid or to determine and correct the cause of brake fluid loss, consult your MINI center. Your MINI center is familiar with the specifications for factory-approved brake fluids (DOT 4).

Brake fluid loss may result in extended brake pedal travel. If this occurs, refer to the information on page 79.



Brake fluid is hygroscopic, that is, it absorbs moisture from the air over time.

In order to ensure the brake system's safety and reliability, have the brake fluid changed every two years by a MINI center, see also page 57 and the Service and Warranty Information Booklet (US models)/Warranty and Service Guide Booklet (Canadian models). Brake fluid is toxic and also damages vehicle paintwork. Always store brake fluid in tightly-closed original containers kept well away from the reach of children.

Do not spill the brake fluid and do not fill the brake fluid reservoir beyond the "MAX" mark. The brake fluid could ignite upon contact with hot engine parts and cause serious burns. ◀



Comply with the applicable environmental laws regulating the disposal of brake fluid. ◀

MINI MAINTENANCE SYSTEM



The MINI Maintenance System has been designed as a reliable means of providing maximum driving and operating safety – and as cost-effectively as possible for you. Please bear in mind that regular maintenance is not only necessary for the safety of your vehicle, but also plays a significant role in maintaining the resale value of the vehicle.

Service Interval Display

While conventional systems specify maintenance according to rigid distances driven, the MINI Maintenance System takes account of the operating conditions of the vehicle, for distances can be driven in many different ways:

From the point of view of maintenance, 60.000 miles (100.000 km) of short-distance driving cannot be regarded in the same way as 60.000 miles (100.000 km) of long-distance highway travel.

The condition-based MINI Maintenance System includes the Engine Oil Service and Inspections I and II.

Determining the maintenance intervals according to the actual use of the vehicle covers every kind of operating situation. People who drive very little – much less than 6.000 miles (10.000 km) per year – should have the engine oil changed at least every 2 years since oil deteriorates over time, regardless of use.

For more information on the Service Interval Display, see page 57.

Service and Warranty Information Booklet (US models)/Warranty and Service Guide Booklet (Canadian models)

For additional information on maintenance intervals and procedures, please refer to the Service and Warranty Information Booklet (US models) or the Warranty and Service Guide Booklet (Canadian models).

As a precaution against rust, it is advisable to have the body checked for damage from rocks or gravel at the same time, depending upon operating conditions.

 Have your vehicle's maintenance and repairs performed at your MINI center.

Be sure that all maintenance work is confirmed in the Service and Warranty Information Booklet (US models) or the Warranty and Service Guide Booklet (Canadian models). These entries are your proof that the vehicle has received regular maintenance. They are also a requirement for warranty claims. ◀

CARING FOR YOUR VEHICLE

Suitable car-care products

 Use the cleaning and car-care products available at your MINI center. ◀

Washing your vehicle

You can wash your new MINI from the outset in automatic car washes, though you should use brushless car washes.

 When using steam jets or high-pressure washers, ensure that you keep the jets sufficiently far away from the vehicle. If the jet is too close or the pressure is too high, this can lead to damage or initial damage that can develop into more serious damage. Water that enters vehicle components can lead to damage over the long term. ◀

 After washing the vehicle, apply the brakes briefly to dry them, otherwise water can reduce braking efficiency over the short term and the brake rotors can corrode. ◀

 Switch the rain sensor off when passing through an automatic car wash, see page 51. Failure to do so could result in damage caused by undesired wiper activation. ◀

Rod antenna

 If necessary, before entering a car wash or garage with elevator ramp for example, remove the rod antenna. To do so, grip the rod antenna at the base and unscrew it from the antenna foot by turning it to the left. ◀

Headlamps

 When cleaning the headlamps, please observe the following: do not clean by wiping with a dry cloth (scratches). Never use abrasives or strong solvents to clean the covers. Remove dirt and contamination (such as insects) by soaking with shampoo and then rinsing with plenty of water. Always use a deicer spray to remove accumulated ice and snow – never use a scraper. ◀

Vehicle paintwork

Regular care contributes greatly to driving safety and value retention.

Environmental influences varying from one region to the next can affect the vehicle paintwork. Please base the frequency and scope of car care on these various influences.

Care of upholstery

Depressions that come about on the upholstery material of the seats in daily use can be brushed out using a slightly damp brush against the grain.

The fact that velour lays down is not a quality defect, but rather is inevitable in the case of home textiles or clothing materials.

In the case of strong sunlight and longer parking periods, cover the seats or all windows to prevent discoloration.

Care of special parts

- ▷ Light-alloy wheels:
Use wheel cleaner especially during the winter months, but do not use any aggressive, acidic, strong alkali or rough cleansers or steam jets above 140 °F (60 °C) (observe the manufacturer's operating instructions)
- ▷ Chrome parts* such as cooler grille, door handles, etc.:
Especially if exposed to road salt, carefully clean these parts with plenty of water and possibly with a shampoo additive. For additional treatment, use chrome polish

CARING FOR YOUR VEHICLE

- ▷ Rubber parts:
Treat only with water or rubber care products
- ▷ Plastic parts, imitation leather surfaces, headliner, lamp glass, covering glass for the instrument cluster, as well as matt black molded parts:
Clean with water and, if necessary, plastic care products. Do not dampen seats and the headliner. Never use solvents such as lacquer thinner, heavy-duty grease remover, fuel or similar
- ▷ Safety belts:
Only clean using mild soap, leaving the belts fitted; do not dry clean, as the fabric can be destroyed.
Always unroll automatic safety belts when dry. Dirty safety belts prevent unrolling and thus negatively affect safety
- ▷ Floor carpets and floor mats*:
If heavily soiled, clean using interior cleaner. Floor mats can be removed to allow the interior to be cleaned
- ▷ Wiper blades:
Clean with soapy water. Replace wiper blades twice a year, before and after the cold season. This is particularly important on vehicles fitted with a rain sensor.



Use only wiper blades which have been approved by the manufacturer. ◀

Leather care

The leather* used by the manufacturer is a high-quality natural product processed using state-of-the-art methods, and it will retain its quality level for many years if cared for appropriately.

Regular cleaning and care are necessary, as dust and road dirt scratches in pores and creases and lead to heavy wear as well as premature brittleness of the leather surface. This is why you should use a cloth or vacuum cleaner to remove dust from the leather on a regular basis.

As dirt and grease can slowly affect the protective layer of the leather, the cleaned leather surfaces must be treated with leather care agent. This also helps to avoid electrostatic charges.



Cleaning agents can contain hazardous or health-damaging substances. For this reason, always observe the warnings on the package. For interior cleaning, always open the doors or windows of the vehicle. Do not use any products (e.g. solvents) that are not intended for cleaning the vehicle. ◀

VEHICLE IMMOBILIZATION

Your MINI center will be glad to advise you on what is important if the vehicle is to be decommissioned for longer than three months.

OBD INTERFACE SOCKET



The interface for onboard diagnostics is located on the driver's side, behind a cover located beneath the instrument panel. The cover has the letters "OBD" on it.

This interface makes it possible to access data on emissions-related components using special equipment.

TECHNICAL MODIFICATIONS

Any MINI center will be glad to inform you of the advisability, legal regulations and factory recommendations for technical modifications to the vehicle. To do so, they require the vehicle identification number from your vehicle documents.

CALIFORNIA PROPOSITION 65 WARNING

California laws require us to state the following warning:



Engine exhaust, some of its constituents, and certain vehicle components contain or emit chemicals known to the State of California to cause cancer and birth defects or other reproductive harm. ◀



OVERVIEW

OVERVIEW

CONTROLS

CONTROLS

OPERATION, CARE, MAINTENANCE

OPERATION

OWNER SERVICE PROCEDURES

REPAIRS

TECHNICAL DATA

DATA

INDEX

INDEX

ONBOARD TOOL KIT



Storage location

The illustration shows an example of the tire change set.

Depending on the level of equipment, your MINI is fitted with a special onboard tool kit stored at the following locations:

Tire change set for space-saver spare tire:
In the luggage compartment under the floor mat.

Tool bag for safety tires:

In the left of the luggage compartment, behind the side trim panel beside the first-aid kit, see page 113.

WINDSHIELD WIPER BLADES



Windshield wiper

1. Rotate the wiper arm completely out from the windshield
2. Set the wiper blade at an angle
3. Press the securing spring (arrow)
4. Unhook the wiper blade towards the windshield
5. Pull the wiper blade past the wiper arm toward the top
6. Insert the new wiper blade
7. Press into position until you hear it engage.

 Use only wiper blades which have been approved by the manufacturer. ◀



Rear window wiper

1. Rotate the wiper arm completely out from the windshield
2. Turn the wiper blade as far as it will go to the rear, see arrow
3. Press the wiper blade against the limit and thus out of the mounting
4. Press the new wiper blade into the mounting.

LAMPS AND BULBS

Proceed carefully when handling lamps and bulbs. If you are not familiar with any of the procedures, consult your MINI center.

 Do not touch the glass portion of a new bulb with your bare hands since even small amounts of impurities burn into the surface and reduce the service life of the bulb. Use a clean cloth, paper napkin, or a similar material, or hold the bulb by its metallic base. ◀

Replacement bulbs are available from your MINI center.

 Whenever working on the electrical system, switch off the electrical accessory you are working on or disconnect the cable from the negative terminal of the battery. Failure to do this could result in short circuits.

To prevent injuries and damage, comply with any instructions provided by the bulb manufacturer. ◀

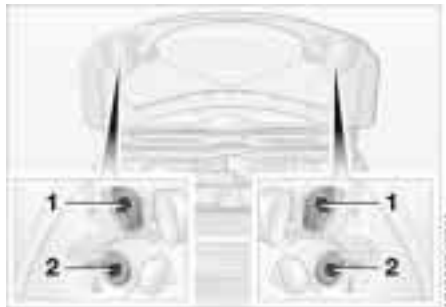

1 Low beams

H7 bulb, 55 Watts

2 High beams

H7 bulb, 55 Watts

 The H7 bulb is pressurized. Therefore, wear safety glasses and protective gloves. Failure to observe these precautions can result in physical injury if the bulb breaks. ◀

1. Pull off the cover panel of the corresponding lamp
2. Press the securing wire outwards
3. Fold the securing wire downwards
4. Remove and replace the bulb.

 When cleaning the headlamps, please observe the following: do not clean by wiping with a dry cloth (scratches). Never use abrasives or strong solvents to clean the covers. Remove dirt and contamination (such as insects) by soaking with shampoo and then rinsing with plenty of water. Always use a deicer spray to remove accumulated ice and snow – never use a scraper. ◀

Xenon lamps*

The service life of these bulbs is very long and the probability of a failure is very low, provided that they are not switched on and off an unusual number of times. If one of these bulbs should nevertheless fail, it is possible to continue driving with great caution using the fog lamps, provided traffic laws in your area do not prohibit this.

 Because of the extremely high voltages involved, any work on the xenon lighting system should be carried out by technically-qualified personnel only. Otherwise, there is a risk of fatal injury. ◀

LAMPS AND BULBS



Turn signal indicators, front

21 Watt bulb

1. Open the hood
2. Reach into the opening for the turn signal indicators from above
3. Apply gentle pressure to the bulb holder while turning it to the left
4. Remove and replace the bulb.

Parking lamps and standing lamps

5 Watt bulb

The parking lamps and standing lamps are integrated in the lamp housing of the turn signal indicator.

1. Turn the bulb holder to the left and pull out
2. Remove and replace the bulb.



Side turn signal indicators

5 Watt bulb

1. Press the bulb towards the rear of the vehicle and remove
2. Remove and replace the bulb.

Side marker lamps

Side marker lamps in the wheelhouse paneling of the bumper.

Please contact a MINI center in case of a malfunction.



Fog lamps*

H7 bulb, 55 Watts

Please contact a MINI center in case of a malfunction.

LAMPS AND BULBS



Tail lamps

Rear lamp (3): 21/5 Watt bulb
Other bulbs: 21 Watts

- 1 Rear fog lamp (not active)
- 2 Turn signal indicator
- 3 Rear lamp
- 4 Rear lamp/brake lamp

red
yellow
red
red

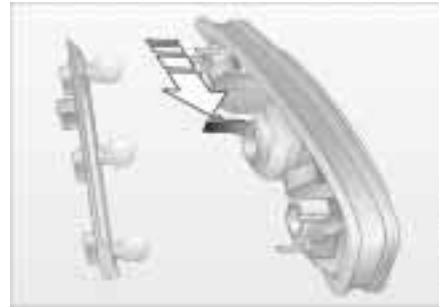

To make this clear, the illustration shows a dismantled tail lamp with the bulb holder removed. All of the bulbs are integrated in the bulb holder.

To reach the bulb holder, remove the cover of the side trim panel in the luggage compartment.

Replacing bulbs

1. Unplug the power supply
2. Release the bulb holder, see arrow, and remove
3. Apply gentle pressure to the bulb while turning it to the left
4. Remove and replace the bulb
5. Plug in the power supply receptacle
6. Press the bulb holder into position until you hear it engage.



Backup lamp

Access to the lamp via the rear or underside of the bumper.

1. Press the clips together
2. Push the lamp out of the bumper
3. Apply gentle pressure to the bulb while turning it to the left
4. Remove and replace the bulb.

LAMPS AND BULBS



Center (high-mount) brake lamp

LED strip on the tailgate.

Please contact a MINI center in case of a malfunction.

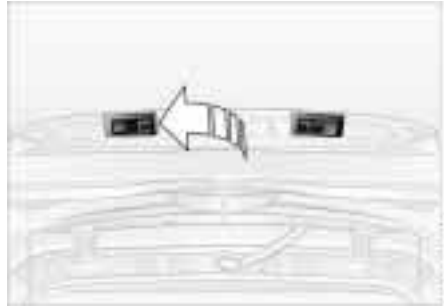

License plate lamps

5 Watt bulb

1. Apply a screwdriver to the recess and lever out the lamp cover
2. Replace the bulb.



Interior lamps

Interior lamp (6 Watt xenon bulb)

1. Press out the lamp cover with a screwdriver
2. Remove and replace the bulb.

Reading lamps (2 x 6 Watt xenon bulbs)

1. Press out the lamp cover with a screwdriver
2. Unscrew the entire lamp with a screwdriver
3. Remove the bulb from above and replace.

LAMPS AND BULBS



Illuminated vanity mirror

Lamps in the vanity mirror in the sun visor.

Please contact a MINI center in case of a malfunction.



Luggage compartment lamps

5 Watt bulb

1. Press the lamp cover with a screwdriver to the left and press out
2. Remove and replace the bulb.

Footwell lamps

5 Watt bulb

1. Press out the lamp cover with a screwdriver
2. Remove and replace the bulb.

Glove compartment lamp

5 Watt bulb

1. Press out the lamp cover with a screwdriver
2. Remove and replace the bulb.

REPAIRING A FLAT TIRE

 Safety measures in the event of a flat tire:

Stop the vehicle as far as possible from passing traffic. Switch on the hazard warning flashers.

Turn the steering wheel to the straight-ahead wheel position and engage the steering lock. Engage the parking brake and shift into 1st or reverse gear (selector lever in P).

All passengers should be outside the vehicle and well away from your immediate working area (behind a guardrail, for instance).

If a warning triangle or portable hazard warning lamp is available, set it up on the roadside at an appropriate distance from the rear of the vehicle. Comply with all safety guidelines and regulations. ◀

In the event of a flat tire, different procedures should be followed depending on the equipment included in your MINI:

- ▷ Vehicles with space-saver spare tire, see next column
- ▷ Vehicles with safety tires, see page 110.

CHANGING TIRES – MINI WITH SPACE-SAVER SPARE TIRE *

 Additional safety measures in the event of a wheel change: change the wheel only on a level, firm surface which is not slippery.

Avoid jacking the vehicle on a soft or slippery support surface (snow, ice, loose gravel, etc.), as either the vehicle or the jack could slip sideways.

Do not use a wooden block or similar object as a support base for the jack, as this would prevent it from extending to its full support height and reduce its load-carrying capacity.

Do not lie under the vehicle or start the engine when the vehicle is supported by the jack – risk of fatal injury. ◀

To change a space-saver tire, proceed as follows:

- ▷ Remove the space-saver spare tire, see page 107
- ▷ Prepare the vehicle, see page 108
- ▷ Jack up the vehicle, see page 108
- ▷ Fit the space-saver spare tire, see page 109
- ▷ Tighten the lug bolts, see page 109
- ▷ Drive with space-saver spare tire, see page 109.



Tire change set

On vehicles with a space-saver spare tire, the tire change set is stored in the luggage compartment under the floor mat.

- 1 Chock, folding
- 2 Hubcap remover
- 3 Wheel stud wrench
- 4 Jack
- 5 Spanner
- 6 Tow fitting
- 7 Lifting handle

CHANGING TIRES – MINI WITH SPACE-SAVER SPARE TIRE*



Removing the space-saver spare tire

The screw connection of the space-saver spare tire is in the luggage compartment under the floor mat, on the base of the storage compartment for the tire change set.

1. Loosen the screw connection using the wheel stud wrench
2. Take out the cover panel

3. Screw the lifting handle from the onboard tool kit onto the thread
4. Raise the lifting handle slightly



5. Squeeze the securing springs
6. The space-saver spare tire is released and must be held by the lifting handle
7. Lower the space-saver spare tire with the lifting handle
8. Unscrew the lifting handle again

CHANGING TIRES – MINI WITH SPACE-SAVER SPARE TIRE *



9. Pull out the space-saver spare tire towards the rear underneath the vehicle
10. Position the space-saver spare tire with the valve facing upwards
11. Unscrew the valve extension from the valve of the space-saver spare tire
12. Unscrew the dust cap from the extension and attach to the space-saver spare tire.

Preparing the vehicle

 Read and comply with the safety precautions provided on page 106. 

1. Secure the vehicle to prevent it from rolling:
Place the folding chock behind the front wheel on the other side of the vehicle; on downward inclines, place it in front of this wheel.
If the wheel is changed on a surface with a more severe slope, take additional precautions to secure the vehicle from rolling
2. Loosen the lug bolts by a half turn.



Jacking up the vehicle

1. Place the jack at the jacking point closest to the wheel.
The jack base must be perpendicular to the surface beneath the jacking point

CHANGING TIRES – MINI WITH SPACE-SAVER SPARE TIRE *



2. Insert the jack head for jacking up in the square recess of the jacking point
3. Jack the vehicle up until the wheel you are changing is raised from the ground.

 The vehicle jack is designed for changing wheels only. Do not attempt to raise another vehicle model with it or to raise any load of any kind. Do so could cause accidents and personal injury. ◀

Fitting the space-saver spare tire

1. Unscrew the lug bolts and remove the wheel
2. Remove accumulations of mud or dirt from the mounting surfaces of the wheel and hub. Clean the lug bolts
3. Fit the space-saver spare tire
4. Screw at least two lug bolts finger-tight into opposite bolt holes
5. Screw in the remaining bolts
6. Tighten all the lug bolts firmly in a diagonal pattern
7. Lower the vehicle
8. Remove the jack.

Tightening the lug bolts

Tighten the lug bolts in a diagonal pattern.

 As soon as possible, have the secure seating of the lug bolts (tightening torque 72 ftlb (100 Nm)) checked using a calibrated torque wrench. Otherwise, a wheel that might come loose can lead to a severe accident. ◀

Replace the defective tire as soon as possible and have the new wheel/tire assembly balanced.

Driving with the space-saver spare tire

Drive cautiously. Do not exceed a speed of 50 mph (80 km/h).

You can expect changes in vehicle handling such as delayed braking response, longer braking distances, and changes in self-steering properties in marginal stability limits.

 Only one space-saver spare tire may be mounted at one time. Reinstall wheels and tires of the same size and specification as soon as possible. Maintain prescribed tire pressures, see page 80. ◀

 Only use full hubcaps approved by the manufacturer. Otherwise there is no guarantee that the hubcap fits securely. The hubcap must not be fitted to the space-saver spare tire, as it could be damaged. ◀

 Check and correct the tire inflation pressure at the earliest opportunity. ◀

FLAT TIRE – SAFETY (RUN-FLAT) TIRES*



You will recognize safety tires by a circular symbol containing the letters RSC on the side of the tire.

Safety tires consist of self-contained tires and special rims. The tire reinforcement ensures that the tire retains some residual safety in the event of pressure drop and driving remains possible to a restricted degree.

 The reinforcement on the flanks of the safety tires means that it is usually not possible to detect an air loss from outside. ◀

Flat tire

The yellow indicator lamp in the instrument cluster lights up to indicate a flat tire. In addition, a gong sounds, see pages 17, 62.

1. Reduce vehicle speed carefully to under 50 mph (80 km/h), avoiding hard brake applications and steering maneuvers
2. Do not exceed a speed of 50 mph (80 km/h)
3. Identify damaged tires; check tire inflation pressures on all four wheels at the next opportunity, see page 80
4. Correct the tire inflation pressure if you wish to continue your journey and this is permitted, see next column
5. Have damaged tires changed by your MINI center, see page 84.

 Your MINI center has the information needed for working with safety tires and is equipped with the necessary special tools. They provide advice if you wish to replace the tires on your MINI or wish to re-equip from summer to winter tires – or vice versa, see also pages 80, 84, 85. ◀

 For safety reasons, do not have a damaged safety tire repaired. ◀

Continuing driving with a damaged tire

Driving can continue under certain conditions with safety tires, depending on the vehicle load and the severity of the tire damage, at a maximum speed of 50 mph (80 km/h).

You can determine the possible mileage for continued driving on the basis of the following general indications:

- ▷ Tire inflation pressure 0 bar (0 psi): approx. 95 miles (150 km)
- ▷ Tire inflation pressure 0.5 bar – 1 bar (7.2 psi – 14.5 psi): approx. 300 miles (500 km)
- ▷ Tire inflation pressure greater than 1 bar (14.5 psi): approx. 600 miles (1,000 km).

BATTERY

Location in the MINI COOPER

The battery is located in the engine compartment.

Exact location, see page 87.

Location in the MINI COOPER S

The battery is located in the luggage compartment under the floor mat.

Battery care

The battery is absolutely maintenance-free, that is, the original electrolyte will normally last for the service life of the battery under moderate climatic conditions.



For all questions regarding the battery, please consult your MINI center. ◀

Charging the battery

Only charge the battery in the vehicle via the terminals in the engine compartment with the engine switched off, see "Jump-starting" on page 113.



Whenever working on the electrical system, disconnect the cable from the negative terminal of the battery. Failure to do this could result in fire hazards or injury due to short circuits. ◀



Return used batteries to a recycling point or your MINI center. Maintain the battery in an upright position for transport and storage. Secure the battery to prevent it from tilting during transport. ◀

FUSES



If an electrical device fails, switch it off and check the fuse.

Plastic tweezers that you can use to pull fuses out of their sockets can be found in the fuse box of the interior, see next column.

In the engine compartment

To the right of the battery.

Open the cover panel of the fuse box. To do so, press the clip fastener.

In the interior

On the left side of the footwell in the side trim panel.

Open the cover panel of the fuse box. To do so, press the fastener.



Do not attempt to repair a blown fuse or replace it with a fuse of a different color or amperage rating. To do this could cause a fire in the vehicle resulting from a circuit overload. ◀



If a fuse blows a second time, have the cause of the damage rectified by your MINI center. ◀

WARNING TRIANGLE*



The warning triangle is located beneath the luggage compartment cover.

 Comply with legal requirements requiring you to carry a hazard warning triangle in the vehicle. ◀

FIRST-AID KIT*



The first-aid kit is located together with the onboard tool kit in the left of the luggage compartment, behind the side trim panel.

 Some articles in the first-aid kit are perishable. For this reason, check the expiration dates of each of the items regularly, and replace any whose expiration dates have passed.
Source: any pharmacy.
Comply with legislation requiring you to carry a first-aid kit in the vehicle. ◀

JUMP-STARTING

Do not use spray starter fluids to start the engine.

When your battery is discharged, you can use two jumper cables to start your vehicle with power from the battery in a second vehicle. By the same token, you can provide another vehicle with starting assistance. To do so, use only jumper cables with fully insulated terminal clamps.

 Do not touch live wiring and cables on a running engine. There is a risk of fatal injury if you do this. Carefully observe the following instructions to avoid personal injury and/or damage to either vehicle or both vehicles. ◀

JUMP-STARTING

Preparation for jump-starting

1. Check whether the battery of the support vehicle has 12 Volts and approximately the same capacity (Ah) (printed on the battery)
2. Switch off the engine of the support vehicle
3. Switch off any electrical systems and components in both vehicles – except for the hazard warning flashers of the support vehicle.
 - ▷ Do not disconnect the discharged battery from the vehicle electrical system
 - ▷ Make certain that there is no contact between the bodywork of the two vehicles – short circuit hazard!
4. With the battery of the MINI COOPER, remove the cover panel. To do so, press both clips at the same time or with the MINI COOPER S, open the cover of the positive terminal connection (for jump-starting)*, see arrow 1.

Connect the jumper cables

 Adhere to the sequence also when providing support for other vehicles; failure to observe this procedure can lead to sparks at the terminals and pose an injury hazard. ◀



1. On the MINI COOPER S, the positive terminal connection (for jump-starting), see arrow 1, functions as the positive battery terminal.
Use the jumper cable (+) to set up a connection between the positive terminal of the discharged battery and the positive terminal of the support battery
2. Use the second jumper cable (-) to set up the connection between the negative terminals of both vehicles.
To do so:
 - ▷ Connect one terminal clamp to the negative terminal and/or to an engine or body ground of the support vehicle
 - ▷ Connect the second terminal clamp to the negative terminal of the battery and/or to an engine or body ground of the vehicle to be started. For the MINI, see arrow 2.

Performing the jump-start

1. Start the engine of the vehicle providing the current and allow to run at a fast idle speed for several minutes
2. Start the engine on the vehicle with the discharged battery in the usual manner.
 - ▷ If the first start attempt is not successful, wait a few minutes before another attempt in order to allow the discharged battery to recharge.

1.  On the MINI:
Before disconnecting the jumper cables, switch on the lighting, rear window defroster and the highest blower speed as well as the engine for at least approx. 10 seconds to prevent a voltage surge from the regulator to the electrical systems and components. ◀
3. Then disconnect the jumper cables in the reverse order.

 Depending on the cause of the malfunction, have the battery checked and recharged at your MINI center. ◀

TOW-STARTING AND TOWING



For towing, use either a tow bar or a nylon rope or nylon belts that prevent sudden jerking movements.

Tow fitting

The screw-in tow fitting is stored in the onboard tool kit; be sure that it remains in the vehicle at all times. This fitting is designed for installation in the tow sockets located at the front and rear of the vehicle. It is intended for towing on paved road surfaces only.

Access to tow sockets

Use a suitable object (e.g. credit card, screwdriver) to press out the covers from the recess.

 Screw the tow fitting in until it bottoms firmly. If this is not done, the threads could be damaged. Never attach tie-down hooks, chains, straps, or tow hooks to tie rods, control arms, or any other part of the vehicle suspension, as severe damage to these components will occur, leading to possible accidents. ◀

Tow bars

If the tow fittings of the two vehicles are not directly opposite one another, please note:

- ▷ Clearance and maneuvering capability will be strictly limited in corners
- ▷ The inclination of the tow bar generates lateral force (critical above all if the road surface is slippery).

 Do not tow a vehicle that is heavier than the towing vehicle, otherwise it will no longer be possible to control vehicle response. ◀

TOW-STARTING AND TOWING

Tow-starting

 On vehicles with Continuously Variable automatic Transmission (CVT), it is not permitted to start the engine by tow-starting. The transmission could be damaged.

For jump-starting, see page 113. ◀

Only tow-start vehicles with a catalytic converter when the engine is cold, otherwise, unburned fuel in the catalytic converter could catch fire. It is better to use jumper cables.

1. Switch on the hazard warning flashers (comply with national regulations)
2. Ignition key in position 2
3. Engage 3rd gear
4. Tow-start with the clutch pedal pressed
5. Slowly release the clutch
6. When the engine starts, press the clutch pedal again
7. Switch off the hazard warning flashers.

Have the cause of the starting problems rectified by your MINI center.

Towing

 Only tow vehicles with Continuously Variable automatic Transmission (CVT) with the front wheels raised or on a special transport vehicle, otherwise the transmission can be damaged. ◀

- 1 Ignition key in position 1:
The brake lamps, turn signals, horn and windshield wipers can be operated
- 2 Switch on the hazard warning flashers (comply with national regulations).

If the electrical system has failed, place some kind of warning on the towed vehicle, e.g. a sign or warning triangle in the rear window.

 Ensure that if the electrical system has failed the ignition key is in position 1, otherwise the steering lock could engage and make it impossible to steer the vehicle.

When the engine is not running, there is no power-assist. This means that greater effort is required for braking and steering. ◀

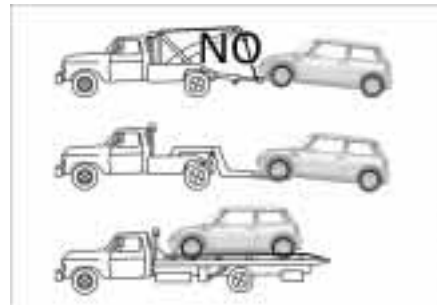

Towing with a commercial tow truck

- ▷ Do not tow with sling-type equipment
- ▷ Use a wheel-lift or flatbed carrier
- ▷ Please comply with applicable towing laws.

 Never allow passengers to ride in a towed vehicle for any reason. ◀



OVERVIEW

OVERVIEW

CONTROLS

CONTROLS

OPERATION, CARE, MAINTENANCE

OPERATION

OWNER SERVICE PROCEDURES

REPAIRS

TECHNICAL DATA

DATA

INDEX

INDEX

ENGINE DATA

		MINI COOPER	MINI COOPER S
Displacement	cu in/cm ³	97.52/1,598	97.52/1,598
Number of cylinders		4	4
Maximum output at engine speed	kW/bhp rpm	85/115 6,000	120/163 6,000
Maximum torque at engine speed	lb ft/Nm rpm	110/149 4,500	155/210 4,000
Compression ratio	ϵ	10.6	8.3
Stroke	in/mm	3.38/85.8	3.38/85.8
Bore	in/mm	3.03/77	3.03/77
Fuel-injection system		Digital electronic engine-management system	

DIMENSIONS

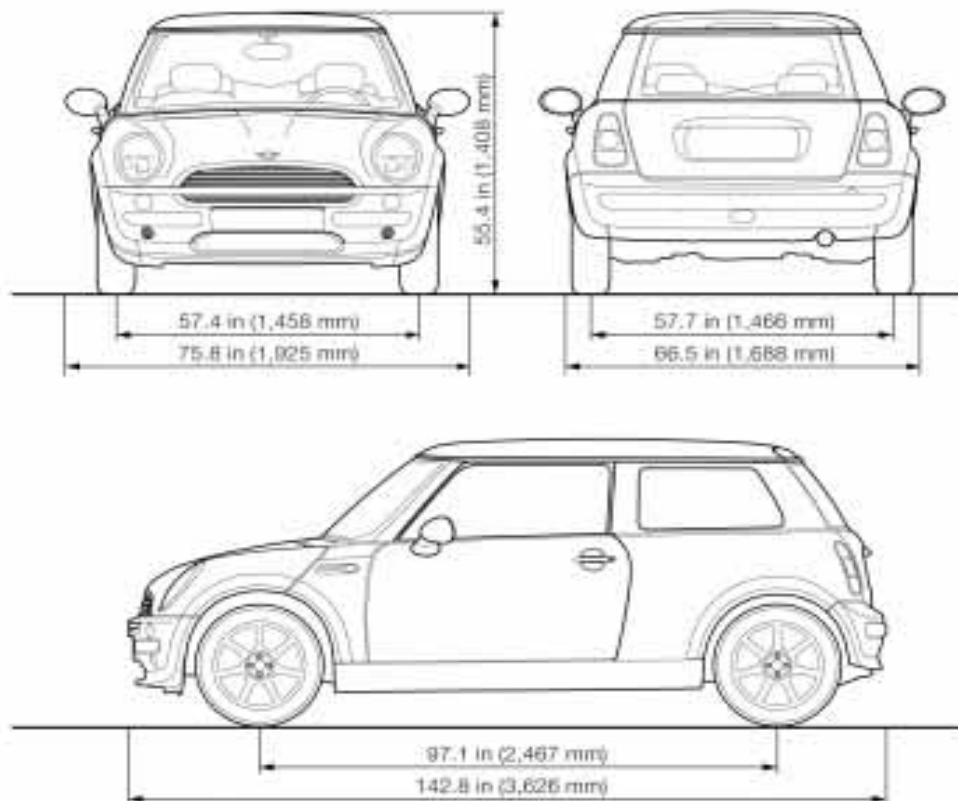

All dimensions specified in inches (millimeters). Smallest turning circle 35 ft (10.66 m).

WEIGHTS

		MINI COOPER	MINI COOPER S
Curb weight, ready for operation, with 165 lbs./75 kg load, 90% full tank, options not included			
with manual transmission	lbs./kg	2,480/1,125	2,678/1,215
with Continuously Variable automatic Transmission (CVT)	lbs./kg	2,535/1,150	–
Approved gross vehicle weight			
with manual transmission	lbs./kg	3,263/1,480	3,461/1,570
with Continuously Variable automatic Transmission (CVT)	lbs./kg	3,318/1,505	–
Approved front axle load	lbs./kg	1,918/870	1,962/890
Approved rear axle load	lbs./kg	1,543/700	1,675/760
Approved roof load (with special MINI roof rack)	lbs./kg	165/75	165/75
Luggage compartment capacity	cu ft/liters	5.3/150	5.3/150

CAPACITIES

			Notes
Fuel tank Reserve	gal./liters gal./liters	approx. 13.2/50 approx. 2.1/8	Fuel quality, see page 78
Windshield washer/ headlamp cleaning system	quarts/liters quarts/liters	approx. 2.6/2.5 approx. 2.6/2.5	More details, see page 89
Cooling system including heater circuit	quarts/liters	5.6/5.3 MINI COOPER 6.3/6.0 MINI COOPER S	More details, see page 91
Engine oil and filter change	quarts/liters	4.7/4.5 MINI COOPER 4.7/4.5 MINI COOPER S	Longlife Oil More details, see page 89
Manual transmission, incl. differential	quarts/liters	approx. 2.1/2 MINI COOPER approx. 1.8/1.7 MINI COOPER S	Contact your MINI center for more details
Continuously Variable automatic Transmission (CVT), incl. differential	quarts/liters	approx. 4.2/4.0 MINI COOPER	Contact your MINI center for more details

ELECTRICAL SYSTEM

Battery

12V, 55 Ah

Spark plugs

NGK BKR 6 EQUIP



Original MINI parts and accessories
as well as qualified advice is available
at your MINI center. ◀



OVERVIEW

OVERVIEW

CONTROLS

CONTROLS

OPERATION, CARE, MAINTENANCE

OPERATION

OWNER SERVICE PROCEDURES

REPAIRS

TECHNICAL DATA

DATA

INDEX

INDEX

EVERYTHING FROM A TO Z

- A**
- ABS (Antilock Brake System) 16, 17, 78
 - Activated-charcoal filter 69
 - Adjusting
 - backrest 33
 - seats 31
 - steering wheel 35
 - thigh support 33
 - Air conditioner operation 65
 - automatic climate control 68
 - Air conditioner system 64
 - Air distribution
 - air conditioner system 65
 - automatic climate control 68, 69
 - Air pressure 80
 - Air recirculation 65, 68
 - Air supply
 - air conditioner system 65
 - automatic climate control 69
 - Air vents 66, 69
 - Air, dry 65, 68
 - Airbags 16, 31, 37
 - All-season tires 85
 - Antenna 94
 - Antifreeze 91
 - Antilock Brake System (ABS) 16, 17, 78
 - Aquaplaning 76
 - ASC+T (Automatic Stability Control plus Traction) 16, 17, 60
 - Ashtray 70
 - Automatic air distribution 68
 - Automatic air supply 68
 - Automatic car wash 94
 - Automatic cruise control 53
 - Automatic dimming of interior rearview mirror 37
 - Automatic program, see Automatic air distribution 68
 - Automatic Stability Control plus Traction (ASC+T) 16, 17, 60
 - Average fuel consumption 59
 - Average speed 59
 - Axle loads 122
- B**
- Backrest, adjusting 33
 - Backup lamps 45
 - bulb replacement 103
 - Bar, towing 115
 - Battery 111, 113, 114, 124
 - capacity 124
 - charge current 15
 - charging 111
 - maintenance 111
 - Battery changing
 - remote control 22
 - Battery, remote control 22
 - Beverage holder 70
 - Blower 65, 69
 - BMW 6
 - Bore 120
 - Brake 16
 - Brake fluid change 57
 - Brake fluid level 15, 79, 92
 - Brake hydraulic system 15
 - Brake lamp
 - bulb replacement 103
 - Brake pads 76, 79
 - Brake rotors 76
 - Brake system 76, 79
 - brake fluid 92
 - Brakes 79
 - Break-in procedure 76
 - Breaking in the vehicle 76
 - Bridging 113, 114
 - Bulb replacement 101
 - backup lamps 103
 - brake lamp, third 104
 - footwell lamps 105
 - front fog lamps 102
 - front turn signal indicators 102
 - glove compartment lamp 105
 - high beams 101
 - interior lamps 104
 - license plate lamp 104
 - low beams 101
 - luggage compartment lamps 105
 - parking lamps 102
 - rear lamps 103
 - side turn signal indicators 102
 - standing lamps 102
 - tail lamps 103
 - vanity mirror 105

EVERYTHING FROM A TO Z

C

- California Proposition 65
 - Warning 97
 - Can holder, see Beverage holder 70
 - Car wash 94
 - Car-care products 94
 - Care
 - chrome parts 94
 - floor mats 95
 - imitation leather 95
 - leather 95
 - light-alloy wheels 94
 - of upholstery 94
 - plastic parts 95
 - rubber parts 95
 - safety belts 95
 - special parts 94
 - windshield wipers 95
 - Cargo 72
 - securing 72
 - stowing 72
 - Caring for your vehicle 94
 - Cassette player, see separate Owner's Manual
 - CD changer, see separate Owner's Manual
 - CD player, see separate Owner's Manual
 - Center (high-mount) brake lamp
 - bulb replacement 104
 - Central locking system 23, 26
 - Changing tires
 - space-saver spare tire 106
 - Child seat 38
 - Child-restraint systems 38
 - Chrome parts 94
 - Cigarette lighter 70
 - socket 70
 - Cleaning rear window 52
 - Cleaning windshield 52
 - Clock 58
 - Closing
 - from inside 26
 - from outside 23
 - Clothes hooks 77
 - Clutch 76
 - Cockpit 12
 - Combination of wheels/tires 84
 - Compact Disc player, see separate Owner's Manual
 - Compression ratio 120
 - Computer 58
 - average fuel consumption 59
 - average speed 59
 - cruising range 59
 - exterior temperature 59
 - Condensation 65, 68
 - Consumption 59
 - Consumption display 55
 - Contents 2
 - Continuously Variable automatic Transmission (CVT)
 - electronic transmission control module (EP) 48
 - gear display 48
 - ignition 42
 - interlock 42
 - manual mode 47
 - parking 47
 - reverse gear 47
 - selector lever shiftlock 42, 46
 - shiftlock 46
 - Sport program 47
 - Steptronic 46
 - towing 116
 - tow-starting 116
 - transmission fault 48
- Control elements 12
 - Convenience feature
 - sliding/tilt sunroof 25
 - windows 25
 - Convenience operation
 - via central locking system 26
 - Coolant 91
 - Coolant level 91
 - Coolant temperature gauge 56
 - Cooling 65, 68
 - Copyright notice 6
 - Correct sitting posture with airbags 31
 - safety belt 31
 - Cruise control 17, 18, 53
 - Cruising range 59
 - Cup holder, see Beverage holder 70
 - Curb weight 122
 - Currency of the Owner's Manual 7
 - Cylinders 120

EVERYTHING FROM A TO Z

- D**
Dashboard 12
Data
 dimensions 121
 engine 120
 weights 122
Data, technical 120
Daytime driving lamps 49
Decommissioning the vehicle 96
Deep water, see Water on roadways 77
Defrosting position 66
Defrosting windows 69
 air conditioner system 66
 automatic climate control 69
Dimensions 121
Dirt on the paintwork 94
Disc brakes 79
Displacement 120
Display elements 13, 14
 coolant temperature gauge 56
 fuel gauge 55
 indicator and warning lamps 15
 odometer 55
 Service Interval Display 57
 with navigation system 14
- Display lighting 50
Distance remaining 59
Door keys 22
Doors
 locking 24
 manual operation 25
 remote control 23
 unlocking 24
DOT Quality Grades 83
Drink holder, see Beverage holder 70
Driving lamps 49
Driving notes, general 76
Dry air 65, 68
Dynamic Stability Control (DSC) 16, 61
- E**
Easy Entry 33
EBV (Electronic Brake Force Distribution) 16
Electric power windows 28
Electrical defect
 driver's door 25
 sliding/tilt sunroof 30
Electrical system 124
Electronic Brake Force Distribution (EBV) 16
Electronic transmission control module (EP), Continuously Variable automatic Transmission (CVT) 48
Emergency operation
 driver's door 25
 sliding/tilt sunroof 30
 tailgate 27
Engine 76
 electronics 17
 power output 17
 speed 17, 55
 starting 42
 switching off 43
Engine compartment
 MINI COOPER 87
 MINI COOPER S 88
Engine oil 89
 additives 90
 prescribed oils 90
 pressure 15
Entry to the rear 33
EP (electronic transmission control module), Continuously Variable automatic Transmission (CVT) 48
Exterior finish, care 94
Exterior mirrors 36
Eyelets, towing 115
- F**
Failure, tires 62, 106, 110
Filler cap cover 77
Filling capacities 123
Filling, tank 123
First-aid kit 113
Flat tire 62, 106
Flat Tire Monitor 16, 17, 62
Floor carpets 95
Floor coverings 95
Floor mats 95
Fog lamps 50
Foldable rear backrest 71
"Follow me home" lamps 49
Footbrake 79
Footwell lamps
 bulb replacement 105
Front fog lamps 50
 bulb replacement 102
Front seat adjustment 31
Fuel consumption 59
Fuel consumption display 55
Fuel gauge 55
Fuel preparation 120
Fuel quality 78
Fuel reserve indicator 55
Fuel tank capacity 123
Fuses 112

EVERYTHING FROM A TO Z

G

- Gasoline 78
- Gasoline gauge 55
- Gear display 48
 - Continuously Variable automatic Transmission (CVT) 48
- General driving notes 76
- Glove compartment 70
- Glove compartment lamps
 - bulb replacement 105
- Grilles 66, 69
- Gross weight 122

H

- Handbrake 44
- Hazard warning flashers 12
- Head airbags 37
- Head restraints 34
- Headlamp cleaning
 - system 52, 89
 - filling 89
- Headlamp flasher 49
- Headlamps
 - care 94, 101
 - cleaning 52

Heated

- outside mirrors 36
 - rear window 65, 68
 - seats 34
 - windshield 65, 68
 - windshield washer jets 52
- ## Heavy cargo 72
- ## Height 121
- ## High beams 17, 49
- bulb replacement 101
- ## Hood 16, 86
- ## Horn 12
- ## Hubcap remover 100, 106

I

- Ignition lock 42
- Illuminated vanity mirror 36
- Imitation leather 95
- Imprint 6
- Indicator lamps 15
- Individual air distribution 69
- INSPECTION 57
- Instrument cluster, see Display elements 13
- Instrument lighting 50
- Instrument panel 12
- Interface socket
 - for Onboard Diagnostics 96

- Interior lamps 50
 - bulb replacement 104
- Interior rearview mirror 36
 - automatic dimming 37
- Interlock 42
- Interval display 93

J

- Jack 100, 106
- Jump-starting 113, 114

K

- Keys 22
 - multifunction steering wheel 18
- Kickdown 47

L

- Lamps 49, 101
 - backup lamps 103
 - brake lamp 103, 104
 - daytime driving lamps 49
 - fog lamps 50
 - footwell lamps 105
 - front fog lamps 102
 - glove compartment 105
 - high beams 101
 - instrument lighting 50

- interior lamps 50, 104
- license plate lamp 104
- low beams 49, 101
- luggage compartment lamps 105
- parking lamps 49, 102
- reading lamps 50
- rear fog lamp 103
- standing lamps 49, 102
- tail lamp 103
- turn signal indicators 102
- xenon lamps 101
- Lashing eyes 72
- LATCH child-restraint
 - system 41
- Leather care 95
- LED light-emitting diodes 51
- Length 121
- License plate lamp
 - bulb replacement 104
- Light-alloy wheels 94
- "Lights on" warning 49
- Loading 72
- Load-securing devices 72
- Low beams 49
 - bulb replacement 101
- Luggage compartment 72
 - content 122

EVERYTHING FROM A TO Z

Luggage compartment cover 71
Luggage compartment lamp bulb replacement 105
Luggage rack
 see Roof-mounted luggage rack 73
Lumbar support 32

M

M+S tires 85
Maintenance 57, 93
Maintenance System 93
Manual operation
 driver's door 25
 sliding/tilt sunroof 30
 tailgate 27
Manual transmission 45
Manufacturer 6
Master key 22
 initialization 22
MD player, see separate Owner's Manual
Mechanical key 22
MFL (Multifunction steering wheel) 18
Microfilter 66, 69
Mini Disc player, see separate Owner's Manual

MINI Maintenance System 93
MINI manufacturer 6
MINI Mobility System 100
Mirrors 36
Mobility System, see MINI Mobility System 100
Modifications, technical 96
Multifunction steering wheel (MFL) 18
Multifunction switch 49

N

Navigation system, see separate Owner's Manual 14
Non-smoker's equipment package, see Cigarette lighter socket 70
Nozzles 66, 69

O

OBD interface socket 96
Odometer 55
Oil 89
 additives 90
 level 15
 prescribed oils 90
 pressure 15

Oil change intervals, see Service and Warranty Booklet (US models)/Warranty and Service Guide Booklet (Canadian models)
Oil service 57
Old batteries 111
Onboard tool kit 100
Opening
 from inside 26
 from outside 23
Outside temperature display 59

P

Package tray, see Luggage compartment cover 71
Park Distance Control (PDC) 63
Parking brake 16, 44
Parking lamps 49
 bulb replacement 102
Parking lamps/Low beams 49
Parking, vehicle 76
PDC (Park Distance Control) 63
Plastic 95
Pollen 66
Pollen filter 69
Power output 17, 120

Power supply 12 V 70
Power windows 28
Pressure, tires 80, 109

Q

Quality Grading, tire 83

R

Radiator 91
Radio, see separate Owner's Manual
Rain sensor 51
Reading lamps 50
Rear backrest foldable 71
Rear fog lamp 50
 bulb replacement 103
Rear lamps 45, 103
Rear window defroster automatic climate control 68
 heating and climate control 65
Rear window wiper 52
 replacing 100
Rearview mirror 36
Recirculated-air mode air conditioner system 65
 automatic climate control 68

EVERYTHING FROM A TO Z

- Recirculation of air 65, 68
- Reclining seat 31
- Refueling 77
- Remaining distance for service 57
- Remote control 23
 - battery 22
 - battery changing 22
 - initialization 22
- Removing mist, windows 66, 69
- Removing window mist
 - air conditioner system 66
 - automatic climate control 69
- Replacement key 22
- Reporting safety defects 9
- Restraint system 38
- Reverse gear 45, 47
- Rod antenna 94
- Roller sun blind, rear window blind 30
- Rubber parts 95
- Run-flat tire, see Safety tires 80, 84, 85, 110
- S**
 - Safety belts 16, 31, 35, 95
 - adjusting 35
 - Safety lock buttons 26
 - Safety tires 80, 84, 110
 - winter tires 84, 85
 - Screwdriver 100
 - Seats 31
 - Securing cargo 72
 - Selector lever shiftlock 42, 46
 - Service and Warranty Booklet (US models)/Warranty and Service Guide Booklet (Canadian models) 93
 - Service Interval Display 57, 93
 - Shiftlock 46
 - Side airbags 37
 - Side turn signal indicators
 - bulb replacement 102
 - Sitting 31
 - Sliding/tilt sunroof 29
 - convenience feature 25
 - safety function 30
 - Smoker's equipment package 70
 - Snow chains 85
 - Space-saver spare tire
 - changing tires 106
 - Spare key 22
 - Spark plugs 124
 - Speed 120
 - Speeds 85
 - Split rear backrest 71
 - Spray jets 52
 - Standing lamps 49
 - bulb replacement 102
 - Starting 42
 - problems 43, 113, 114, 115
 - with a discharged battery 113, 114
 - Steering lock 42
 - Storage, tires 84
 - Sun visors 36
 - Switches 12
 - Switching off, engine 43
 - Symbols 6
- T**
 - Tachometer 55
 - Tail lamps
 - bulb replacement 103
 - Tailgate 16, 27
 - manual unlocking 27
 - Tank capacity 77
 - Tank content, filling capacities 123
 - Technical data 120
 - Technical modifications 96
 - Temperature
 - automatic climate control 68
 - heating and climate control 65
 - tires 83
 - Temperature display 59
 - engine coolant 56
 - Temperature layering 66, 69
 - Temperatures, high 77
 - The right tires 84
 - Third brake lamp
 - bulb replacement 104
 - Tire change
 - tire change set 106
 - Tire changes between axles 84
 - Tire failure 16
 - safety tires 110
 - space-saver spare tire 106
 - Tire inflation pressure 80, 85
 - Tires 80
 - all-season tires 85
 - break-in 76
 - changing 106
 - condition 82, 85
 - damage 82

EVERYTHING FROM A TO Z

- inflation pressure 80
- M+S tires 85
- replacement 83
- safety tires 80, 84, 85, 110
- snow chains 85
- storage 84
- temperature 83
- the right choice 84
- tread 82
- winter tires 85
- with emergency running properties, see Safety tires 80, 84, 85, 110
- Tools 100
- Torque 120
- Tow bar 115
- Tow fitting 115
- Tow socket for tow fittings 115
- Towing 115
 - with bar 115
 - with Continuously Variable automatic Transmission (CVT) 116
- Towing eyelets 115
- Tow-starting 115, 116
 - with Continuously Variable automatic Transmission (CVT) 116
- Tow-starting and towing 115
- Traction 83
- Trailer nose weight 122
- Transmission 45
- Transmission fault, Continuously Variable automatic Transmission (CVT) 48
- Transporting children safely 38
- Tread wear 83
- Trip odometer 55
- Turn signal indicators 17, 49
 - bulb replacement 102
- U**
- Uniform Tire Quality Grading 83
- V**
- Vanity mirror 36
 - bulb replacement 105
 - illuminated 36
- Vehicle
 - battery 124
 - decommissioning 96
 - dimensions 121
 - exterior finish 94
 - operating 42
 - settings 41
 - washing 94
 - weight 122
- Vehicle Memory 41
- Ventilation 66
 - draft-free 66, 69
- W**
- Warning lamp 15
- Warning triangle 113
- Washer systems 89
- Washer/wiper system 51
- Waste container 70
- Water on roadways
 - deep water 77
- Wearing safety belt 16, 35
- Weights 122
- Wheel and tire combinations 84
- Wheel stud wrench 100, 106, 107
- Wheelbase 121
- Width 121
- Windows, convenience feature 25
- Windshield heating
 - automatic climate control 68
 - heating and climate control 65
- Windshield washer system 51, 89
 - filling 89
- Windshield wipers 51, 100
 - care 95
 - replacing 100
- Winter tires 85
 - all-season tires 85
 - safety tires 84, 85
- Wiper/washer system 51
- Work in the engine compartment 86

EVERYTHING FROM A TO Z

X

Xenon lamps 101

REFUELING

Fuel	
Designation	
AKI:	

Engine oil	
Quality	

The oil volume between the two marks on the dipstick corresponds to approx. 1.1 US quarts (1 liter).

Tire inflation pressure	Summer		Winter	
	front	rear	front	rear
2 persons				
4 persons plus luggage				



To ensure that you always have convenient access to all essential information when you stop for fuel, we recommend that you take the time to fill out the adjoining chart by entering the data that applies to your vehicle.

MINI RECOMMENDS 

DRIVE ME.

01 41 0 156 724 ue

MINI US-En