



OWNER'S MANUAL

MINI CLUBMAN



**COOPER
COOPER S
JOHN COOPER
WORKS**

Congratulations on your new MINI

This Owner's Manual should be considered a permanent part of this vehicle. It should stay with the vehicle when sold to provide the next owner with important operating, safety and maintenance information.

We wish you an enjoyable driving experience.

© 2010 Bayerische Motoren Werke
Aktiengesellschaft
Munich, Germany
Reprinting, including excerpts, only with the
written consent of BMW AG, Munich.
US English II/10, 08 03 450
Printed on environmentally friendly paper,
bleached without chlorine, suitable for recycling.

CONTENTS

The fastest way to find information on a particular topic or item is by using the index, refer to page 200.

Using this Owner's Manual

- 4 Notes
- 6 Reporting safety defects

AT A GLANCE

- 10 Cockpit
- 16 Onboard monitor
- 21 Voice activation system

CONTROLS

- 26 Opening and closing
- 37 Adjustments
- 43 Transporting children safely
- 46 Driving
- 55 Controls overview
- 70 Technology for driving comfort and safety
- 81 Lamps
- 85 Climate
- 88 Practical interior accessories

DRIVING TIPS

- 96 Things to remember when driving

NAVIGATION

- 106 Starting the navigation system
- 108 Destination entry
- 120 Destination guidance
- 128 What to do if ...

ENTERTAINMENT

- 132 On/off and settings
- 135 Radio
- 143 CD player and CD changer
- 149 AUX-IN port
- 150 USB audio interface

MOBILITY

- 156 Refueling
- 158 Wheels and tires
- 167 Under the hood
- 170 Maintenance
- 172 Care
- 176 Replacing components
- 186 Giving and receiving assistance

REFERENCE

- 192 Technical data
- 195 Short commands for the voice activation system
- 200 Everything from A to Z

NOTES

USING THIS OWNER'S MANUAL

We have tried to make all the information in this Owner's Manual easy to find. The fastest way to find specific topics is to refer to the detailed index at the back of the manual. If you wish to gain an initial overview of your vehicle, you will find this in the first chapter.

Should you wish to sell your MINI at some time in the future, remember to hand over this Owner's Manual to the new owner; it is an important part of the vehicle.

Additional sources of information

Should you have any other questions, your MINI dealer will be glad to advise you at any time.

You can find more information about the MINI, for example on its technology, on the Internet at www.MINI.com.

SYMBOLS USED

 Indicates precautions that must be followed precisely in order to avoid the possibility of personal injury and serious damage to the vehicle. ◀

 Indicates information that will assist you in gaining the optimum benefit from your vehicle and enable you to care more effectively for your vehicle. ◀

 Refers to measures that can be taken to help protect the environment. ◀

◀ Marks the end of a specific item of information.

* Indicates special equipment, country-specific equipment and optional accessories, as well as equipment and functions not yet available at the time of printing.

"..." Identifies Control Display texts used to select individual functions.

›...◀ Verbal instructions to use with the voice activation system.

››...◀◀ Identifies the answers generated by the voice activation system.

Symbols on vehicle components

 Indicates that you should consult the relevant section of this Owner's Manual for information on a particular part or assembly.

THE INDIVIDUAL VEHICLE

The manufacturer of your MINI is the Bayerische Motoren Werke Aktiengesellschaft, BMW AG.

When you ordered your MINI, you chose various items of equipment. This Owner's Manual describes the entire array of options and equipment that the manufacturer of your MINI makes available with a specific model range.

Bear in mind that the manual may contain information on accessories and equipment that you have not specified for your own vehicle. Sections describing options and special equipment are marked by asterisks * to assist you in identifying possible differences between the descriptions in this manual and your own vehicle's equipment.

If your MINI features equipment not described in this Owner's Manual, observe the enclosed Supplementary Owner's Manuals.

EDITORIAL NOTICE

The manufacturer pursues a policy of continuous, ongoing development that is conceived to ensure that MINI vehicles continue to embody the highest quality and safety standards combined with advanced, state-of-the-art technology. For this reason, it is possible in exceptional cases that features described in this Owner's Manual could differ from those on your vehicle.

FOR YOUR SAFETY

Maintenance and repair

 Advanced technology, e.g. the use of modern materials and powerful electronics, requires specially adapted maintenance and repair methods. Therefore, have the necessary work on your MINI only carried out by a MINI dealer or a workshop that has specially trained personnel working in accordance with the specifications of the MINI manufacturer. If this work is not carried out properly, there is a danger of subsequent damage and related safety hazards. ◀

Parts and accessories

 For your own safety, use genuine parts and accessories approved by the manufacturer of the MINI.

When you purchase accessories tested and approved by the manufacturer of the MINI and Original MINI Parts, you simultaneously acquire the assurance that they have been thoroughly tested by the manufacturer of the MINI to ensure optimum performance when installed on your vehicle.

The manufacturer of the MINI warrants these parts to be free from defects in material and workmanship.

The manufacturer of the MINI will not accept any liability for damage resulting from installation of parts and accessories not approved by the manufacturer of the MINI.

The manufacturer of the MINI cannot test every product made by other manufacturers to verify if it can be used on a MINI safely and without risk to either the vehicle, its operation, or its occupants.

Original MINI Parts, MINI Accessories and other products approved by the manufacturer of the MINI, together with professional advice on using these items, are available from all MINI dealers.

Installation and operation of accessories that have not been approved by the manufacturer of your MINI, such as alarms, radios, amplifiers, radar detectors, wheels, suspension compo-

nents, brake dust shields, telephones, including operation of any mobile phone from within the vehicle without using an externally mounted antenna, or transceiver equipment, for instance, CBs, walkie-talkies, ham radios or similar accessories, may cause extensive damage to the vehicle, compromise its safety, interfere with the vehicle's electrical system or affect the validity of the MINI Limited Warranty. See your MINI dealer for additional information. ◀

 Maintenance, replacement, or repair of the emission control devices and systems may be performed by any automotive repair establishment or individual using any certified automotive part. ◀

California Proposition 65 warning

California law requires us to issue the following warning:

 Engine exhaust and a wide variety of automobile components and parts, including components found in the interior furnishings in a vehicle, contain or emit chemicals known to the State of California to cause cancer and birth defects and reproductive harm. In addition, certain fluids contained in vehicles and certain products of component wear contain or emit chemicals known to the State of California to cause cancer and birth defects or other reproductive harm.

Battery posts, terminals and related accessories contain lead and lead compounds. Wash your hands after handling.

Used engine oil contains chemicals that have caused cancer in laboratory animals. Always protect your skin by washing thoroughly with soap and water. ◀

SERVICE AND WARRANTY

We recommend that you read this publication thoroughly.

Your MINI is covered by the following warranties:

- ▷ New Vehicle Limited Warranty
- ▷ Rust Perforation Limited Warranty

- ▷ Federal Emissions System Defect Warranty
- ▷ Federal Emissions Performance Warranty
- ▷ California Emission Control System Limited Warranty

Detailed information about these warranties is listed in the Service and Warranty Information Booklet for US models or in the Warranty and Service Guide Booklet for Canadian models.

Your vehicle has been specifically adapted and designed to meet the particular operating conditions and registration requirements in your country and continental region in order to deliver the full driving pleasure while the vehicle is operated under those conditions. If you wish to operate your vehicle in another country or region, you may be required to adapt your vehicle to meet different prevailing operating conditions and registration requirements. You should also be aware of any applicable warranty limitations or exclusions for such country or region. In such a case, please contact Customer Relations for further information.

REPORTING SAFETY DEFECTS

For US customers

The following applies only to vehicles owned and operated in the US.

If you believe that your vehicle has a defect that could cause a crash or could cause injury or death, you should immediately inform the National Highway Traffic Safety Administration, NHTSA, in addition to notifying MINI of North America, LLC, P.O. Box 1227, Westwood, New Jersey 07675-1227, Telephone 1-800-831-1117.

If NHTSA receives similar complaints, it may open an investigation, and if it finds that a safety defect exists in a group of vehicles, it may order a recall and remedy campaign. However, NHTSA cannot become involved in individual problems between you, your dealer, or MINI of North America, LLC.

To contact NHTSA, you may call the Vehicle Safety Hotline toll-free at 1-888-327-4236 (TTY: 1-800-424-9153); go to <http://www.safercar.gov>; or write to: Administrator, NHTSA, 400 Seventh Street, SW., Washington, DC 20590. You can also obtain other information about motor vehicle safety from <http://www.safercar.gov>

For Canadian customers

Canadian customers who wish to report a safety-related defect to Transport Canada, Defect Investigations and Recalls, may call 1-800-333-0510 toll-free from anywhere in Canada or 1-613-993-9851 from the Ottawa region and from other countries, or contact Transport Canada by mail at: transport Canada, ASFAD, Place de Ville, Tower C, 330 Sparks Street, Ottawa, ON, K1A 0N5.

You can also obtain other information about motor vehicle safety from <http://www.tc.gc.ca>



AT A GLANCE

CONTROLS

DRIVING TIPS

NAVIGATION

ENTERTAINMENT

MOBILITY

REFERENCE

COCKPIT

AROUND THE STEERING WHEEL: CONTROLS AND DISPLAYS

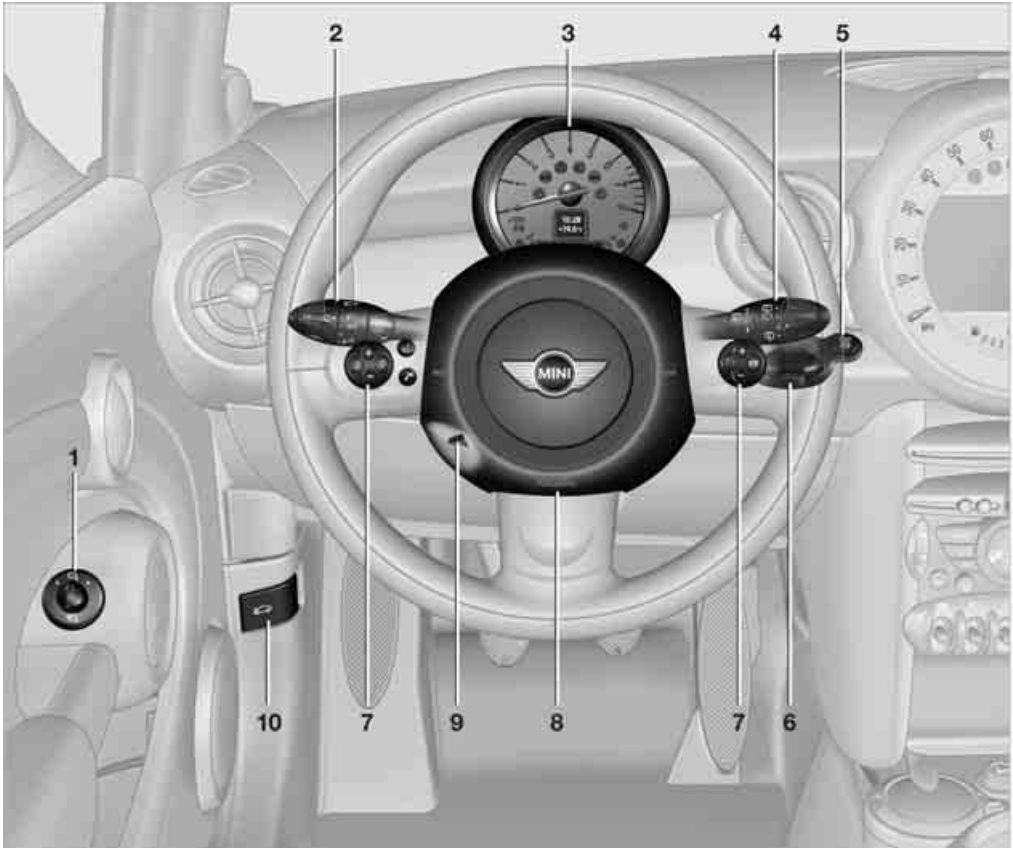



1 Adjusting the exterior mirrors, folding them in and out* 41

2  Parking lamps 81

 Low beams 81

 Automatic headlamp control* 81

 Turn signals 50

 High beams 82
 Headlamp flasher 50

 Roadside parking lamps* 82

 Computer* 56

3 Tachometer 12



Instrument lighting 83



Resetting the trip odometer 55

4  Wiper system 51

5  Switching the ignition on/off and starting/stopping the engine 46

6 Ignition lock 46

7 Buttons* on steering wheel



Continuing cruise control* 53



Right:
Storing speed and accelerating or decelerating



Left:
Increase or reduce volume



Activating/deactivating cruise control* 53



Telephone*:

- ▷ Press: accepting and ending a call, starting dialing* of selected phone number and redialing if no phone number is selected
- ▷ Press longer: redialing



Activating/deactivating voice activation system* 21



Changing radio station
Selecting music track



Scrolling through phone book and lists with stored phone numbers

8 Horn: the entire surface

9 Adjusting the steering wheel 41

10 Releasing the hood 167

DISPLAYS

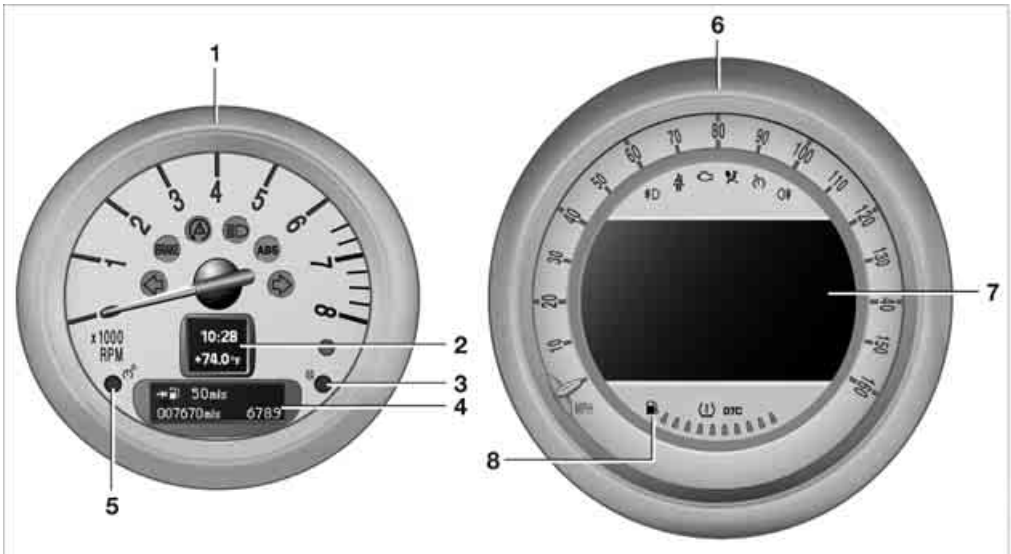

000001-000001

- 1 Tachometer 55
with indicator and warning lamps 13
- 2 Display for
 - ▷ Clock 55
 - ▷ Outside temperature 55
 - ▷ Current vehicle speed 55
 - ▷ Indicator and warning lamps 13
- 3 Resetting the trip odometer 55
- 4 Display for
 - ▷ Position of automatic transmission* 48
 - ▷ Computer* 56
 - ▷ Date of next scheduled service, and remaining distance to be driven 60
 - ▷ Odometer and trip odometer 55
 - ▷ Initializing the Flat Tire Monitor* 74
 - ▷ Resetting the Tire Pressure Monitor* 76
 - ▷ Settings and information 59
 - ▷ Personal Profile settings 26
- 5 Instrument lighting 83
- 6 Speedometer
with indicator and warning lamps 13
- 7 Control Display 16
- 8 Fuel gauge 56

INDICATOR AND WARNING LAMPS

The concept

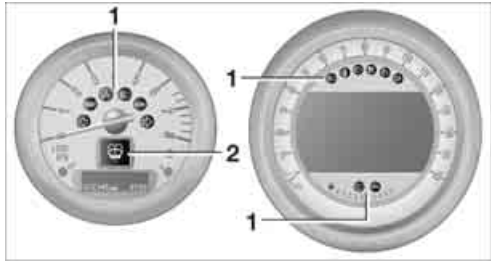

Indicator and warning lamps can light up in various combinations and colors in indicator area 1 or 2.

Some lamps are checked for proper functioning and thus come on briefly when the engine is started or the ignition is switched on.

Explanatory text messages



Text messages at the lower edge of the Control Display explain the meaning of the displayed indicator and warning lamps.

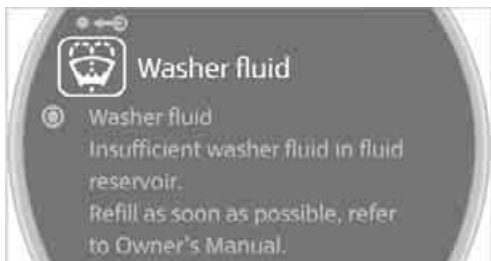









You can call up more information, e.g. on the cause of a malfunction and on how to respond, via Check Control, page 65.

In urgent cases, this information will be shown as soon as the corresponding lamp comes on.

Indicator lamps without text messages







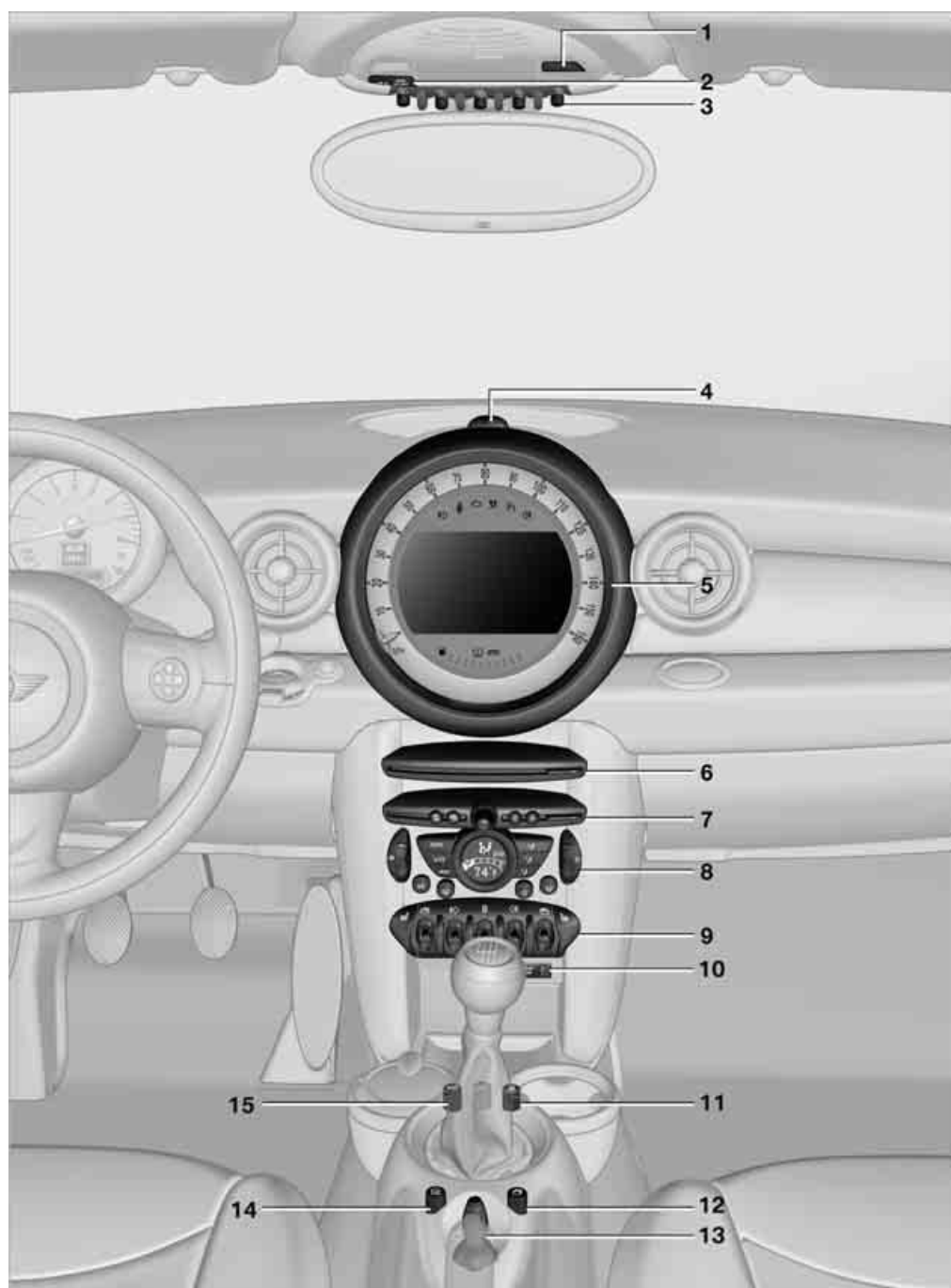





The following indicator lamps in display area 1 indicate certain functions:









-  High beams/headlamp flasher 82
-  Fog lamps* 83
-  Rear fog lamp* 83
-  Lamp flashes:
DSC or DTC is regulating the drive forces in order to maintain driving stability 71
-  Parking brake applied 47
-  Engine malfunction with adverse effect on exhaust emissions 171
-  Cruise control 53
-  Turn signals 50

AROUND THE CENTER CONSOLE



www.ford.com

- 1 Microphone for voice activation system* and for telephone in hands-free mode* 80
- 2 Indicator/warning lamp* for front passenger airbags 80
- 3  Reading lamps* 84
-  Color of ambient lighting* 84
-  Glass sunroof, electric* 34
-  Interior lamps 83
- 4 Hazard warning flashers
- 5 Speedometer 12
- 6 Drive for audio CDs
- 7 Cover of navigation DVD drive 106
 - ▷ Switching audio sources on/off and adjusting volume
 -  Changing the radio station or track
 -  Changing the audio source
 - AM
FM Changing the frequency
- 8 Automatic climate control
 -  Temperature 86
 -  Air distribution to the windshield 86
 -  Air distribution to the upper body area 86
 -  Air distribution to the footwell 86
 - AUTO Automatic air distribution and flow rate 86
 -  Recirculated-air mode 86
 - MAX Maximum cooling 86
 -  Air flow rate 86

-  Defrosting windows 87
-  Cooling function* 87
-  Rear window defroster 87
-  Windshield heating 87
- 9 Switches in center console
 -  Seat heating* 40
 -  Power windows 35
 -  Rear fog lamp* 83
 -  Fog lamps* 83
 -  Central locking system, inside 30

- 10 AUX-IN port, USB audio interface* 149, 150
- 11 Driving stability control systems
 - ▷ Dynamic Stability Control DSC 71
 - ▷ Dynamic Traction Control DTC* 72
- 12 Changing to a different menu on the Control Display 18
- 13 MINI joystick 16
 - Move in four directions, turn or press
- 14 Opening the start menu on the Control Display 17
- 15 Sport button* 73



ONBOARD MONITOR

The onboard monitor integrates the functions of a large number of switches. This allows these functions to be operated from a single central position. The following section provides an

introduction to basic menu navigation. The control of the individual functions is described in connection with the relevant equipment.

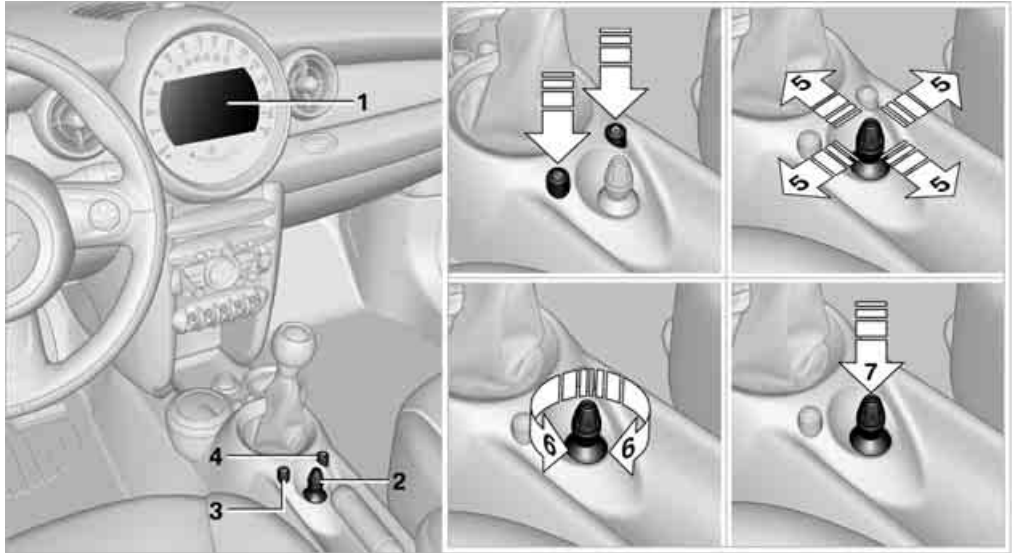
CONTROLS



- 1 Control Display 16
- 2 MINI joystick
The MINI joystick can be used to select menu items and to adjust settings:
 - ▷ Move in four directions, arrows 5
 - ▷ Turn, arrow 6
 - ▷ Push, arrow 7
- 3  Opening start menu 17
- 4  Changing to another menu 18

 Operate the MINI joystick only when traffic and road conditions allow this, to avoid endangering the car's occupants and other road users by being distracted. ◀

MENU OVERVIEW

Navigation

- ▷ Navigation system
- ▷ Onboard information, e.g. for displaying the average fuel consumption

Communication*

- ▷ Telephone, refer to separate Owner's Manual

Entertainment

- ▷ Radio
- ▷ CD player and CD changer*
- ▷ AUX-IN port, USB audio interface* for external audio device

Setup

- ▷ Switching off Control Display
- ▷ Tone and display settings
- ▷ Settings for your vehicle, e.g. for the central locking system
- ▷ Display of service requirements and dates for statutory emissions and vehicle inspections
- ▷ Check Control

To access the start menu from the Setup menu:
Press the  button twice.

Calling up menu items in the start menu

Via the start menu you can call up the four menu items of Navigation, Communication, Entertainment and Setup: move the MINI joystick forward or backward or press it. Depending on the selection, the menu last opened is displayed.

OPERATING PRINCIPLE

As of radio readiness, the following message appears on the Control Display:



To hide the message:

Press the MINI joystick.

The start menu is displayed.

The message is automatically hidden after approx. 10 seconds.

Start menu



All onboard monitor functions can be called up via four menu items.

Opening start menu

Press the  button.

Changing between menu items

Press the  button.

Pressing the button repeatedly opens the Communication, Navigation and Entertainment menu items in succession. The screen that was last open is displayed.

Displays in menu

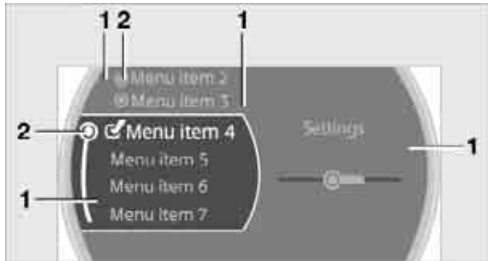

- 1 Each menu is subdivided into fields.
- 2 White symbol: the field is active.
Gray symbol: the field is inactive.

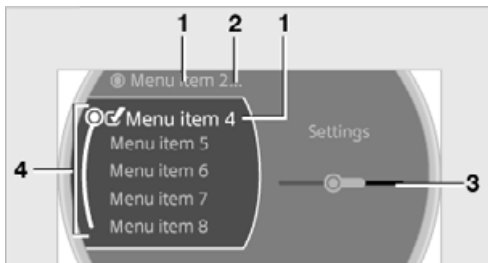

- 1 Menu items are usually grouped in horizontal or vertical lists.
- 2 Additional menu items can be selected in this field.
- 3 Settings are represented graphically or as numerical values.
- 4 A curved line shows that menu items can be selected in lists. The beginning and end of a list are each marked by a circle.

Operating principle at a glance

The following is a general description of operations using the onboard monitor.

For an exemplary step-by-step application, refer to Setting the time, page 63.

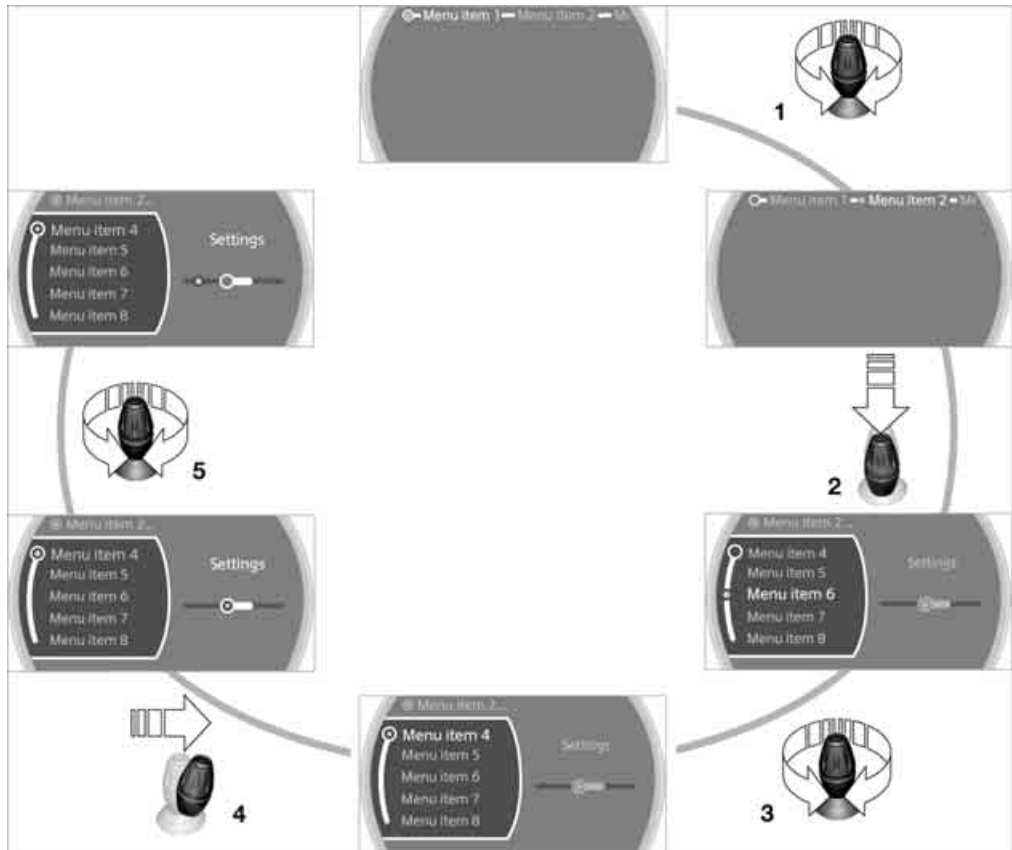

- 1 Highlighting a menu item:**
 - ▶ Turn the MINI joystick; the highlight marker moves
 - ▶ Menu items that are displayed in color on the Control Display can be highlighted
- 2 Confirming a menu item:**
 - ▶ Press the MINI joystick
 - ▶ New menu items are displayed or the function is executed
 - ▶ Select a function by highlighting and confirming it
- 3 Highlighting a menu item: refer to 1**
- 4 Switching between fields:**
 - ▶ Briefly move the MINI joystick to the left, right, forward or backward
 - ▶ Release the MINI joystick
- 5 Adjusting settings:**
 - ▶ Turn the MINI joystick
 - ▶ Graphic display, numerical value or text displays can be changed
 - ▶ Confirm by switching to another field

STATUS INFORMATION



- 1 Display for:
 - ▷ Entertainment: Radio, CD and external audio source* or
 - ▷ Telephone* in "Communication": Name of the connected mobile phone, network search or no network
- 2 Entertainment audio output off or display for traffic information*:
 - ▷ "TI": Traffic information reception for the navigation system is possible and switched on
- 3 Display for:
 - ▷ new entries present in "Missed calls"*
 - ▷ Roaming active
- 4 It is possible to make calls* if the mobile phone is paired with the vehicle
 Reception strength of mobile phone network, depending on mobile phone
- 5 Time

Other displays:

Status information is temporarily hidden during Check Control message displays or entries via the voice activation system*.

SWITCHING CONTROL DISPLAY OFF/ON

1. Press the button.
This opens the start menu.
2. Move the MINI joystick to highlight "Setup" and press the MINI joystick.
3. Select "Display off".



To switch on, press the MINI joystick.

VOICE ACTIVATION SYSTEM*

THE CONCEPT

The voice activation system allows you to control operation of various vehicle systems without removing your hands from the steering wheel.

Individual menu items on the Control Display can be spoken as commands. It is not necessary to use the MINI joystick.

The voice activation system transforms oral commands into control signals for the selected systems and provides support in the form of instructions or questions.

Precondition

Via the onboard monitor, select the language in which the voice activation system is operating, so that the spoken commands can be identified. Setting the onboard monitor language, page 68.

Symbols in the Owner's Manual

- ›...‹ Say the specified commands word for word.
- ››...‹‹ Indicates responses of the voice activation system.

SAYING COMMANDS

Activating voice activation system

1. Press the  button on the steering wheel.





 This symbol on the Control Display and an acoustic signal indicate that the voice activa-

tion system is ready to receive spoken commands.



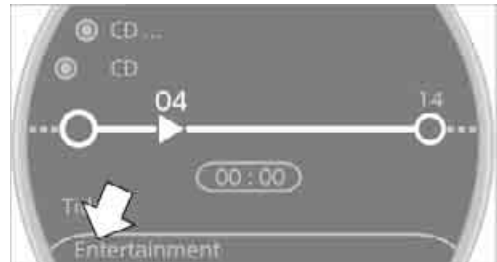

2. Say the command.
The command appears on the Control Display.



 This symbol is displayed on the Control Display when you can enter additional commands. If no further commands are possible, continue by operating the item of equipment via the onboard monitor.

Terminating or canceling voice activation system

Press the  button on the steering wheel or

 ›Cancel‹

Commands

Having the possible commands read aloud

You can have the system read aloud the possible commands related to the selected menu item on the Control Display.

Having the possible commands read aloud:

›Options◀

For example, if you have selected "CD", the system will read aloud the possible commands for operating the CD player and CD changer.

Opening help

›Help◀

Using alternative commands

There are often a number of commands to run a function, e.g.:

›Radio on◀ or ›Turn radio on◀

Calling up functions immediately via short commands

Short commands enable you to perform certain functions immediately, irrespective of which menu item is selected, page 195.

Opening the start menu

›Main menu◀

Example: selecting a track

1. Press the  button on the steering wheel.

2. ›Entertainment◀
The system says:
››Entertainment◀◀

3. ›CD◀
The system says:
››CD on◀◀



4. Press the  button on the steering wheel.

5. Select a track, e.g.:
›Track 1◀
The system says:
››Track 1◀◀



NOTES

 For information on voice commands for the telephone, refer also to the separate Owner's Manual. ◀

For voice commands, bear in mind the following:

- ▷ Pronounce the commands and digits smoothly and at normal volume, avoiding excessive emphases and pauses. The same applies to spelling when entering a destination for navigation.
- ▷ Always speak the commands in the language of the voice activation system.
- ▷ When selecting a radio station, use the standard pronunciation of the station name.
- ▷ Keep the doors, windows and glass roof* closed to prevent interference from outside noise.
- ▷ Avoid ambient noise in the vehicle while speaking.



AT A GLANCE

CONTROLS

DRIVING TIPS

NAVIGATION

ENTERTAINMENT

MOBILITY

REFERENCE

OPENING AND CLOSING

KEYS/REMOTE CONTROLS



Remote control

Each remote control contains a rechargeable battery that is recharged when it is in the ignition lock while the car is being driven. You should therefore use each remote control at least twice a year to maintain the charge status. In vehicles equipped with Comfort Access*, the remote control contains a replaceable battery, page 34.

If more than one remote control unit is used, the settings called up and implemented depend on which remote control is recognized when the car is unlocked, refer to Personal Profile, page 26.

In addition, information about service requirements is stored in the remote control, refer to Service data in the remote control, page 170.

New remote controls

Your MINI dealer can supply new remote controls as additional units or as replacements in the event of loss.

Integrated key

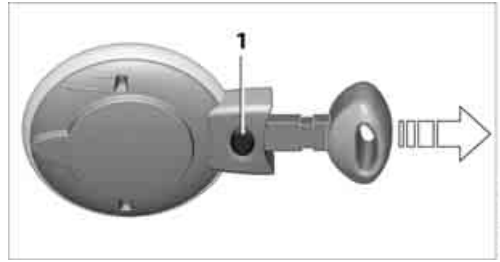

Press button 1 to release the key.

The integrated key fits the following locks:

- ▷ Driver's door, page 29.

PERSONAL PROFILE

The concept

The functions of your MINI can be set individually. By means of Personal Profiles, most of these settings are stored for the remote control currently in use. When you unlock the car, the remote control is recognized and the settings stored for it are called up and implemented.

This means that your settings will be activated for you, even if in the meantime your car was used by someone else with another remote control and the corresponding settings.

At most three remote controls can be set for three different people. A prerequisite is that each person uses a separate remote control.

Personal Profile settings

For more information on specific settings, refer to the specified pages.

- ▷ Response of the central locking system when the car is being unlocked 27
- ▷ Automatic locking of the vehicle 30
- ▷ Triple turn signal activation 50

- ▷ Settings for the displays on the onboard monitor, in the speedometer and in the tachometer:
 - ▷ 12h/24h mode of the clock 64
 - ▷ Date format 65
 - ▷ Brightness of the Control Display 69
 - ▷ Language on the Control Display 68
 - ▷ Units of measure for fuel consumption, distance covered/remaining distances and temperature 60
- ▷ Show visual warning for Park Distance Control PDC* 70
- ▷ Light settings:
 - ▷ Pathway lighting 81
 - ▷ Daytime running lights 82
- ▷ Automatic climate control: activating/deactivating the AUTO program, setting the temperature, air volume and air distribution 86
- ▷ Entertainment:
 - ▷ Audio volume 133
 - ▷ Tone control 133
 - ▷ Speed-dependent volume control 133

CENTRAL LOCKING SYSTEM

The concept

The central locking system is ready for operation whenever the driver's door is closed.

The system simultaneously engages and releases the locks on the following:

- ▷ Doors
- ▷ Splitdoor
- ▷ Fuel filler flap

Operating from outside

- ▷ Via the remote control
- ▷ Via the door lock*
- ▷ In cars with Comfort Access*, via the door handles on the driver's and passenger's sides.

The anti-theft system is also operated at the same time. It prevents the doors from being unlocked using the lock buttons or door handles. The remote control can also be used to switch on/off the welcome lamps and interior lamps. The alarm system* is also activated or deactivated, page 31.

Operating from inside

Button for central locking system, page 30.

In the event of a sufficiently severe accident, the central locking system unlocks automatically. In addition, the hazard warning flashers and interior lamps come on.

OPENING AND CLOSING: FROM OUTSIDE



Persons or animals in a parked vehicle could lock the doors from the inside. Take the key with you when you leave the vehicle so that the vehicle can be opened from the outside. ◀

Using the remote control

Unlocking

Press the  button.

The welcome lamps and interior lamps come on.

Unlocking mode

You can also set which parts of the car are unlocked. The setting is stored for the remote control in use.

Onboard monitor, for operating principle refer to page 16.

1. Press the  button. This opens the start menu.
2. Move the MINI joystick to highlight "Setup" and press the MINI joystick.

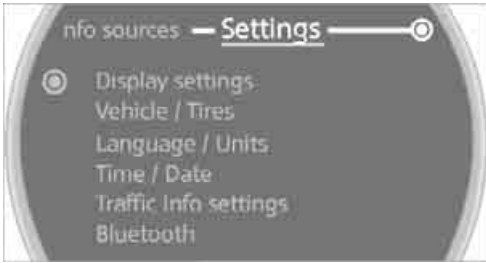

3. Select "Settings".



4. Select "Vehicle and tires".
5. Select "Door locks".



6. Select "Central locking".
7. Select "Unlock button".
8. Select a menu item:

- ▷ All doors
Press the  button once to unlock the entire vehicle.
- ▷ Driver's door
Press the  button once to unlock only the driver's door and the fuel filler flap*.
Press the button twice to unlock the entire vehicle.



Convenient opening

Hold the  button down.

The power windows are opened and the glass sunroof* is raised.

 Convenient closing is not possible by means of the remote control. ◀

Locking

Press the  button.

 Do not lock the vehicle from the outside if there is any person inside, because the vehicle cannot be unlocked from inside without special knowledge. ◀

Setting confirmation signals

To have the vehicle confirm when it has been locked or unlocked.

▷ **off**

The function is deactivated.

1. Press the  button.
This opens the start menu.
2. Move the MINI joystick to highlight "Setup" and press the MINI joystick.
3. Select "Settings".
4. Select "Vehicle and tires".
5. Select "Door locks".
6. Select "Confirmation".



7. Select the desired signal.

The signal is activated.

Acoustic signals can be selected in vehicles with an alarm system.

Switching on interior lamps

While the car is locked:

Press the  button.

You can also use this function to locate your vehicle in parking garages, etc.

Unlocking the splitdoor

Press the  button.

 When it is opened, the splitdoor swings upward and outward to the rear. Make sure that adequate clearance is available before opening.

To prevent accidentally locking yourself out, do not place the key down in the cargo bay. If the splitdoor was locked before opening, it will be locked again after it is closed.

Before and after each trip, check that the splitdoor has not been inadvertently unlocked. ◀

Malfunctions

The remote control may malfunction due to local radio waves. If this occurs, unlock and lock the car at the door lock with the integrated key.

If the car can no longer be locked with a remote control, the battery in the remote control is discharged. Use this remote control during an extended drive; this will recharge the battery, page 26.

For US owners only

The transmitter and receiver units comply with part 15 of the FCC/Federal Communications Commission regulations. Operation is governed by the following:

FCC ID:
LX8766S
LX8766E
LX8CAS

Compliance statement:

This device complies with part 15 of the FCC Rules. Operation is subject to the following two conditions:

- ▶ This device must not cause harmful interference, and
- ▶ this device must accept any interference received, including interference that may cause undesired operation.

 Any unauthorized modifications or changes to these devices could void the user's authority to operate this equipment. ◀

Using the door lock

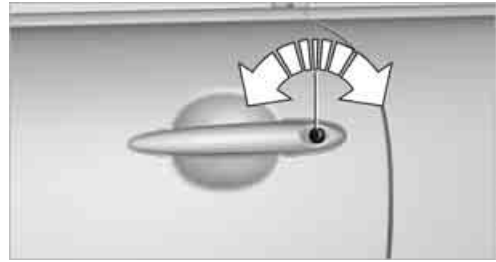

You can set which parts of the car are unlocked, page 27.

 When there is no alarm system* or Comfort Access*, only the driver's door is locked with the door lock. ◀

To lock all doors, the fuel filler flap and splitdoor together:

With the doors closed, press the interior central locking button, page 30 to lock the vehicle.

Unlocking and opening the driver or passenger door, page 30.

Locking the vehicle.

- ▶ Lock the driver's door with the integrated key via the door lock, or
- ▶ press the safety lock button on the passenger's door and close the door from the outside.

Convenient operation

With an alarm system* or Comfort Access*, the windows and glass sunroof* can be operated via the door lock.

Opening/closing

Hold the key in the position for unlocking or locking.

 Watch during the closing process to be sure that no one is injured. Releasing the key stops the operation. ◀

Manual operation

In the event of an electrical malfunction, the driver's door can be unlocked or locked by turning the integrated key in the door lock to the end positions.

OPENING AND CLOSING: FROM INSIDE

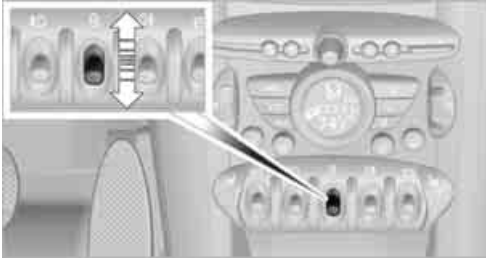

The switch locks or unlocks the doors and split-door when the doors are closed, but the anti-theft system is not activated. The fuel filler flap remains unlocked*.

Unlocking and opening

- ▷ Either unlock the doors together using the switch for the central locking system and then pull the door handle above the armrest or
- ▷ pull on the door handle of either door twice: The first time unlocks the door, the second time opens it.

Locking

- ▷ Press the switch or
- ▷ press down the safety lock button of a door. To prevent you from being locked out, the open driver's door cannot be locked using the lock button.

 Persons or animals in a parked vehicle could lock the doors from the inside. Take the key with you when you leave the vehicle so that the vehicle can be opened from the outside. ◀

Automatic locking

You can also set the situations in which the car locks. The setting is stored for the remote control in use.

1. Press the  button. This opens the start menu.
2. Move the MINI joystick to highlight "Setup" and press the MINI joystick.
3. Select "Settings".
4. Select "Vehicle and tires".
5. Select "Door locks".
6. Select "Central locking".



7. Select a menu item:
 - ▷ Relock if not opened
The central locking system automatically locks the vehicle after a short time if no door has been opened.
 - ▷ Lock after driving
The central locking system automatically locks the vehicle as soon as you begin to drive.
- The setting is selected.

The setting is stored for the remote control currently in use.

CLUBDOOR

Opening

The Clubdoor can only be opened using the handle on the inside. The right-hand front door must be open when opening the Clubdoor.

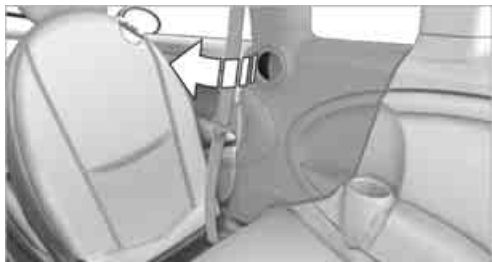

Closing

First close the Clubdoor, followed by the right-hand front door.

SPLITDOOR

▶ To avoid damage, make sure there is sufficient clearance before opening the splitdoor. ◀

Opening

▶ In some market-specific versions, the splitdoor cannot be unlocked using the remote control unless the vehicle is unlocked first.

Only drive with the splitdoor fully closed; otherwise, the tail lamps will be obscured and driving safety will be compromised. ◀



Press the button in the handle or the  button of the remote control for an extended time. The splitdoor is unlocked.

Using the button in the handle, fully open first the right side, arrow 1, and then the left side of the splitdoor, arrow 2.

Closing

⚠ Make sure that the closing path of the splitdoor is clear; otherwise, injuries may occur. ◀

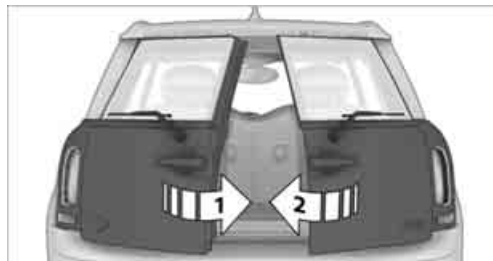

Close the left side, arrow 1, and then the right side of the splitdoor, arrow 2.

ALARM SYSTEM*

The concept

The alarm system, when activated, reacts if:

- ▶ A door, the engine compartment lid or the liftgate is opened
- ▶ There is movement inside the car
- ▶ The car's inclination changes, for instance if an attempt is made to jack it up and steal the wheels or to raise it prior to towing away
- ▶ There is an interruption in the power supply from the battery

The alarm system briefly indicates unauthorized entry or tampering by means of:

- ▶ An acoustic alarm
- ▶ Switching on the hazard warning flashers

Arming and disarming

Whenever the car is locked or unlocked, the alarm system is armed or disarmed.

Even when the alarm system is armed, you can open the liftgate by means of the  button on the remote control.

When you subsequently close the liftgate it is again locked and monitored.

 In certain market-specific versions, unlocking via the door lock triggers the alarm. ◀

Panic mode*

You can activate the alarm system if you find yourself in a dangerous situation.

Press the  button for at least two seconds.

Switching off the alarm:

Press any button.

Switching off an alarm

- ▷ Unlock the car with the remote control.
- ▷ Insert the key fully into the ignition lock.
- ▷ In cars with Comfort Access*, press the button on the door lock.

Display on the revolution counter

When the system is armed, all LEDs pulse. After approx. 16 minutes one LED flashes.

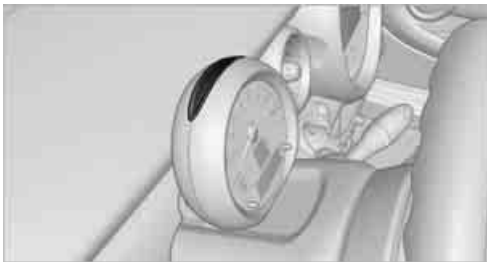

- ▷ LEDs pulse or LED flashes: system is armed.
- ▷ One LED flashes at short intervals:
A door, the hood or the liftgate is not properly closed. Even if these are not closed fully, the remaining items are deadlocked and the LEDs pulse after approx. 10 seconds for approx. 16 minutes. Afterwards, one LED flashes.

The interior movement detector is not activated.

- ▷ LEDs go out after the vehicle is unlocked: No attempt was made to tamper with the car.
- ▷ LEDs flash after unlocking until the key is inserted in the ignition, but for no longer than approx. 5 minutes: an attempt was made to tamper with the car.

Tilt alarm sensor

The vehicle's inclination is monitored. The alarm is triggered, for instance, if an attempt is made to steal the car's wheels or tow it away.

Interior movement detector

Before the interior movement detector can operate correctly, the windows and glass roof must be closed.

Avoiding false alarms

The tilt alarm sensor and the interior movement detector can be switched off together.

This prevents false alarms, e.g. in the following situations:

- ▷ In duplex garages
- ▷ When being transported on car-carrying trains, ferries or trailers
- ▷ If pets are to remain inside the car

Switching off the tilt alarm sensor and interior movement detector

- ▷ Press the  button on the remote control twice in succession.
- ▷ Lock the vehicle twice with the integrated key.

LEDs flash in short succession for approx. 2 seconds.

The tilt alarm sensor and the interior movement detector are switched off until the car is next unlocked and locked.

COMFORT ACCESS*

Comfort Access enables you to enter your vehicle without having to hold the remote control in your hand. All you need to do is wear the remote control close to your body, e.g. in your jacket pocket. The vehicle automatically detects the remote control within the immediate vicinity or in the passenger compartment.

Functional requirements

- ▷ The vehicle or the splitdoor can only be locked when the vehicle detects that the remote control currently in use is outside of the vehicle.
- ▷ The vehicle cannot be locked or unlocked again until after approx. 2 seconds.
- ▷ The engine can only be started when the vehicle detects that the remote control is inside the vehicle.
- ▷ The doors and splitdoor must be closed to be able to operate the windows and glass sunroof*.

Comfort Access supports the following functions:

- ▷ Unlocking/locking the vehicle
- ▷ Unlocking the splitdoor by itself
- ▷ Starting the engine

Comparison to standard remote controls

Essentially, it makes no difference whether you control the above-mentioned functions using Comfort Access or by pressing the buttons on the remote control for Comfort Access.

Instructions on opening and closing are found starting on page 26.

Special features regarding the use of Comfort Access are described below.

 If you notice a brief delay while opening or closing the windows or glass sunroof, the system is checking whether a remote control is inside the vehicle. Repeat the opening or closing procedure, if necessary. ◀

To unlock

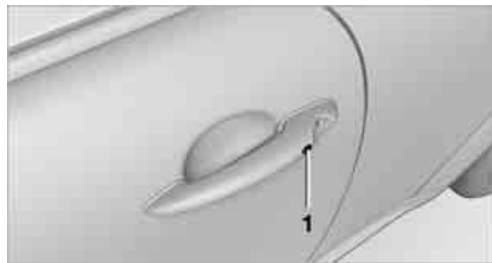

Press button 1.

Depending on the setting, refer to Unlocking mode on page 27, only the driver's door or the entire vehicle is unlocked.

 Press the button again to lock the vehicle again. ◀

Convenient opening with the remote control, refer to page 28.

Locking

Press button 1.

Unlocking the splitdoor separately

Press the button on the outside of the splitdoor.

 If the vehicle detects that a remote control has been accidentally left inside the locked vehicle's cargo bay after the splitdoor is closed, the splitdoor will reopen slightly. The hazard warning flashers flash and an acoustic signal* sounds. ◀

Windows and glass sunroof, electric*

If the engine is switched off, you can still operate the windows and glass sunroof so long as a door or the splitdoor has not been opened.

If the doors and splitdoor are closed again and the remote control is located inside the vehicle, the windows and the glass sunroof can be operated again.

Insert the remote control into the ignition lock to be able to operate the windows or glass sunroof when the engine is switched off and the doors are open.

Switching on radio readiness

Switch on radio readiness by briefly pressing the start/stop button, page 46.

 Do not depress the brake or the clutch; otherwise, the engine will start. ◀

Starting the engine

The engine can be started or the ignition can be switched on when a remote control is inside the vehicle. It is not necessary to insert a remote control into the ignition lock, page 46.

Switching off the engine in cars with automatic transmission

The engine can only be switched off when the selector lever is in position P, page 47. To switch the engine off when the selector lever is in position N, the remote control must be in the ignition lock.

Before driving a vehicle with automatic transmission into a car wash

1. Insert remote control into ignition lock.
2. Depress the brake.
3. Move the selector lever to position N.
4. Switch off the engine.

The vehicle can roll.

Malfunction

Comfort Access may malfunction due to local radio waves.

If this happens, open or close the vehicle via the buttons on the remote control or using the integrated key.

Insert the remote control into the ignition lock and start the engine.

Warning lamps

 The warning lamp comes on when an attempt is made to start the engine: the engine cannot be started. The remote control is not inside the vehicle or is malfunctioning. Take the remote control with you inside the vehicle or have it checked. If necessary,

insert another remote control into the ignition lock.



The warning lamp comes on when the engine is running: the remote control is no longer inside the vehicle. After the engine is switched off, the engine can only be restarted within approx. 10 seconds.



The indicator lamp comes on and a message appears on the Control Display: Replace the battery in the remote control.

Replacing the battery

The remote control for Comfort Access contains a battery that will need to be replaced from time to time.

1. Remove the cover.



2. Insert the new battery with the plus side facing up.
3. Press the cover on to close.



Take the old battery to a battery collection point or to your MINI dealer. ◀

GLASS SUNROOF, ELECTRIC*



To prevent injuries, exercise care when closing the glass sunroof and keep it in your field of vision until it is shut. Take the key with you when you leave the car; otherwise, children could operate the sunroof and possibly injure themselves. ◀

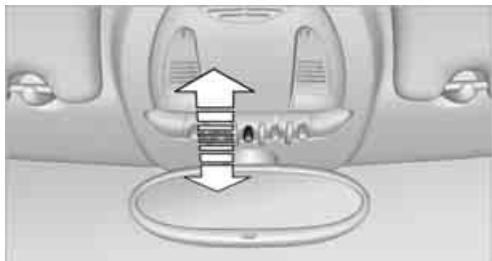

Raising

- ▷ Press the switch backward to the resistance point and hold it there. Both glass sunroofs are raised. Releasing the switch stops the movement.
- ▷ With the ignition switched on, press the switch backward beyond the resistance point. Both closed sunroofs are raised fully. Pressing again stops the movement.

Opening, closing

With the ignition switched on and the glass sunroof raised, press the switch backward and hold it there.

The front glass sunroof opens.

The rear glass sunroof is closed.

Releasing the switch stops the movement.

The glass sunroof can be closed in the same way by pressing the switch forward.

The front glass sunroof remains in a raised position. The rear glass sunroof is raised. Pressing on the switch again closes both sunroofs completely.

Convenient operation via door lock or Comfort Access, refer to page [28](#), [29](#), [33](#).

Roller sun blind

The roller sun blind can be opened and closed independently of the glass sunroof.

Following interruptions in electrical power supply

After a power failure, there is a possibility that the glass sunroof can only be raised. In this case, have the system initialized. The manufacturer of

your MINI recommends that you have this work done by your MINI dealer.

WINDOWS

 To prevent injuries, exercise care when closing the windows.

Take the remote control with you when you leave the car; otherwise, children could operate the electric windows and possibly injure themselves. ◀

 If, after a window is opened and closed several times in close succession, the window can only be closed and not opened, the system is overheated. Let the system cool for several minutes with the ignition switched on or the engine running. ◀

Opening, closing

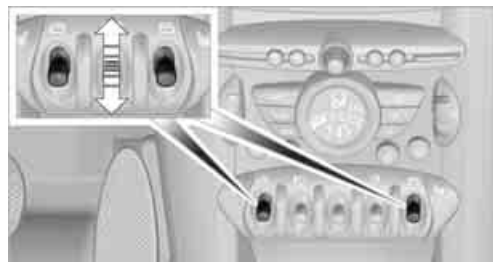

- ▷ Press the switch downwards. The window opens until you release the switch.
- ▷ Tap the switch downwards. As soon as the remote is ready, the windows will open automatically. Tap the switch again to stop the opening movement.

The window can be closed in the same way by pressing the switch up.

After switching off the ignition

When the ignition is switched off, the windows can still be operated for approx. 1 minute as long as no door is opened.

 Take the key with you when you leave the car; otherwise, children could operate the electric windows and possibly injure themselves. ◀

Pinch protection system

If the closing force exceeds a specific value as a window closes, the closing action is interrupted and the window reopens slightly.



Even though there is the pinch protection system, always ensure that the window's travel path is clear; otherwise, the safety system might fail to detect certain kinds of obstructions, such as thin objects, and the window would continue closing.

Do not install any accessories that might interfere with window movement. Otherwise, the pinch protection system could be impaired. ◀

Closing without pinch protection

If there is an external danger, or if ice on the windows, etc., prevents you from closing the windows normally, the window can be closed manually.

1. Press the switch upward and hold it there. Pinch protection is limited and the window reopens slightly if the closing force exceeds a certain value.
2. Press the switch upward again within approx. 4 seconds and hold it there. The window closes without pinch protection.

ADJUSTMENTS

SITTING SAFELY

The ideal sitting position can make a vital contribution to relaxed, fatigue-free driving. In conjunction with the safety belts, the head restraints and the airbags, the seated position has a major influence on your safety in the event of an accident. To ensure that the safety systems operate with optimal efficiency, we strongly urge you to observe the instructions contained in the following section.

For additional information on transporting children safely, refer to page 43.

Airbags

 Always maintain an adequate distance between yourself and the airbags. Always grip the steering wheel on the rim, with your hands in the 3 o'clock and 9 o'clock positions, to minimize the risk of injury to the hands or arms in the event of the airbag being triggered off. No one and nothing should come between the airbags and the seat occupant.

Do not use the cover of the front airbag on the front passenger side as a storage area. Ensure that the front passenger is correctly seated, e.g. that no feet or legs are propped against the dashboard. Otherwise, leg injury could result if the front airbag suddenly deployed.

Make sure that occupants keep their heads away from the side airbag and do not lean against the head-level airbag; otherwise injuries can occur when the airbag is triggered. ◀

Even if you follow all the instructions, injuries resulting from contact with airbags cannot be fully excluded, depending on the circumstances. The ignition and inflation noise may provoke a mild hearing loss in extremely sensitive individuals. This effect is usually only temporary.

For airbag locations and additional information on airbags, refer to page 79.

Head restraint

A correctly adjusted head restraint reduces the risk of neck injury in the event of an accident.

 Adjust the head restraint in such a way that its center is at approx. ear level. Otherwise, there is an increased risk of injury in the event of an accident. ◀

Head restraints, refer to page 39.

Safety belt

Before every drive, make sure that all occupants wear their safety belts. Airbags complement the safety belt as an additional safety device, but they do not represent a substitute.

Number of safety belts

 Never allow more than one person to wear a single safety belt. Never allow infants or small children to ride in a passenger's lap.

Make sure that the belt in the lap area sits low across the hips and does not press against the abdomen. The safety belt must not rest against the throat, run across sharp edges, pass over hard or fragile objects or be pinched. Fasten the safety belt so that it is pulled taut across the lap and shoulder, fitting the body snugly without any twists. Otherwise, the belt could slide over the hips in the event of a frontal collision and injure the abdomen. Avoid wearing bulky clothing and regularly pull the belt in the upper-body area taut; otherwise, its restraining effect could be impaired. ◀

Safety belts, refer to page 40.

SEATS

Note before adjusting

 Never attempt to adjust your seat while the vehicle is moving. The seat could respond with unexpected movement, and the ensuing loss of vehicle control could lead to an accident.

On the front passenger seat as well, do not incline the backrest too far to the rear while the vehicle is being driven; otherwise, there is a danger in the event of an accident of sliding under the safety belt, eliminating the protection normally provided by the belt. ◀

Comply with the instructions on head restraint height on page 39 and on damaged safety belts on page 40.

Seat adjustment

 Observe the instructions on page 37 to ensure the best possible personal protection. ◀



Longitudinal adjustment

Pull the lever, arrow 1, and slide the seat into the desired position, arrows 2.

After releasing the lever, move the seat slightly forward or back so that it engages properly.

Height

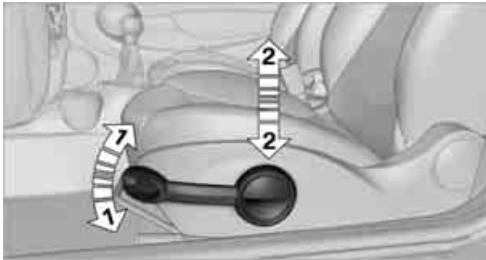

Pull up or push down the lever repeatedly, arrows 1, until the desired height is reached, arrows 2.

Backrest

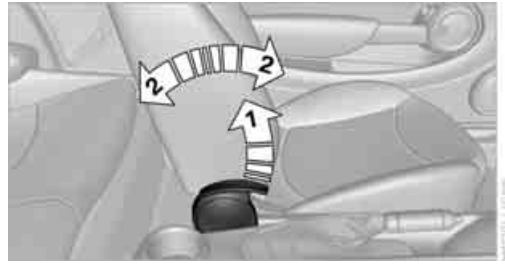

Pull the lever, arrow 1, and apply your weight to the backrest or lift it off, as necessary, arrows 2.

Lumbar support*

You can also adjust the contour of the backrest to obtain additional support in the lumbar region.

The upper hips and spinal column receive supplementary support to help you maintain a relaxed, upright sitting position.

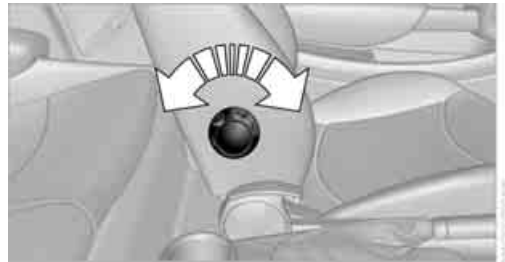

Turn the wheel to increase or decrease the curvature.

Entry to the rear

Easy entry on the driver's side

The easy entry feature includes a mechanical memory function for the longitudinal adjustment and backrest angle.

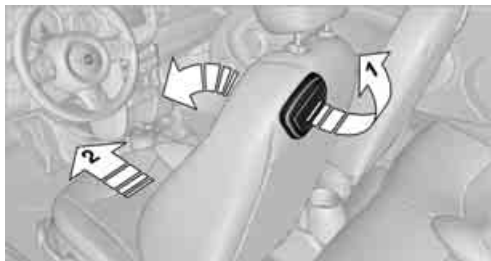

1. Pull up the lever on the seat backrest, arrow 1.
The backrest folds forward.
2. Move the seat forward by pushing on the backrest, arrow 2.

Previous position

1. Push the seat back into its previous position.

 Do not fold the backrest up until the seat is in its previous position. Otherwise, the seat will engage in its current position. In this case, adjust the longitudinal position manually, page 38. ◀

2. Fold the backrest back up to lock the seat.

 When moving the seat backwards, ensure that you do not cause personal injury or property damage.

Before driving off, engage the front seats and seat backrests. Otherwise, there is a risk of accident due to unexpected movement. ◀

HEAD RESTRAINTS

Correctly adjusted head restraint

A correctly adjusted head restraint reduces the risk of neck injury in the event of an accident.

 Correctly adjust the head restraints of all occupied seats; otherwise, there is an increased risk of injury in an accident. ◀

Height

Adjust the head restraint so that its center is approximately at ear level.

Distance

Adjust the distance so that the head restraint is as close as possible to the back of the head.

Height adjustment

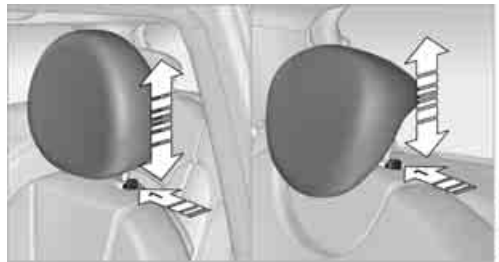

To raise: pull up.

To lower: press the button, arrow 1, and slide the head restraint down.

Removing

Only remove a head restraint if no one will be sitting on the seat in question.

 Reinstall the head restraint before transporting passengers, as otherwise the head restraint cannot provide its protective function. ◀

Front

1. Pull up as far as it will go.
2. Fold the backrest forward slightly.
3. Press button 1 and pull the head restraint out as far as it will go.
4. Fold back the backrest.

Rear

1. Pull up as far as it will go.
2. Press button 1 and pull the head restraint out completely.

SEAT HEATING*



Switching on

Press once for each temperature level. Three LEDs indicate the highest temperature.

If you continue driving within the next 15 minutes, the seat heating is automatically activated at the previously set temperature.

The temperature is lowered or the heating is switched off entirely to save on battery power. The LEDs stay lit.

Switching off

Press button longer.

SAFETY BELTS

 Observe the instructions on page 37 to ensure the best possible personal protection. ◀

Before every drive, make sure that all occupants wear their safety belts. Airbags complement the safety belt as an additional safety device, but they do not represent a substitute.

Front and rear seats

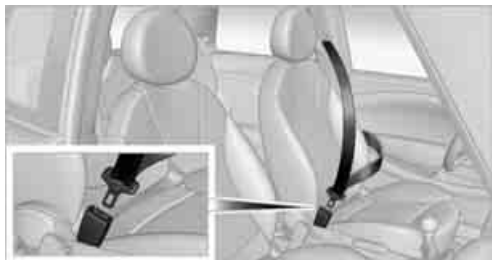

Closing

Make sure you hear the lock engage in the belt buckle.

The upper belt anchor is suitable for adults of any stature as long as the seat is adjusted properly, page 37.

Opening

1. Grasp the belt firmly.
2. Press the red button in the buckle.
3. Guide the belt into its reel.

Safety belt reminder

Front seats



The indicator lamps come on and an acoustic signal sounds. In addition, a message appears on the Control Display. Check whether the safety belt has been fastened correctly. The "Fasten safety belts" reminder is issued when the driver's safety belt has not been fastened. The "Fasten safety belts" reminder is also activated at road speeds above approx. 5 mph or 8 km/h if the front passenger's safety belt has not been fastened, if objects are placed on the front passenger seat, or if driver or front passenger unfasten their safety belts.



Damage to safety belts

 If the safety belts are damaged or stressed in an accident: have the safety belt system and its seat-belt tensioners replaced and the belt anchors checked. Have this work carried out only by a MINI dealer or by a workshop that has specially trained personnel working in accordance with the specifications of the MINI manufacturer; otherwise, correct operation of these safety systems is not ensured. ◀

MIRRORS

Exterior mirrors

 The front passenger's mirror is more convex than the driver's mirror. The objects seen in the mirror are closer than they appear. Do not gauge your distance from traffic behind you on the basis of what you see in the mirror; otherwise, there is an increased risk of an accident. ◀



- 1 Adjusting the left or right exterior mirror
- 2 Folding mirrors in and out*

Manual adjustment

The mirrors can also be adjusted manually: press the edge of the glass.

Folding mirrors in and out*

Turn the knob beyond the pressure point in direction 2. The mirrors can be folded in at road speeds up to approx. 20 mph/30 km/h.

This can be beneficial in narrow streets, for example, or for moving mirrors that were folded in by hand back out into their correct positions.

Automatic heating*

At outside temperatures below a certain limit, both exterior mirrors are automatically heated while the engine is running or the ignition switched on.

Interior rearview mirror

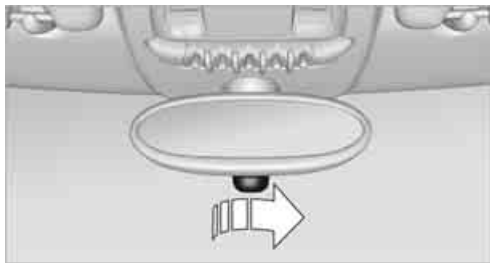

To reduce glare from vehicles behind you when you are driving at night:

Turn the knob.

Interior mirror, automatic dimming*

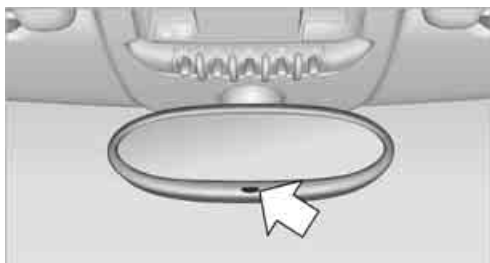

The automatic dimming feature of the interior rearview mirror* is controlled by two photo cells in the mirror. One photo cell is in the mirror frame, arrow; the other is on the back of the mirror.

In order to ensure that the system functions correctly, keep the photo cells clean, do not cover the area between the interior rearview mirror and windshield, and do not affix adhesive labels or stickers of any kind to the windshield directly in front of the mirror.

STEERING WHEEL

Adjustments

 Do not adjust the steering wheel position while the car is in motion; otherwise, there is a risk of accident due to an unexpected movement. ◀

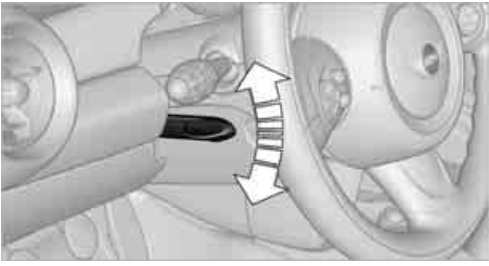

1. Fold the lever down.
2. Move the steering wheel to the preferred distance and angle to suit your seated position.
3. Swing the lever back up.



Do not use force to swing the lever back up; otherwise, the mechanism will be damaged. ◀

TRANSPORTING CHILDREN SAFELY

THE RIGHT PLACE FOR CHILDREN

 Do not leave children unattended in the vehicle; otherwise, they could endanger themselves and/or other persons by opening the doors, for example. ◀

Children should always sit in the rear

Accident research has shown that the safest place for children is on the rear seat.

 Only transport children under the age of 13 or smaller than 5 ft/150 cm in the rear in a child restraint system suitable for their age, weight and size. Otherwise, there is an increased risk of injury in the event of an accident. ◀

Children 13 years of age or older must be buckled in with a safety belt as soon as there no longer is any child restraint system that is appropriate for their age, size and weight.

 Only install child seats in the rear when the rear seat backrest is folded all the way back and engaged. Otherwise, there is an increased risk of injury in the event of an accident. ◀

Exception for front passenger seat

Front passenger airbags

 Should it be necessary to use a child restraint system on the front passenger seat, the front and side airbags must be deactivated. Otherwise, there is an increased risk of injury to the child if the airbags deploy, even if the child is seated in a child restraint system. ◀

For more information on automatic deactivation of the front passenger airbags, refer to page 79.

CHILD RESTRAINT SYSTEMS, INSTALLATION

 Observe the child restraint system manufacturer's instructions when selecting, installing and using child restraint systems. Otherwise, the protective effect may be diminished. ◀

On the front passenger seat

 After installing a child restraint system on the front passenger seat, make sure that the front and side airbags for the front passenger are deactivated; otherwise, there is an increased risk of injury if the airbags deploy. ◀

Seat position

Before installing a child restraint system, move the front passenger seat as far back and up* as possible to obtain the best possible position for the belt. Do not change the seat position after this.

Child seat security



All rear safety belts and the safety belt for the front passenger can be prevented from being pulled out in order to secure child restraint systems.

To lock the safety belt

1. Secure the child restraint system with the belt.
2. Pull the belt strap all the way out.
3. Allow the belt strap to retract and pull it taut against the child restraint system.

The safety belt is locked.

To unlock the safety belt

1. Open the belt buckle.
2. Remove the child restraint system.
3. Allow the safety belt strap to retract all the way.

LATCH CHILD-RESTRAINT FIXING SYSTEM

LATCH: lower Anchors and Tethers for Children.

 To install and use the LATCH child restraint system, follow the operating and safety instructions provided by the manufacturer of the system; otherwise, the protective function of the seat may be compromised. ◀

Anchor points for LATCH anchors

Before installing the child seat, pull the belt out of the area for the child-restraint fixing system.



The anchor points for the lower LATCH anchors are located behind the labeled protective caps.

 Make sure that both lower LATCH anchors are properly engaged and that the child restraint system rests firmly against the seat backrest; otherwise, the protective function of the seat may be compromised. ◀

Child restraint system with tether strap

 Use the tether strap anchors to secure child restraint systems only; otherwise, the anchors could be damaged. ◀

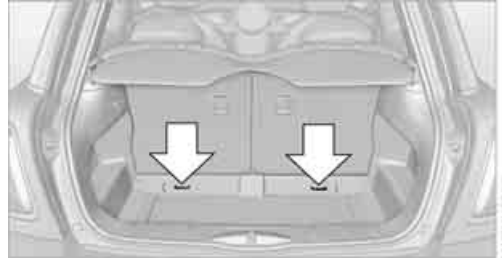

By way of example, the illustration shows the cargo bay in the MINI.

There are two additional anchors for child restraint systems with tether straps, arrows.

When the vehicle is equipped with a level load floor*, the anchors are covered. Their positions are labeled.

Placement of the tether strap

 Make sure the upper retaining strap does not run over sharp edges and is not twisted as it passes to the top anchor. Otherwise, the strap will not properly secure the child restraint system in the event of an accident. ◀

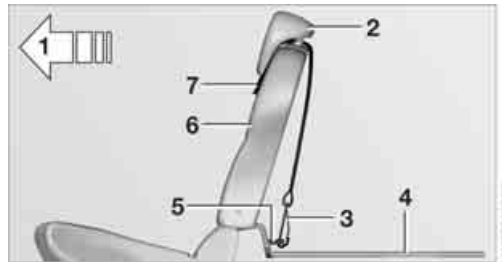

- 1 Direction of travel
- 2 Head restraint
- 3 Tether strap hook
- 4 Cargo bay floor
- 5 Anchor
- 6 Seat backrest
- 7 Tether strap of the child restraint system

1. Push the head restraint upward.
2. Guide the tether strap between the head restraint holders.
3. Attach the tether strap to the anchor using the hook.
4. Push the head restraint into its lowermost position.
5. Attach the tether strap to the anchor using the hook.
6. Pull the retaining strap tight.

DRIVING

IGNITION LOCK

Inserting the key into the ignition lock

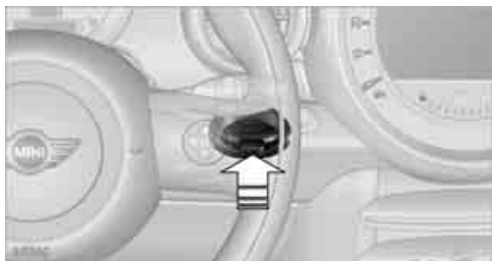

Insert the key all the way into the ignition lock.

Radio readiness

Individual electrical consumers can operate.

Removing the key from the ignition lock

Press in the key briefly. It is ejected slightly.

At the same time:

- ▷ The ignition is switched off if it was on beforehand.

Automatic transmission

You cannot take out the key unless the selector lever is in the P position: interlock.

START/STOP BUTTON



Press the start/stop button to switch radio readiness or the ignition on and off. Do not depress the brake or clutch while doing so.

- ▷ When you press the start/stop button and depress the clutch if the car has manual transmission or the brake if the car has automatic transmission, the engine starts. ◀

Radio readiness

Individual electrical consumers can operate. The time and outside temperature are displayed in the tachometer.

Radio readiness is switched off automatically:

- ▷ When the key is removed from the ignition lock
- ▷ When using Comfort Access* by pushing the button on the door handle or the  button on the remote control, refer to Locking on page 33
- ▷ after a certain has elapsed

Ignition on

Most indicator and warning lamps in indicator area 1, page 13, light up for varying lengths of time.

- ▷ When the engine is off, switch off the ignition and any unnecessary electrical consumers in order to preserve the battery. ◀

Radio readiness and ignition off

All indicator and warning lamps in the displays go out.

The ignition automatically turns off* when the driver's door is opened. Pressing the start/stop button again switches the ignition back on.

The ignition is not switched off in situations such as the following:

- ▷ The clutch or brake is depressed
- ▷ The low beams are switched on

STARTING THE ENGINE

 Do not allow the engine to run in enclosed areas; otherwise, inhalation of the noxious exhaust gases can lead to loss of consciousness and death. Exhaust gases contain carbon monoxide, an odorless and colorless, but highly toxic gas. Never leave an unattended vehicle with the engine running; otherwise, such a vehicle represents a potential safety hazard.

Before leaving the car while the engine is running, place the transmission in neutral or move the selector lever to position P and forcefully apply the parking brake to prevent the car from moving. ◀

 Avoid frequent starting in quick succession or repeated start attempts in which the engine does not start. Otherwise, the fuel is not burned or inadequately burned and there is a danger of overheating and damaging the catalytic converter. ◀

Do not let the engine warm up with the vehicle at a standstill. Move off immediately at a moderate engine speed.

When starting the engine, do not depress the accelerator pedal.



Manual transmission

Key in ignition lock or inside vehicle with Comfort Access, refer to page 33.

1. Depress the brake.
2. Depress the clutch.
3. Press the start/stop button.

Automatic transmission

Key in ignition lock or inside vehicle with Comfort Access, refer to page 33.

1. Depress the brake.
2. Shift the selector lever into position P or N.
3. Press the start/stop button.

The starter operates automatically for a certain time, and stops automatically as soon as the engine has started.

SWITCHING OFF THE ENGINE

 Always take the key with you when you leave the vehicle.

When parking, apply the parking brake forcefully; otherwise, the vehicle could begin to roll. ◀

Manual transmission

1. With the car at a standstill, press the start/stop button.
2. Shift into first gear or reverse.
3. Forcefully apply the parking brake.

Automatic transmission

1. With the car at a standstill, move the selector lever to position P.
2. Press the start/stop button.
3. Forcefully apply the parking brake.

Before driving into a car wash

By following these steps, the vehicle is able to roll:

1. Place the remote control, even with Comfort Access, in the ignition lock.
2. Depress the brake.
3. Move the selector lever to position N.
4. Switch off the engine.

PARKING BRAKE

The parking brake is primarily intended to prevent the vehicle from rolling while parked; it brakes the rear wheels.

Applying

The lever locks in position automatically.

Releasing

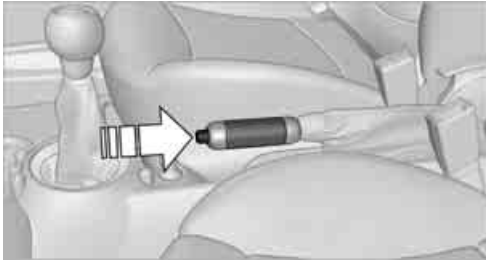

Pull slightly upwards, press the button and lower the lever.

⚠ In exceptional cases, if the parking brake has to be used to slow or stop the car, do not pull the lever up too hard. In doing so, continuously press the button of the parking brake lever.

Otherwise, excessive force could lead to over-braking and loss of traction, i.e. fishtailing, at the rear axle. ◀

MANUAL TRANSMISSION



⚠ When shifting into 5th or 6th gear, press the gearshift lever to the right. Otherwise, the engine could be damaged if you inadvertently shift into 3rd or 4th gear. ◀

Reverse gear

Select this only when the vehicle is stationary. When the gearshift lever is pressed to the left, a slight resistance has to be overcome.

AUTOMATIC TRANSMISSION* WITH STEPTRONIC

In addition to the fully automatic mode, you can shift gears manually using Steptronic, page 49.

Parking the vehicle

⚠ To prevent the vehicle from rolling, always select position P and apply the parking brake before leaving the vehicle with the engine running. ◀

Removing the key

1. Move the selector lever to position P.
2. Switch off the engine.
3. Remove the key.

Selector lever positions

P R N D M/S + -

Displays in the tachometer



P R N D DS M1 to M6

The selector lever position is displayed, or the current gear in the manual mode.

Changing selector lever positions

- ▷ The selector lever can only be moved out of position P if the ignition is switched on or the engine is running: interlock.
- ▷ Before moving the lever away from P or N with the vehicle stationary, first depress the brake; otherwise, the selector lever will refuse to move: shiftlock.

 To prevent the vehicle from creeping after you select a driving position, depress the brake until you are ready to start. ◀

A lock prevents accidental shifting into selector lever positions R and P.

Overriding the selector lever lock



Press the button on the front of the selector lever, arrow.

P Park

Select this only when the vehicle is stationary. The transmission locks to prevent the drive wheels from turning.

R Reverse

Select this only when the vehicle is stationary.

N Neutral

Select this when you are in a car wash, for example. The vehicle can roll.

D Drive, automatic position

Position for normal vehicle operation. All forward gears are selected automatically.

Under normal operation conditions, fuel consumption is lowest when you drive in position D.

Kickdown

Kickdown enables you to achieve maximum performance.

Depress the accelerator pedal beyond the full-throttle resistance point.

Sport program and manual operation M/S



Move the selector lever from position D to the left into the M/S shifting slot: The Sport program is activated and DS is displayed. This position is recommended for a performance-oriented driving style.

To deactivate the sport program or manual mode M/S, move the selector lever to the right into position D.

Shifting with the selector lever

Push the selector lever forward or pull it back to activate manual operation. Steptronic shifts the gear.

- ▷ Pull the selector lever in the + direction. Transmission shifts up.
- ▷ Push the selector lever in the – direction. Transmission shifts down.

The selected gear is displayed in the tachometer, e.g. M1.

To use the automatic mode again, move the selector lever to the right into position D.

Upshifts and downshifts are executed only when they will result in a plausible combination of engine and vehicle speed; thus, for example, a downshift that would cause the engine to over-rev will not be executed by the system. The selected gear is displayed briefly, followed by the current gear.

Shifting on the steering wheel*

With the selector lever in position D, automatic drive, you can shift gears using the shift paddles on the steering wheel. The transmission automatically switches to manual mode.

If you do not shift gears with the shift paddles or accelerate for a certain amount of time, the transmission automatically returns to D, automatic drive.



- ▷ Pull one of the shift paddles. Transmission shifts up.
- ▷ Push one of the shift paddles. Transmission shifts down.

M1 to M6 is displayed in the gear indicator.

Manually unlock the selector lever lock

Should the selector lever refuse to move out of position P even though the ignition is switched on, the brake is depressed and the button on the selector lever is pressed, the selector lever lock can be overridden:

1. Unclip the sleeve of the selector lever.
2. Pull the sleeve up over the selector lever until the sleeve is inside out. Disconnect the cable connector if necessary.

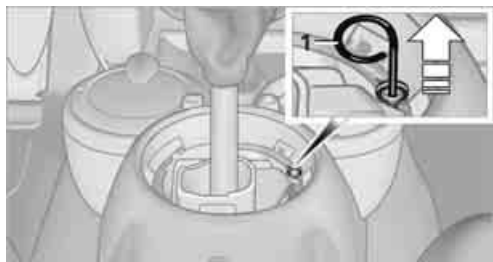

3. Insert extractor hook 1 from the onboard vehicle tool kit into the loop on the passenger's side.
4. Pull the loop up.
5. Move the selector lever into the desired position by pressing the button on the front of the selector lever.

▷ Only unlock the selector lever lock manually when the vehicle is to be towed. Do not forget to firmly apply the parking brake prior to the tow; otherwise, the vehicle may roll away. ◀

TURN SIGNALS/ HEADLAMP FLASHER

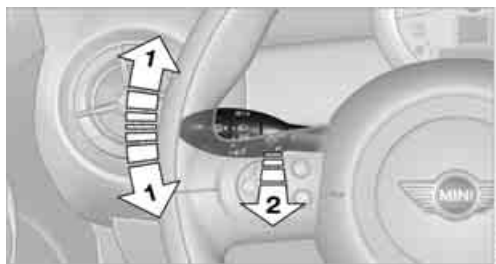

- 1 Turn signal indicator
- 2 Headlamp flasher

Using turn signals

Press the lever beyond the resistance point.

To turn off manually, press the lever to the resistance point.

▷ Unusually rapid flashing of the indicator lamp indicates that an indicator bulb has failed. ◀

Indicating a turn briefly

Press the lever as far as the resistance point for as long as you wish to indicate a turn.

Triple turn signal activation

Press the lever as far as the resistance point.

You can set whether the turn signal is to flash once or three times.

1. Press the  button. This opens the start menu.
2. Move the MINI joystick to highlight "Setup" and press the MINI joystick.
3. Select "Settings".
4. Select "Vehicle and tires".

- Select "Lighting".



- Select "Triple turn signal".

Triple turn signaling is activated.

WIPER SYSTEM

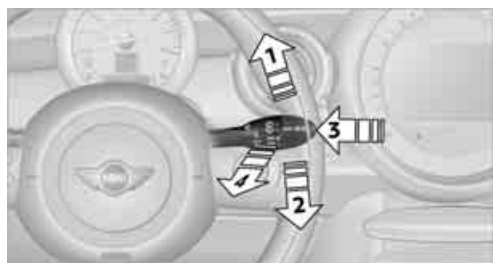

- Switching on wipers
- Switching off wipers or brief wipe
- Activating/deactivating intermittent mode or rain sensor*
- Cleaning windshield and headlamps*

Switching on wipers

Press the lever upward, arrow 1.

The lever automatically returns to its initial position when released.

Normal wiper speed

Press once.

The system switches to intermittent operation when the vehicle is stationary.

Fast wiper speed

Press twice or press beyond the resistance point. The system switches to normal speed when the vehicle is stationary.

Intermittent wipe or rain sensor*

If the car is not equipped with a rain sensor, the intermittent-wipe time is preset.

If the car is equipped with a rain sensor, the time between wipes is controlled automatically and depends on the intensity of the rainfall. The rain sensor is mounted on the windshield, directly in front of the interior rearview mirror.

Activating intermittent wipe or rain sensor

Press button, arrow 3.

 Deactivate the rain sensor before entering an automatic car wash. Failure to do so could result in damage caused by undesired wiper activation. ◀

Adjusting the sensitivity of the rain sensor

- Switch on the ignition, refer to page 46.
- Briefly press the button in the turn indicator lever repeatedly until "SET/INFO" is displayed.



- Press and hold the button until the display changes.
- Briefly press the button repeatedly until the symbol and "SET" are displayed.



- Press and hold the button until the display changes.



- Press the button to select the desired sensitivity.
- Wait, or press and hold the button until the display changes. The settings are stored.

Deactivating intermittent wipe or rain sensor

Press the button again, arrow 3.

Brief wipe

Press the lever downward once, arrow 2.

Cleaning windshield and headlamps*

Pull the lever, arrow 4.

Washer fluid is sprayed onto the windshield and the wipers are operated briefly.

When the vehicle lighting system is switched on, the headlamps are cleaned at regular and appropriate intervals.

In cars equipped with an alarm system, the headlamps cannot be cleaned when the hood is open.

⚠ Do not use the washers when the washer fluid reservoir is empty; otherwise, you will damage the washer pump.

Only use the washers if the hood has been completely closed; otherwise, the headlamp washer system* may be damaged. Do not use the washers if there is any danger that the fluid will freeze on the windshield. If you do, your vision could be obscured. For this reason, use anti-freeze. ◀

Window washer nozzles



The window washer nozzles are heated automatically* while the engine is running or the ignition is switched on.

Rear window wiper



- Rear wipers parked
- To switch on intermittent wipe  : Turn the cap to level 1. Operation is continuous in reverse gear.

Cleaning the rear window

- To clean the rear window during intermittent wipe  : Turn the cap further to level 2 and hold it there.
- To clean the rear window when wipers are parked  : Turn the cap to level 3 and hold it there.

⚠ Do not use the washers when the washer fluid reservoir is empty; otherwise, you will damage the washer pump. ◀

WASHER FLUID

⚠ Washer fluid antifreeze is flammable. Therefore, keep it away from ignition sources, store it only in the closed original container and keep it out of reach of children; otherwise, there is a risk of personal injury. Comply with the instructions on the container. ◀

Washer fluid reservoir

⚠ Only refill washer fluid that contains anti-freeze when the engine is cool, to avoid contact with hot engine parts. Otherwise, fluid spills constitute a fire hazard and a risk to personal safety. ◀



Fill with water and, if required, with a washer antifreeze, according to manufacturer's recommendations.

 Mix the water and antifreeze before filling the washer fluid reservoir to make sure the correct concentration is maintained. ◀

Capacity

Approx. 2.6 US quarts/2.5 liters.

With headlamp washer system:

Approx. 4.8 US quarts/4.5 liters.

CRUISE CONTROL*

The concept

Cruise control is available at vehicle speeds of at least approx. 20 mph or 30 km/h. The car then stores and maintains the speed that you specify using the button on the steering wheel.

 Do not use cruise control when driving at constant speed is prevented by adverse conditions, e.g. winding roads, dense traffic or poor road conditions due to, e.g., snow, rain, ice or loose surfaces. Otherwise, you could lose control of the vehicle and cause an accident as a result. ◀

Activating



- 1 Resuming cruise control
- 2 Activating/deactivating cruise control
- 3 Maintaining, storing and increasing speed
- 4 Maintaining, storing and decreasing speed

Indicator lamp in the speedometer lights up. The cruise control system is ready and can be activated.

Activating/deactivating cruise control

Press button **2**.

In addition, the system is automatically deactivated:

- ▷ When the brakes are applied
- ▷ When the clutch is depressed
- ▷ When the automatic transmission is in selection lever position N
- ▷ When the driving stability control system is active

Cruise control is not deactivated by depressing the accelerator pedal. Once the accelerator pedal is released, the stored speed is achieved again and maintained.

The stored speed is cleared when the ignition is switched off.

Maintaining current speed

Press button **3**.

The system maintains and stores the current vehicle speed.

If, on a downhill grade, the engine braking effect is not sufficient, the controlled speed may be exceeded. On uphill grades vehicle speed may drop if the engine output is insufficient.

Increasing speed

Press button **3** repeatedly until the desired speed is reached. Every time you press the button, the speed increases by approx. 1 mph or 2 km/h.

Accelerating using the button

Press and hold button **3**.

The vehicle accelerates without pressure on the accelerator pedal. After the button is released, the driving speed is maintained and stored.

Decreasing speed

Press button **4** repeatedly until the desired speed is reached.

The functions here are the same as for increasing the speed or accelerating, except that the speed will be decreased.

Resuming a speed stored beforehand

Press button **1**.

The last speed stored is achieved again and maintained.

The stored speed is cleared when the ignition is switched off.

Display in tachometer*



Selected speed is displayed briefly.

 If --- mph or --- km/h is displayed briefly in the tachometer, the conditions necessary for operation may not be fulfilled. ◀

Malfunction

 The warning lamp in the tachometer lights up if the system fails. A message appears on the Control Display.

CONTROLS OVERVIEW

ODOMETER, OUTSIDE TEMPERATURE DISPLAY, CLOCK

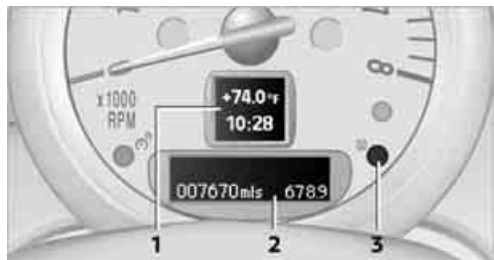

- 1 Outside temperature display and clock or current speed
- 2 Odometer and trip odometer
- 3 Resetting the trip odometer

Units of measure

Select the respective units of measure, miles or km for the odometer as well as °F or °C for the outside temperature, page 60.

Outside temperature display, time

Setting the time, refer to page 63.

Outside temperature warning

When the displayed temperature sinks to approx. +37 °F / +3 °C, a signal sounds and a warning lamp lights up. There is an increased risk of black ice.

 Black ice can also form at temperatures above +37 °F / +3 °C. Therefore, drive carefully, e.g. on bridges and sections of road in the shade; otherwise, there is an increased accident risk. ◀

Current vehicle speed

To have the current speed shown in the upper display otherwise serving for the outside temperature display and clock.

1. Press the button in the turn indicator lever repeatedly until the current speed appears in the lower display.
2. Wait for the speed display to automatically move to the upper display.

The outside temperature then appears in the lower display.

Odometer and trip odometer

Resetting the trip odometer

With the ignition switched on, press knob **3** in the tachometer.

When the vehicle is parked

To display the time, outside temperature and odometer briefly after the key is removed from the ignition lock:

Press knob **3** in the tachometer.

TACHOMETER



Never operate the engine with the needle in the red overspeed zone of the gauge. In this range, the fuel supply is interrupted to protect the engine.

COOLANT TEMPERATURE

A warning lamp will come on if the coolant, and therefore the engine, becomes too hot. In addition, a message will appear on the Control Display.

Check coolant level, refer to page 169.

FUEL GAUGE

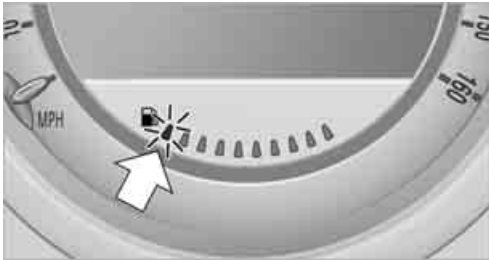

Fuel tank capacity

Approx. 13.2 US gallons/50 liters.

You can find information on refueling on page 156.

If the tilt of the vehicle varies for a longer period, when you are driving in mountainous areas, for example, the indicator may fluctuate slightly.

Reserve

Once the fuel level has fallen to the reserve zone of approx. 2.1 US gallons/8 liters the remaining indicator lamps change from orange to red, arrow, and a message is displayed briefly on the Control Display. The tachometer displays the remaining cruising range. When the range is less than approx. 30 miles/50 km, the message remains in the Control Display.

 If the range displayed is less than 30 miles/50 km, be sure to refuel; otherwise, engine functions are not guaranteed and damage could occur. ◀

COMPUTER*

Displays in tachometer



Press the button in the turn indicator lever repeatedly to call up various items of information.

The following items of information are displayed in the order listed:

- ▷ Cruising range
- ▷ Average fuel consumption
- ▷ Current fuel consumption
- ▷ Average speed
- ▷ Current vehicle speed

To set the corresponding units of measure, refer to Units of measure on page 60.

Cruising range

Displays the estimated cruising range available with the remaining fuel. The range is calculated on the basis of the way the car has been driven over the last 18 miles/30 km and the amount of fuel currently in the tank.

 If the range displayed is less than 30 miles/50 km, be sure to refuel; otherwise, engine functions are not guaranteed and damage could occur. ◀

Average fuel consumption

Calculated for the time the engine has been running.

With the trip computer, page 58, you can have the average fuel consumption for another trip displayed.

To reset average fuel consumption: press the button in the turn indicator lever for approx. 2 seconds.

Current fuel consumption

Displays the current fuel consumption to allow you to see whether your current driving style is conducive to fuel economy with minimum exhaust emissions.

Average speed

Periods with the vehicle parked and the engine switched off are not included in the calculations of average speed.

With the trip computer, page 58, you can have the average speed for another trip displayed.

To reset average speed: press the button in the turn indicator lever for approx. 2 seconds.

Current vehicle speed

To have the current speed shown in the upper display otherwise serving for the outside temperature display and clock.

1. Press the button in the turn indicator lever repeatedly until the current speed appears in the lower display.
2. Wait for the speed display to automatically move to the upper display.

The outside temperature then appears in the lower display of the computer.

Displays on the Control Display

To access the computer via the onboard monitor, basic operation on page 16.

1. Press the  button. This opens the start menu.
2. Move the MINI joystick to highlight "Navigation" and press the MINI joystick.

3. If necessary, move the highlight marker to the uppermost field. Select "Car Data".



4. Select "Onboard info".

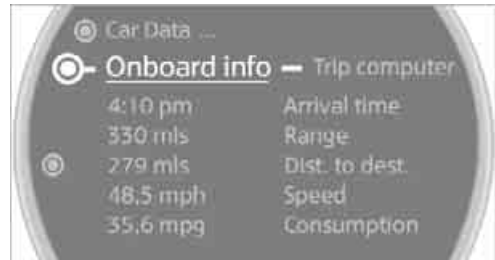

- ▷ Estimated time of arrival at destination:
 - ▷ Manually enter a distance in the computer, refer to information further below
 - ▷ Enter a destination in the navigation system, page 108
- ▷ Cruising range
- ▷ Distance to destination:
 - ▷ Manually enter a distance in the computer, refer to information further below
 - ▷ Enter a destination in the navigation system, page 108
- ▷ Average speed
- ▷ Average fuel consumption

Resetting values

To reset the values for the average speed and average fuel consumption:

1. Select the respective menu entry.
2. Press the MINI joystick to confirm the message.

Entering a distance manually

1. Select "Dist. to dest."

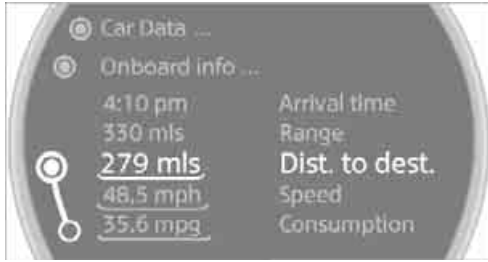

2. Turn the MINI joystick to select the distance to your destination.
3. Press the MINI joystick to apply the setting.

The distance is mandated automatically during destination guidance.

Trip computer

The trip computer is suitable e.g. for a holiday trip.

1. Press the  button.
This opens the start menu.
2. Move the MINI joystick to highlight "Navigation" and press the MINI joystick.
3. Select "Car Data".
4. Select "Trip computer".



- ▷ Departure time
- ▷ Driving time
- ▷ Distance traveled
- ▷ Average speed
- ▷ Average fuel consumption

To switch trip computer on/off and to reset all values to zero:

1. If necessary, move the highlight marker to the third field from the top.
2. Press the MINI joystick.
Other menu items are displayed.
3. Select the desired menu item.
 - ▷ "Start"
 - ▷ "Stop"
 - ▷ "Reset"

SETTINGS AND INFORMATION

Operating principle

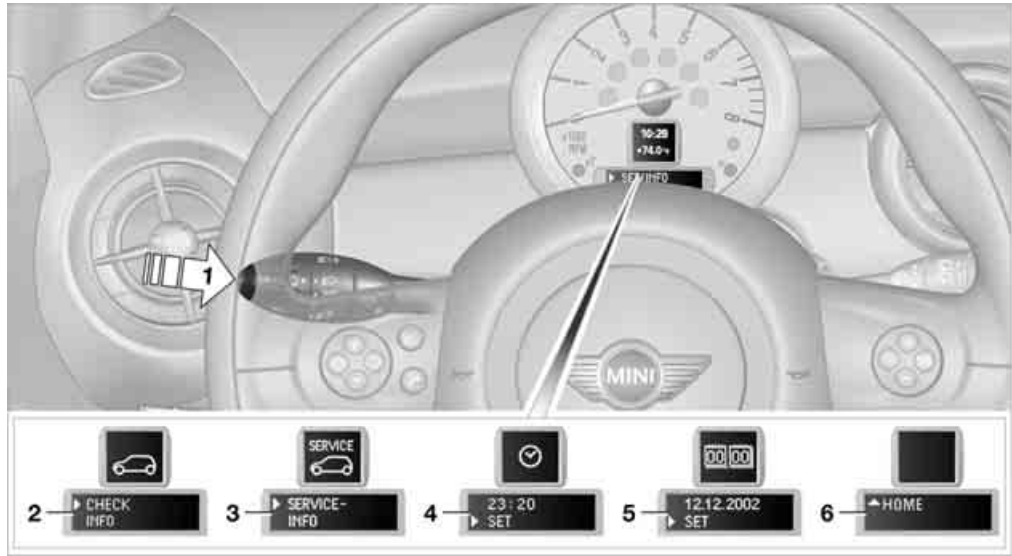

Certain settings and information are only available when the ignition is switched on, the vehicle is at a standstill and the doors are closed.

1 Button for:

- ▷ Selecting display
- ▷ Setting values
- ▷ Confirming selected display or set values
- ▷ Calling up computer information 56

- 2 Calling up Check Control 65
- 3 Displaying vehicle check 66
- 4 Setting the time 63
- 5 Setting the date 64
- 6 Exiting the menu

Exiting displays



1. Briefly press the button in the turn indicator lever repeatedly until "HOME" is displayed.
2. Press the button for a longer period.

The display again shows the outside temperature and the time.

Displays are also exited if no entries are made for approx. 8 seconds.

Next setting or item of information



1. While in a setting or information item, briefly press the button in the turn indicator lever repeatedly until "NEXT" is displayed.
2. Press the button for a longer period.

The display changes directly to the next setting or item of information.

UNITS OF MEASURE

To set the units of measure. The settings are stored for the remote control currently in use, refer also to Personal Profile on page 26.

1. Press the  button.
This opens the start menu.
2. Move the MINI joystick to highlight "Setup" and press the MINI joystick.
3. Select "Settings".
4. Select "Language / Units".
5. Select "Units".

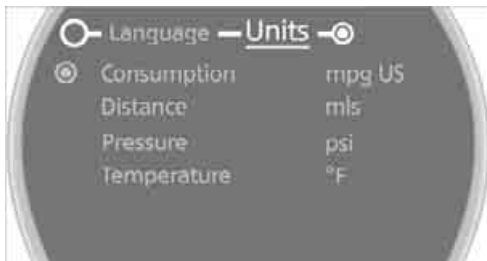

6. Select the menu item to be set.
7. Select the desired unit of measure.

SERVICE REQUIREMENTS



The remaining driving distance and the date of the next scheduled service are briefly displayed immediately after you start the engine or switch on the ignition.



The extent of service work required can be read out from the remote control by your MINI dealer. ◀

Possible displays

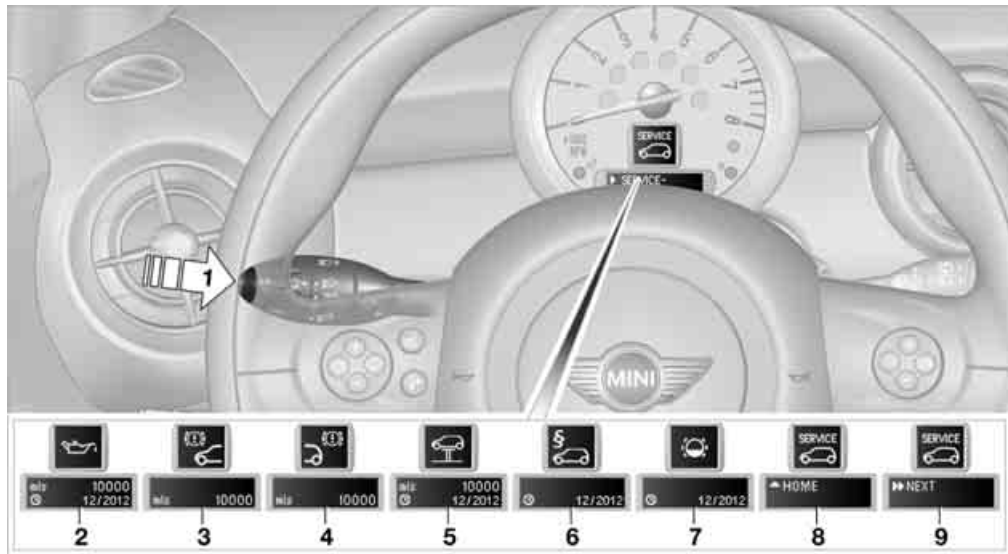

- 1 Button for selecting information
- 2 Engine oil
- 3 Front brakes
- 4 Rear brakes
- 5 Vehicle check

- 6 Roadworthiness test
- 7 Brake fluid
- 8 Exit display [59](#)
- 9 Next setting or item of information [60](#)

More information on the MINI Maintenance System can be found on page [170](#).

Supplementary information

You can have further information on the scope of maintenance displayed on the Control Display, refer to page [16](#).

1. Press the button. This opens the start menu.
2. Move the MINI joystick to highlight "Setup" and press the MINI joystick.
3. Select "Info sources".



4. Select "Service Info".
5. Select "Service requirements".

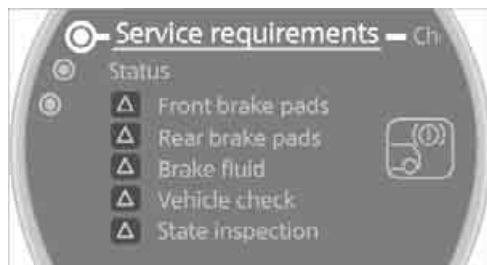

6. If necessary, move the highlight marker to the second field from the top. Select "Status".

A list of selected maintenance operations and, if applicable, inspections required by law is displayed.



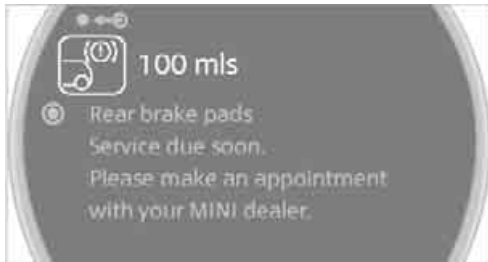

You can have further information displayed on each entry:
Select an entry.



Exiting the menu

↩ Select the arrow.

Symbols

-  No service is currently required.
-  The deadline for service or a legally mandated inspection is approaching. Please schedule a service appointment.
-  The service deadline has already passed.

Entering deadlines for legally required inspections*

Make sure the date on the Control Display is always set correctly, page 64; otherwise, the effectiveness of Condition Based Service CBS is not ensured.

1. Press the  button. This opens the start menu.
2. Move the MINI joystick to highlight "Setup" and press the MINI joystick.
3. Select "Info sources".
4. Select "Service Info".
5. If necessary, move the highlight marker to the uppermost field. Select "Service requirements".
6. Select "Status".
7. Select "State inspection".



8. Select "Set service date". The month is highlighted.
9. Turn the MINI joystick to make the adjustment.



10. Press the MINI joystick to apply the setting. The year is highlighted.
11. Turn the MINI joystick to make the adjustment.
12. Press the MINI joystick to apply the setting. The date entry is stored.

Exiting the menu

↩ Select the arrow.

CLOCK

In the tachometer

Setting the time

1. Briefly press the button in the turn indicator lever repeatedly until "SET/INFO" is displayed.



2. Press and hold the button until the display changes.
3. Briefly press the button repeatedly until the symbol and "SET" are displayed.



4. Press and hold the button until the display changes.
5. Press the button to set the hours.
6. Wait for the display to change to minutes.
7. Press the button to set the minutes.
8. Wait for the display to change. The settings are stored.

On the onboard monitor

Setting the time

1. Press the  button once or twice until the start menu appears.



2. Move the MINI joystick to highlight "Setup" and press the MINI joystick.
3. Turn the MINI joystick until "Settings" is selected and press the MINI joystick.



4. Turn the MINI joystick until "Time / Date" is selected and press the MINI joystick.



- Turn the MINI joystick until "Time" is selected and press the MINI joystick.

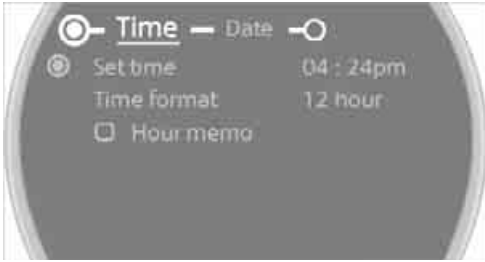

- Turn the MINI joystick until "Set time" is selected and press the MINI joystick.

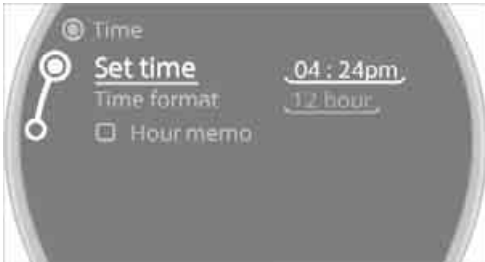

- Turn the MINI joystick to set the hours and press the MINI joystick.
- Turn the MINI joystick to set the minutes and press the MINI joystick.

The system accepts the new time.

Setting the time format

The settings are stored for the remote control currently in use, refer also to Personal Profile on page 26.

- Press the  button. This opens the start menu.
- Move the MINI joystick to highlight "Setup" and press the MINI joystick.
- Select "Settings".
- Select "Time / Date".
- Select "Time".
- Select "Time format".
- Select the desired format.

Switching on the hour signal*

You will hear three tones just before each full hour.

Select "Hour memo".

- The hour signal is activated.

The settings are stored for the remote control currently in use, refer also to Personal Profile on page 26.

DATE

In the tachometer

Setting the date

- Briefly press the button in the turn indicator lever repeatedly until "SET/INFO" is displayed.



- Press and hold the button until the display changes.
- Briefly press the button repeatedly until the symbol and "SET" are displayed.



- Press and hold the button until the display changes.
- Press the button to set the day of the month.
- Wait for the display to change to month.

- Set the month and year in the same way.
- Wait for the display to change.
The settings are stored.

On the onboard monitor

Setting the date

- Press the  button.
This opens the start menu.
- Move the MINI joystick to highlight "Setup" and press the MINI joystick.
- Select "Settings".
- Select "Time / Date".
- Select "Date".

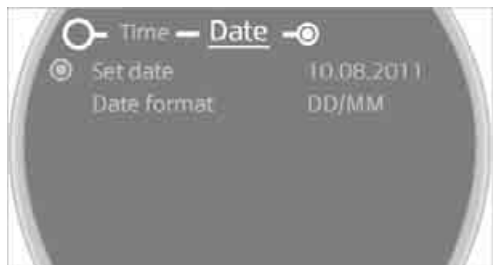

- Select "Set date".
- Turn the MINI joystick to make the adjustment.
- Press the MINI joystick to apply the setting.
The next setting is highlighted.
- Make the remaining adjustments. After the last adjustment, the date is stored.

Setting the date format

The settings are stored for the remote control currently in use, refer also to Personal Profile on page 26.

- Press the  button.
This opens the start menu.
- Move the MINI joystick to highlight "Setup" and press the MINI joystick.
- Select "Settings".
- Select "Time / Date".
- Select "Date".

- Select "Date format".
- Select the desired format.

CHECK CONTROL

The concept

The Check Control monitors vehicle functions and alerts you to any malfunctions in the systems monitored. Check Control messages involve indicator and warning lamps in the display and, in some circumstances, an acoustic signal as well as text messages at the bottom of the Control Display.

Indicator and warning lamps

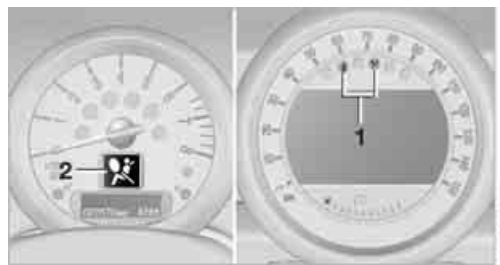

Indicator and warning lamps can light up in various combinations and colors in the indicator areas 1 and 2.

Explanatory text messages



Text messages at the lower edge of the Control Display explain the meaning of the displayed indicator and warning lamps.



For most Check Control messages, you can view more information later, e.g. regarding the cause of a malfunction and how to respond, refer to page 67.

In urgent cases, this information will be shown as soon as the corresponding lamp comes on.

To exit the displayed information:

↩ Select the arrow.

Hiding Check Control messages

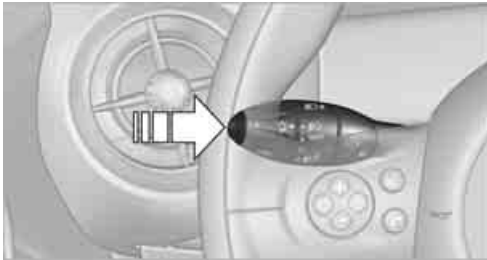

Press the button in the turn indicator lever.



Some Check Control messages are displayed until the malfunctions have been rectified. They cannot be hidden. If several malfunctions occur at the same time, they are displayed in succession.

⚠ They are marked with the symbol shown here.

Other Check Control messages are automatically hidden after approx. 20 seconds, but remain stored.

⚠ They are marked with the symbol shown here.

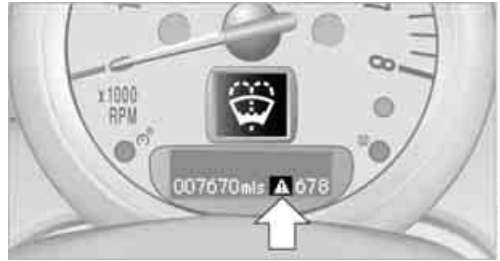

⚠ This symbol indicates that Check Control messages have been stored. Check Control messages can be viewed whenever it is convenient.

Viewing stored Check Control messages

Stored Check Control messages can only be displayed if the driver's door is closed.

1. Briefly press the button in the turn indicator lever repeatedly until "SET/INFO" is displayed.



2. Press and hold the button until the display changes.

- Briefly press the button repeatedly until the corresponding symbol and "CHECK INFO" are displayed.



- If necessary, move the highlight marker to the uppermost field. Select "Check Control messages".

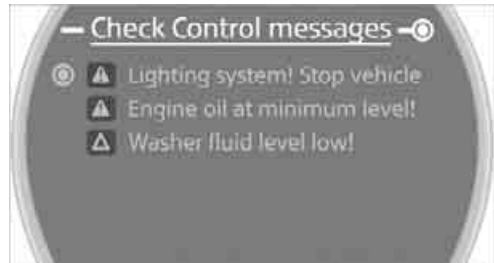

- Hold the button down. If there are no Check Control messages, then "CHECK OK" is displayed. If a Check Control message has been stored, the corresponding message is displayed. In addition, the text message appears on the Control Display.
- Briefly press the button to check for other messages.

- Select a text message.

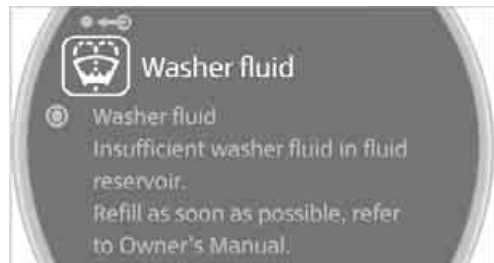

Viewing more information later

Onboard monitor, for operating principle refer to page 16.

- Press the button. This opens the start menu.
- Move the MINI joystick to highlight "Setup" and press the MINI joystick.
- Select "Info sources".



- Select "Service Info".

Exit display:

Select the arrow.

SPEED LIMIT

Enter a speed, and a Check Control message will indicate when you reach this speed. This enables you, for example, to receive warnings if you exceed a speed limit in an urban area.

You are only warned of reaching this speed a second time if your vehicle speed falls below it again by at least 3 mph or 5 km/h.

Displaying, setting or changing the limit

Onboard monitor, for operating principle refer to page 16.

- Press the button. This opens the start menu.
- Move the MINI joystick to highlight "Navigation" and press the MINI joystick.
- Select "Car Data".

4. Select "Limit".



5. Select "Change limit:".
6. Turn the MINI joystick to set the limit.
7. Press the MINI joystick to apply the setting.
The limit is automatically activated.

Applying your current speed as limit

Select "Select current speed".

The system adopts your current speed as the limit.

Activating the limit

Select "On".

Limit is activated.

STOPWATCH

Onboard monitor, for operating principle refer to page 16.

1. Press the button.
This opens the start menu.
2. Move the MINI joystick to highlight "Navigation" and press the MINI joystick.
3. Select "Car Data".
4. Select "Stopwatch".

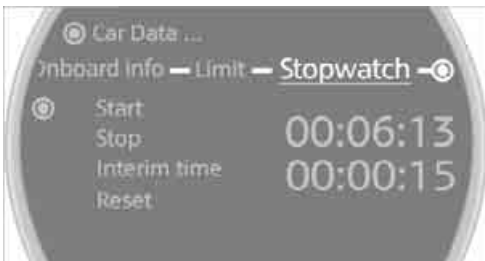

Starting, stopping or resetting

- ▷ Select "Start".
The stopwatch starts at the displayed time.
- ▷ Select "Reset".
The stopwatch is reset and restarts if it was running beforehand.
- ▷ Select "Stop".
This stops the timer.

Taking an interim time reading

Select "Interim time".

The interim time appears below the ongoing primary stopwatch count.

All of the remaining functions remain available at all times while the stopwatch is running. The stopwatch continues operation in the background.

ALTERING SETTINGS

Language on the Control Display

The language of the Control Display can be set. Refer to the basic principles on page 16. The setting is stored for the remote control currently in use.

1. Press the button.
This opens the start menu.
2. Move the MINI joystick to highlight "Setup" and press the MINI joystick.
3. Select "Settings".



4. Select "Language / Units".

5. Select "Language".



6. Select "Text language".
The language for the display texts and navigation messages can be changed.
7. Select the desired language.

Brightness of the Control Display

The brightness is automatically adapted to the ambient lighting conditions. Note, however, that you can change the basic setting while the low beams are switched on. The setting is stored for the remote control currently in use.

1. Press the  button.
This opens the start menu.
2. Move the MINI joystick to highlight "Setup" and press the MINI joystick.
3. Select "Settings".
4. Select "Display settings".
5. Select "Brightness".



6. Select "Brightness".
7. Turn the MINI joystick until the desired setting is reached.

TECHNOLOGY FOR DRIVING COMFORT AND SAFETY

PARK DISTANCE CONTROL PDC*

The concept

PDC assists you with parking backwards. Acoustic signals and a visual indicator warn you of the presence of an object behind the vehicle. To measure the distance, there are four ultrasonic sensors in either bumper.

 These sensors have a range of approx. 6.5 ft/2 m. However, an acoustic warning does not sound until an object is approx. 24 in/60 cm from the rear corner sensors, or approx. 5 ft/1.50 m from the rear center sensors. PDC is a parking aid that can indicate objects when they are approached slowly, as is usually the case when parking. Avoid approaching an object at high speed; otherwise, physical circumstances may lead to the system warning being issued too late. ◀

Automatic mode

With the engine running or the ignition switched on, the system is activated automatically after approx. 1 second when you engage reverse gear or move the automatic transmission selector lever to position R. Wait this short period before driving.

Acoustic signals

As the distance between vehicle and object decreases, the intervals between the tones become shorter. If the distance to the nearest object falls to below roughly 1 ft/30 cm, then a continuous tone sounds.

If the distance remains constant, e.g. when driving parallel to a wall, the acoustic signal stops after approx. 3 seconds.

Malfunction



Indicator lamp comes on: PDC has failed. A message appears on the Control Display. Have the system checked.

To avoid this problem, keep the sensors clean and free of ice or snow in order to ensure that they will continue to operate effectively. When using a high-pressure cleaner, do not direct the jet toward the sensors for lengthy periods and only spray from a distance of at least 4 in/10 cm.

PDC with visual warning

To have the system show distances to objects on the Control Display. The contours of distant objects are shown on the Control Display even before the acoustic signal sounds.

Onboard monitor, for operating principle refer to page 16.

1. Press the  button. This opens the start menu.
2. Move the MINI joystick to highlight "Setup" and press the MINI joystick.
3. Select "Settings".

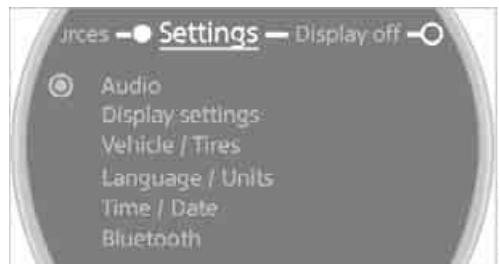

4. Select "Vehicle and tires".

- If necessary, move the highlight marker to the uppermost field. Select "PDC".

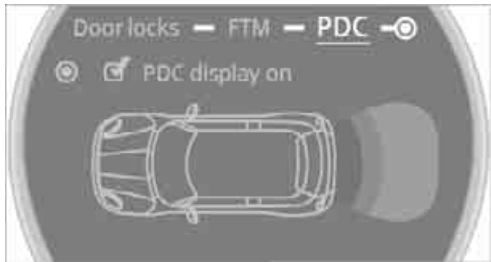

- Select "PDC display on".

The PDC display is activated. It is shown on the Control Display as soon as PDC is activated. The setting is stored for the remote control in use.

System limitations

 Even with PDC, final responsibility for estimating the distance between the vehicle and any obstructions always remains with the driver. Sensors, too, have blind spots in which objects cannot be detected. Moreover, ultrasonic detection can reach its physical limits with objects such as trailer tow bars and couplings, thin and wedge-shaped objects, etc. Low objects already indicated, such as curbs, may enter the sensors' blind spots before or after a continuous audible signal is given. Higher, protruding objects, such as wall ledges, may not be detectable. Therefore, always drive cautiously; otherwise, there is a risk of personal injury or property damage. Loud sound sources outside or inside the car can drown out the PDC signal. ◀

DRIVING STABILITY CONTROL SYSTEMS

Your MINI has a number of systems that help to maintain the vehicle's stability even in adverse driving conditions.

 The laws of physics cannot be repealed, even with driving stability control systems. An appropriate driving style always remains the responsibility of the driver. Therefore do not

reduce the additional safety margin by engaging in hazardous driving thereby running the risk of an accident. ◀

Antilock Brake System ABS

ABS prevents locking of the wheels during braking. Safe steering response is maintained even during full braking. Active safety is thus increased.

Braking safely, refer to page 97.

Among others, ABS includes the following functions:

- ▷ Cornering Brake Control CBC
- ▷ Electronic brake-force distribution EBV
- ▷ Brake Assist

Cornering Brake Control CBC

Driving stability and steering characteristics are further enhanced while braking in turns or during a lane change.

Electronic brake-force distribution EBV

The system controls the brake pressure in the rear wheels to ensure stable braking behavior.

Brake Assist

Rapidly depressing the brake causes this system to automatically develop maximum braking force. Thus, the system helps keep braking distance to a minimum. At the same time, all the benefits provided by ABS are exploited.

Do not reduce the pressure on the brake for the duration of the full braking application.

Dynamic Stability Control DSC

DSC prevents the driving wheels from losing traction when you pull away from rest or accelerate. The system also recognizes unstable driving conditions, for example if the rear of the car is about to swerve or if momentum is acting at an angle past the front wheels. In these cases, DSC helps the vehicle maintain a safe course within physical limits by reducing engine output and through braking actions at the individual wheels.

DSC also encompasses the following functions:

- ▷ Antilock Brake System ABS
- ▷ Electronic brake-force distribution EBV
- ▷ Brake Assist
- ▷ Cornering Brake Control CBC
- ▷ Hill Assist

Deactivating DSC



Press the button repeatedly until the DSC indicator lamps come on. DSC is deactivated. Stabilizing and propulsion promoting actions are no longer executed.

When driving with snow chains or to 'rock free' in snow, it can be helpful to switch off DSC for a brief period.

To increase vehicle stability, activate DSC again as soon as possible.

Activating DSC

Press the button again: the DSC indicator lamps go out.

For better control

 If the indicator lamp flashes:
The DSC controls the driving and braking forces.

 If the indicator lamps are on:
DSC is deactivated.



Dynamic Traction Control DTC*

DTC is a type of DSC that is propulsion optimized for special road conditions such as uncleared snowy roads. The system ensures maximum propulsion though with restricted driving stability. You therefore need to drive with suitable caution.

In the following exceptional situations, it can be useful to briefly activate DTC:

- ▷ when driving on snow-covered inclines, in slush, or on uncleared snowy roads
- ▷ when rocking the vehicle free, driving out of deep snow or on loose surfaces
- ▷ when driving with snow chains

Activating DTC



Press the button: the DTC indicator lamps come on.

For better control



If the indicator lamp flashes:
DTC controls the driving and braking forces.

DTC



If the indicator lamps are on:
DTC is activated.

Deactivating DTC

Press the button again: the DSC indicator lamps go out.

Deactivating both DTC and DSC



Press the button for at least 3 seconds: the DSC indicator lamps in the display elements come on. The Dynamic Traction Control DTC and Dynamic Stability Control DSC are both deactivated. There will be no more stabilizing interventions.

Interventions (differential lock*) in braking occur to improve propulsion when drive wheels are rotating unevenly, even when the DSC is deactivated.

Activating DSC

Press the button again: the indicator lamps go out.

Hill Assist

Hill Assist aids you in comfortably driving off on inclines. It is not necessary to use the parking brake for this.

1. Hold the MINI with the brake.
2. Release the brake and immediately drive off.

Hill Assist holds the car in place for approx. 2 seconds after the brake is released.

 Depending on the load and gradient, the vehicle can roll backward slightly during this period. After you release the brake, immediately start driving since the Hill Assist only holds the vehicle for about 2 seconds, and it will start to roll backwards. ◀

SPORT BUTTON*

Pressing the button causes your MINI to respond even more sportily.

- ▷ Engine responds more spontaneously to movements of the accelerator.
- ▷ Steering response is more direct.
- ▷ Cooper S, John Cooper Works: the engine sounds more sporty in coasting mode.

With automatic transmission:

- ▷ More rapid gear shifting in Sport program.

Activating the system



Press the SPORT button.
The LED lights up.

SPORT is briefly displayed in the tachometer.

Deactivating the system

- ▷ Press the SPORT button again.
- ▷ Switch off the engine.

FLAT TIRE MONITOR FTM

The concept

The Flat Tire Monitor detects pressure loss in a tire by comparing the rotating speeds of the individual tires while moving.

If a tire loses pressure, its rolling circumference changes, and this in turn alters the speed of rotation. This change is detected and is reported as a flat tire.

Functional requirement

In order to assure the reliable reporting of a flat tire, the system must be initialized for the correct tire inflation pressure.

 Each time you correct the pressure in a tire, or change a wheel or tire, the system must be reinitialized. ◀

System limitations

The Flat Tire Monitor is unable to warn the driver of sudden, severe tire damage caused by external factors, nor can it identify the gradual loss of pressure that will inevitably occur in all four tires over a lengthy period of time.

In the following situations, the system could be delayed or malfunction:

- ▷ System has not been initialized
- ▷ Driving on snowy or slippery road surface
- ▷ Performance-oriented style of driving: slip in the drive wheels, high lateral acceleration
- ▷ Snow chains are attached

When the vehicle is driven with a space-saver spare tire*, page 183, the Flat Tire Monitor cannot function.

Initializing the system

 The initialization is completed during driving, which can be interrupted at any time. When driving resumes, the initialization is continued automatically.

Do not initialize the system if you are driving with snow chains or a space-saver spare tire*. ◀

Using the onboard monitor

Onboard monitor, for operating principle refer to page 16.

1. Press the  button.
This opens the start menu.
2. Move the MINI joystick to highlight "Setup" and press the MINI joystick.

3. Select "Settings".

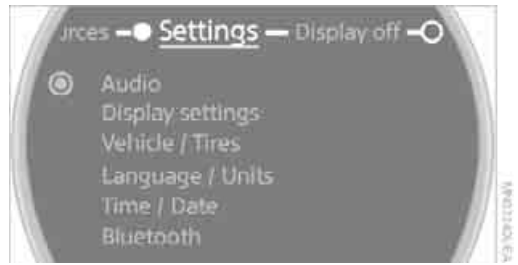

4. Select "Vehicle and tires".
5. If necessary, move the highlight marker to the uppermost field. Select "FTM".



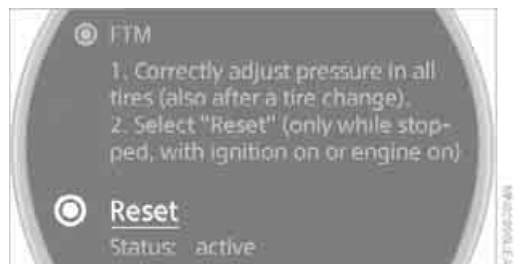

6. Start the engine, but do not start driving.
7. Select "Reset".



8. Select "Yes".
9. Start driving.
The initialization is completed during driving.

Indication of a flat tire

 The warning lamps come on in yellow and red. A message appears on the Control Display. An acoustic signal also sounds. There is a flat tire or substantial loss of tire pressure.



1. Reduce speed and stop the vehicle with caution. Avoid sudden braking and steering maneuvers.
2. Check whether your vehicle is equipped with normal tires or run-flat tires.

 The symbol identifying run-flat tires is a circle with the letters RSC on the sidewall, refer to Run-flat tires, page 165. ◀

Normal tires

1. Determine which tire is damaged.
 -  If this cannot be determined, contact your MINI dealer. ◀
2. Repair the flat tire, refer to page 180, or change the damaged tire, refer to page 183.

Run-flat tires*

1. Cautiously reduce speed to below 50 mph or 80 km/h. Avoid sudden braking and steering maneuvers. Do not exceed a speed of 50 mph or 80 km/h.

 Do not continue driving if the vehicle is not equipped with run-flat tires, page 165; otherwise, a serious accident could result. ◀

2. At the next opportunity, check the air pressure in all four tires.

 If all four tires are inflated to the correct pressures, the Flat Tire Monitor might not have been initialized. The system must then be initialized. ◀

3. In the event of complete tire pressure loss, 0 psi/0 kPa, you can estimate the possible distance for continued driving on the basis of the following guidelines:

- ▷ With a light load:
1 to 2 persons without luggage:
approx. 155 miles/250 km
- ▷ With a medium load:
2 persons, cargo bay full, or 4 persons without luggage:
approx. 94 miles/150 km
- ▷ With a full load:
4 persons, load compartment full:
approx. 30 miles/50 km

 Drive cautiously and do not exceed a speed of 50 mph or 80 km/h; otherwise, an accident may occur. In the event of pressure loss, vehicle handling changes. This includes reduced tracking stability in braking, extended braking distance and altered natural steering characteristics.

If unusual vibration or loud noises occur during the journey, this may be an indication that the damaged tire has finally failed. Reduce the vehicle speed and stop as soon as possible. Otherwise, sections of the tire may come loose and cause accidents. Do not continue driving and contact your MINI dealer. ◀

TIRE PRESSURE MONITOR TPM*

The concept

TPM checks the tire pressure in the four mounted tires during driving. The system notifies you if there is a significant loss of pressure in one or more tires.

Functional requirement

In order to assure the reliable reporting of a flat tire, the system must be reset while all tire inflation pressures are correct.

Always use wheels with TPM electronics. Otherwise, the system may malfunction.

 Each time a tire inflation pressure has been corrected or a wheel or tire has been changed, reset the system. ◀

System limitations

 TPM cannot warn you in advance of sudden severe tire damage caused by outside influences. ◀

The system does not work correctly if it has not been reset; for example, a flat tire may be indicated even though the tire inflation pressures are correct.

The system is inactive and cannot indicate a flat tire if a wheel without TPM electronics, such as a compact spare wheel*, has been mounted, or if

TPM is temporarily malfunctioning due to other systems or devices using the same radio frequency.

Status indicator on the onboard monitor

The tire and system condition is indicated by the color of the tires.

TPM takes into account the fact that tire pressure changes while the vehicle is being driven. The tire pressure does not need to be corrected unless the TPM instructs you to do so by means of color indicators.

Green

The tire inflation pressure corresponds to the established target value.

"TPM active" is displayed on the onboard monitor.

One wheel yellow

There is a flat tire or substantial loss of tire pressure in the indicated tire. A message appears on the onboard monitor.

All wheels yellow

There is a flat tire or substantial loss of tire pressure in several tires. A message appears on the onboard monitor.

Gray

The system cannot detect a puncture.

Possible reasons for this:

- ▷ TPM is being reset
- ▷ Temporary malfunction caused by systems or devices using the same radio frequency
- ▷ Malfunction

Resetting the system

▶ Each time a tire inflation pressure has been corrected or a wheel or tire has been changed, reset the system. ◀

Using the onboard monitor

Onboard monitor, for operating principle refer to page 16.

1. Press the  button. This opens the start menu.
2. Move the MINI joystick to highlight "Setup" and press the MINI joystick.
3. Select "Settings" and press the MINI joystick.



4. Select "Vehicle and tires" and press the MINI joystick.
5. If necessary, move the highlight marker to the uppermost field. Select "TPM" and press the MINI joystick.

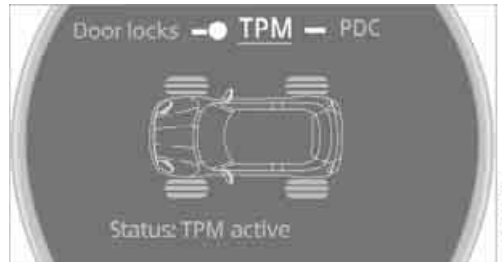

6. Start the engine, but do not start driving.
7. Select "Reset" and press the MINI joystick.
8. Select "Yes" and press the MINI joystick.

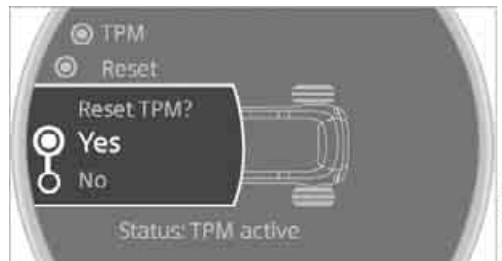

9. Start driving. The tires are shown in gray and "Resetting TPM..." is displayed.

After driving a few minutes, the set inflation pressures in the tires are accepted as the target values to be monitored. The system reset is completed during your drive, and can be interrupted at any time. When driving resumes, the reset is continued automatically. On the onboard monitor, the tires are shown in green and "Status: TPM active" is once again displayed.

 If a flat tire is detected while the system is being reset and while it is determining the inflation pressures, all tires on the onboard monitor are displayed in yellow. The message "Tire low!" is displayed. ◀

Message for low tire inflation pressure

 The warning lamps come on in yellow and red. A message appears on the onboard monitor. An acoustic signal also sounds. There is a flat tire or substantial loss of tire pressure.

1. Reduce speed and stop the vehicle with caution. Avoid sudden braking and steering maneuvers.
2. Check whether your vehicle is equipped with normal tires or run-flat tires.

 The symbol identifying run-flat tires is a circle with the letters RSC on the sidewall, page 165. ◀

Normal tires

1. Determine which tire is damaged.

 If this cannot be determined, contact your MINI dealer. ◀
2. Repair the flat tire or change the damaged tire, refer to page 183.

Run-flat tires*

1. Cautiously reduce speed to below 50 mph/80 km/h. Avoid sudden braking and steering maneuvers. Do not exceed a speed of 50 mph/80 km/h.

 Do not continue driving if the vehicle is not equipped with run-flat tires; otherwise, a serious accident could result. ◀

2. In the event of complete tire pressure loss, 0 psi/0 kPa, you can estimate the possible distance for continued driving on the basis of the following guidelines:

- ▷ With a light load:
1 to 2 persons without luggage:
approx. 155 miles/250 km
- ▷ With a medium load:
2 persons, cargo bay full, or 4 persons without luggage:
approx. 94 miles/150 km
- ▷ With a full load:
4 persons, load compartment full:
approx. 30 miles/50 km

 Drive cautiously and do not exceed a speed of 50 mph/80 km/h; otherwise, an accident may occur. In the event of pressure loss, vehicle handling changes. This includes reduced tracking stability in braking, extended braking distance and altered natural steering characteristics.

If unusual vibration or loud noises occur during the journey, this may be an indication that the damaged tire has finally failed. Reduce the vehicle speed and stop as soon as possible. Otherwise, sections of the tire may come loose and cause accidents. Do not continue driving and contact your MINI dealer. ◀

Malfunction

 The small warning lamp flashes in yellow and then lights up continuously; the larger warning lamp comes on in yellow.

On the onboard monitor, the tires are shown in gray and a message appears. No punctures can be detected.

This type of message is shown in the following situations:

- ▷ If there is a malfunction.
Have the system checked.
- ▷ If a wheel without TPM electronics has been mounted.
- ▷ If TPM is temporarily malfunctioning due to other systems or devices using the same radio frequency.

Message for unsuccessful system reset



Both warning lamps come on in yellow.



A message appears on the onboard monitor. The system is not reset after a tire has been changed, for example.

Check the tire inflation pressure and reset the system, page 76.

Declaration according to NHTSA/ FMVSS 138 Tire Pressure Monitoring Systems

Each tire, including the spare, should be checked monthly when cold and inflated to the inflation pressure recommended by the vehicle manufacturer on the vehicle placard or tire inflation pressure label. If your vehicle has tires of a different size than the size indicated on the vehicle placard or tire inflation pressure label, you should determine the proper tire inflation pressure for those tires. As an added safety feature, your vehicle has been equipped with a tire pressure monitoring system TPMS that illuminates a low tire pressure telltale when one or more of your tires are significantly underinflated.

Accordingly, when the low tire pressure telltale illuminates, you should stop and check your tires as soon as possible, and inflate them to the proper pressure. Driving on a significantly underinflated tire causes the tire to overheat and can lead to tire failure. Underinflation also reduces fuel efficiency and tire tread life, and may affect the vehicle's handling and stopping ability. Please note that the TPMS is not a substitute for proper tire maintenance, and it is the driver's responsibility to maintain correct tire pressure, even if underinflation has not reached the level at which the TPMS low tire pressure telltale illuminates.

The TPMS malfunction indicator is combined with the low tire pressure telltale. When the system detects a malfunction, the telltale will flash for approximately one minute and then remain continuously lit. This sequence will continue upon subsequent vehicle startups as long as the malfunction exists. When the malfunction indicator is illuminated, the system may not be able to detect or signal low tire pressure as intended. TPMS malfunctions may occur for a variety of

reasons, including the installation of replacement or alternate tires or wheels on the vehicle that prevent the TPMS from functioning properly. Always check the TPMS malfunction telltale after replacing one or more tires or wheels on your vehicle to ensure that the replacement or alternate tires and wheels allow the TPMS to continue to function properly.

AIRBAGS

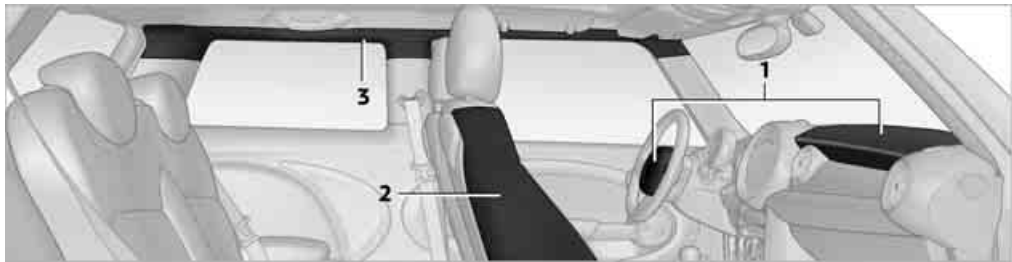

The following airbags are located under the marked covers:

- 1 Front airbags
- 2 Side airbags in backrests
- 3 Head airbags at the front and rear

Protective effect

 Observe the instructions on page 37 to ensure the best possible personal protection. ◀

The front airbags help protect the driver and front passenger by responding to frontal impacts in which safety belts alone cannot provide adequate restraint. When needed, the head and side airbags help provide protection in the event of side impact. The relevant side airbag supports the side upper body area. The head airbag supports the head.

The airbags are designed to not be triggered in every type of collision, e.g. not in minor accidents, certain rollover situations or rear impacts.

 Do not apply adhesive materials to the cover panels of the airbags, cover them or modify them in any other way.

Keep the dashboard and window on the passenger side free from obstruction, i.e. do not cover it with adhesive film or coverings, and do not affix any holders such as for a navigation device or a mobile phone.

Do not attach seat covers, cushions or other objects not specifically approved for seats with integral side airbags to the front seats. Do not hang items of clothing such as coats or jackets over the backrests. Do not attempt to remove the airbag retention system from the vehicle. Do not modify the individual components of the system or its wiring in any way. This includes the upholstered covers on the steering wheel,

instrument panel, seats and roof posts, as well as the sides of the roof lining. Do not attempt to remove or dismantle the steering wheel.

Do not touch the individual components immediately after the system has been triggered, because there is a danger of burns.

In the event of malfunctions, deactivation, or triggering of the airbag restraint system, have the testing, repair, removal, and disposal of airbag generators executed only by a MINI dealer or a workshop that works according to repair procedures of the manufacturer of your MINI with correspondingly trained personnel and has the required explosives licenses. Otherwise, unprofessional attempts to service the system could lead to failure in an emergency or undesired airbag activation, either of which could result in personal injury. ◀

Warning notices and information about the airbags can also be found on the sun visors.

Automatic deactivation of the front passenger airbags

An analysis of the impression in the front passenger seat cushion determines whether and how the seat is occupied. The front and side airbags for the front passenger are activated or deactivated by the system accordingly.

 The indicator lamp above the interior rear-view mirror shows the current status of the front passenger airbags, deactivated or activated, refer to Status of front passenger airbags below. ◀

 Before transporting a child on the front passenger seat, read the safety precautions and handling instructions under Transporting children safely, page 43.

The front and side airbags can also be deactivated by adolescents and adults sitting in certain positions; the indicator lamp for the front passenger airbags comes on. In such cases, the passenger should change his or her sitting position so that the front passenger airbags are activated and the indicator lamp goes out. If the desired airbag status cannot be achieved by changing the sitting position, transport the relevant passenger on a rear seat. Do not attach covers, cushions, ball mats or other items to the front passenger seat unless they are specifically recommended by the manufacturer of your MINI. Do not place any items under the seat which could press against the seat from below. Otherwise, a correct analysis of the seat cushion is not ensured. ◀

Status of front passenger airbags



The indicator lamp for the front passenger airbags shows the functional status of the front passenger's front and side airbags in accordance with whether and how the front passenger seat is occupied. The indicator lamp shows whether the front passenger airbags are activated or deactivated.

- ▷ The indicator lamp comes on as intended when a child in a specially designated child restraint system is detected on the seat.

The front and side airbags for the front passenger are not activated.

 Most child seats are detected by the system. This particularly applies to child seats that were required by the NHTSA at the time of manufacture of the vehicle. After installing a child seat, check that the indicator lamp for the front passenger airbags comes on. It indicates that the child seat has been detected and that the front passenger airbags are deactivated. ◀

- ▷ The indicator lamp does not come on as long as a person of sufficient size and in a correct sitting position is detected on the seat. The front and side airbags for the front passenger are activated.
- ▷ The indicator lamp does not come on if the seat is empty. The front and side airbags for the front passenger are not activated.

Operational readiness of airbag system



As of radio readiness, page 46, the warning lamp comes on briefly to indicate that the entire airbag system and the belt tensioners are operational.

Airbag system malfunction

- ▷ The warning lamp does not come on when radio readiness or the ignition is switched on.
- ▷ The warning lamp stays lit continuously.

 In the event of a fault in the airbag system, have it checked without delay; otherwise, there is the risk that the system will not function as intended even if a severe accident occurs. ◀

LAMPS

PARKING LAMPS/LOW BEAMS

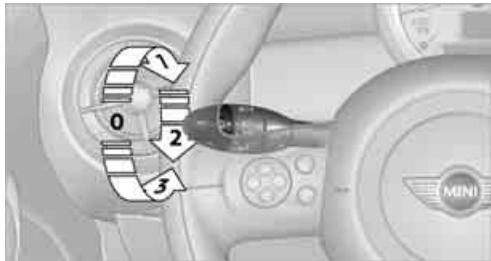

- 0 Lamps off and daytime running lights
- 1 Parking lamps and daytime running lights
- 2 Low-beam headlamps and welcome lamps
- 3 Automatic headlamp control*, daytime running lights and welcome lamps

When you open the driver's door with the ignition switched off, the exterior lighting is automatically switched off if the light switch is in position 0, 2 or 3.

Switch on the parking lamps if necessary, switch position 1.

Parking lamps

Turn the light switch to position 1. The front, rear and side vehicle lighting is switched on.

Activation of lights on one side of the vehicle for parking, page 82.



The parking lamps will discharge the battery. Therefore, do not leave them on for unduly long periods of time; otherwise, the battery might not have enough power to start the engine. ◀

Low beams

Turn the light switch to position 2. The low beams come on when the ignition is on.

Automatic headlamp control*

When the switch is in position 3, the low beams are switched on and off automatically depending on ambient light conditions, e.g. in a tunnel, in twilight, or if there is precipitation.

The headlamps may also come on when the sun is sitting low on a blue sky.

When driving into tunnels with bright overhead lights, there may be a delay before the headlamps come on.

The low beams remain switched on independent of the ambient lighting conditions when you switch on the fog lamps*.

If the daytime running lights are activated, page 82, the low beams are always switched on with the light switch in position 3 and the ignition on. The exterior lamps are automatically switched off after the vehicle is parked.



The automatic headlamp control cannot serve as a substitute for your personal judgment in determining when the lamps should be switched on in response to ambient lighting conditions. For example, the system cannot detect fog or hazy weather. To avoid safety risks, you should respond to these kinds of low-visibility situations by switching the headlamps on manually. ◀

Welcome lamps

If you leave the light switch in the low beam or automatic headlamp control position when you switch off the ignition, the parking lamps and interior lamps come on for a certain time as soon as the vehicle is unlocked.

Pathway lighting

If you activate the headlamp flasher after switching off the ignition with the lamps switched off, the low beams come on and remain on for a certain time.

The setting is stored for the remote control in use, refer to Personal Profile, page 26.

Setting the duration or deactivating the function

1. Press the  button.
This opens the start menu.
2. Move the MINI joystick to highlight "Setup" and press the MINI joystick.
3. Select "Settings".
4. Select "Vehicle and tires".
5. Select "Lighting".



6. Select "Pathway lighting".
7. Turn the MINI joystick to select the corresponding duration.
8. Press the MINI joystick to apply the setting.

Daytime running lights*

The light switch can remain in the lamps off, parking lamps or automatic headlamp control* position.

In the lamps off position, the exterior lighting is automatically switched off after the vehicle is parked. In the parking lamps position, the parking lamps will stay on after the ignition is switched off.

Switch on the parking lamps separately if needed.

Activating/deactivating daytime running lights

The setting is stored for the remote control in use, refer to Personal Profile, page 26.

1. Press the  button.
This opens the start menu.
2. Move the MINI joystick to highlight "Setup" and press the MINI joystick.
3. Select "Settings".

4. Select "Vehicle and tires".
5. Select "Lighting".



6. Select "Daytime running lamps".
 The daytime running lights are switched on.

HIGH BEAMS/ROADSIDE PARKING LAMPS

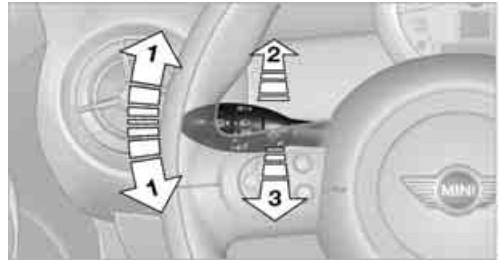

- 1 Turn signal indicators/roadside parking lamps*
- 2 Switching on high beams
- 3 Switching off high beams/headlamp flasher

Roadside parking lamps, left or right*

The vehicle can be illuminated on one side for parking. Comply with local regulations when doing so.

Switching on

After parking the vehicle, press the lever up or down, arrow 1.

-  The roadside parking lamps drain the battery. Therefore, do not leave them on for unduly long periods of time; otherwise, the battery might not have enough power to start the engine. ◀

Switching off

Press the lever up or down to the pressure point.

FOG LAMPS*

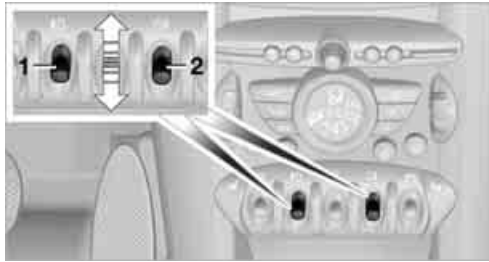

- 1 Fog lamps*
- 2 Rear fog lamp*

Press the respective switch to turn the lamps on/off.

Fog lamps*

The parking lamps or low beams must be switched on for the fog lamps to operate. The green indicator lamp comes on when the fog lamps are switched on.

Depending on your vehicle's equipment, the fog lamps are switched off when you activate the headlamp flasher or switch on the high beams.

 If the automatic headlamp control is activated, the low beams will come on automatically when you switch on the fog lamps. ◀

Rear fog lamp*

The low beams or parking lamps with fog lamps must be switched on. The yellow indicator lamp comes on when the rear fog lamp is switched on.

INSTRUMENT LIGHTING

You can adjust the brightness of the instrument lighting only when the parking lamps or the low beams are on.



Increasing brightness

Press and hold the button until the desired brightness is reached.

Reducing brightness

Press the button briefly.

The brightness decreases every time the button is pressed briefly.

INTERIOR LAMPS

The interior lamps, the footwell lamps* and the cargo bay lamp are controlled automatically.

 To avoid draining the battery, all lamps inside the car are switched off about 8 minutes after the ignition is switched off, refer to Start/stop button on page 46. ◀

Switching interior lamps on/off manually

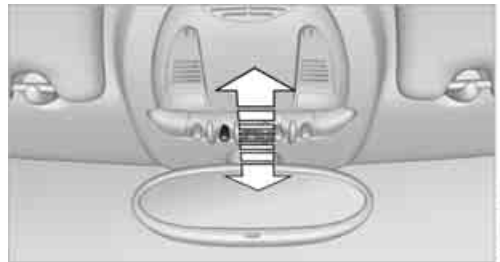

To switch the interior lamps on/off.

Press the switch.

To switch off the interior lamps permanently, press the button for about 3 seconds.

Reading lamps*

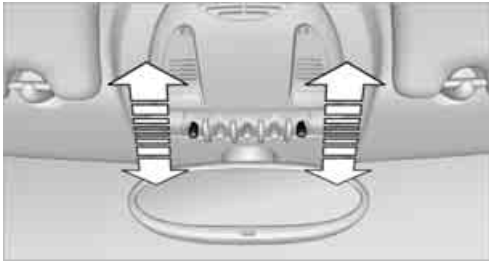

To switch the reading lamps on and off.
Press the switch.

Ambient lighting*

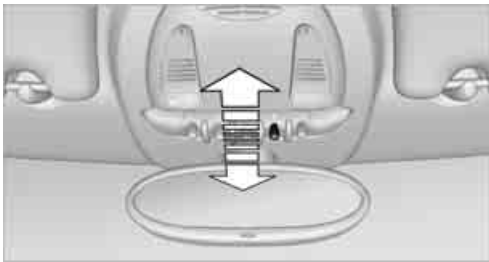

The color of the ambient lighting can be changed.

- ▷ Press the switch forward.
The color changes in stages, ultimately to orange.
- ▷ Press the switch toward the rear.
The color changes in stages, ultimately to blue.

Intermediate settings and colors are possible.

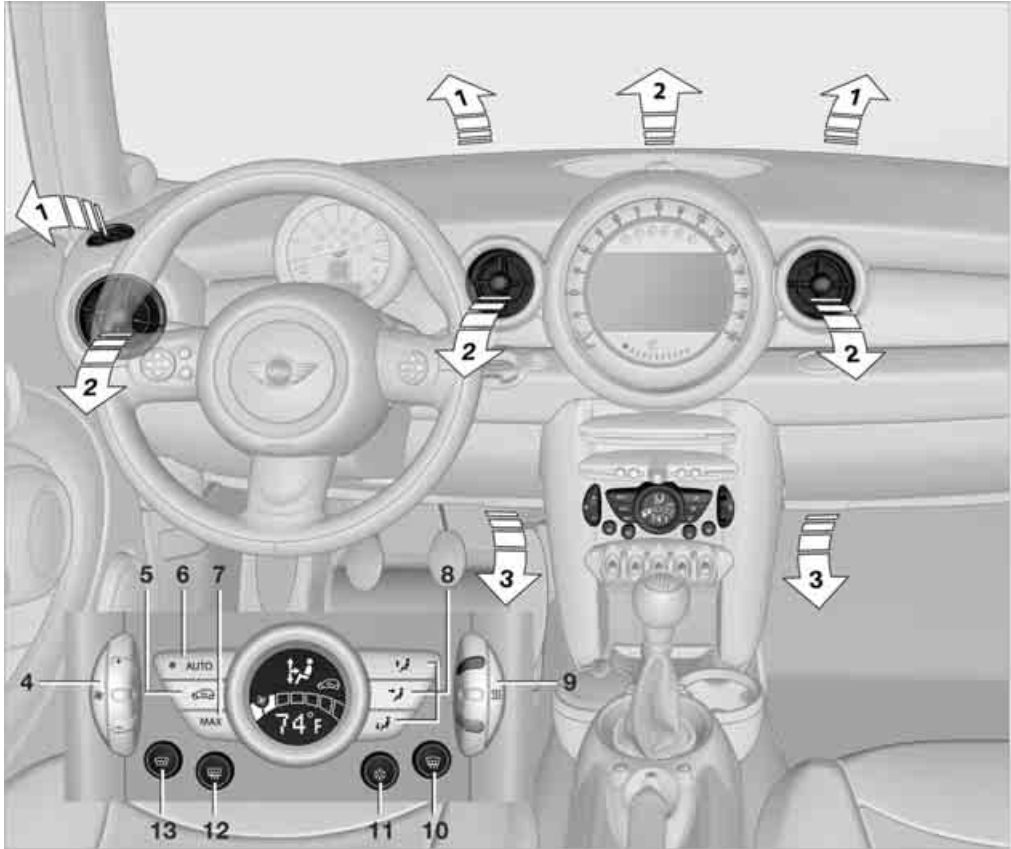

- 1 Airflow directed toward the windshield and side windows
- 2 Air to the upper body area
Draft-free ventilation [87](#)
- 3 Air to the footwell
- 4 Air flow rate, manual
- 5 Recirculated-air mode
- 6 AUTO program
- 7 Maximum cooling
- 8 Air distribution, manual
- 9 Setting the temperature
- 10 Defrosting windows and removing condensation
- 11 Manual cooling function
- 12 Rear window defroster
- 13 Windshield heating*

AUTOMATIC CLIMATE CONTROL

Comfortable interior climate

AUTO program **6** offers the ideal air distribution and air flow rate for almost all conditions, refer to AUTO program below. All you need to do is select an interior temperature which is comfortable for you.

The following sections inform you in detail about how to adjust the settings.

Most settings are stored for the remote control currently in use, refer also to Personal Profile settings on page 26.

Air flow rate, manual



Press the – button to reduce air flow. Press the + button to increase it.

You can reactivate the automatic mode for the air flow rate with the AUTO button.

The air flow rate is lowered or switched off entirely to save on battery power. The display remains the same.

Switching the system on/off

Reduce the air flow by pressing the – button repeatedly until the system is switched off. All indicators go out.

Press the AUTO button to switch the automatic climate control back on.

AUTO program



The AUTO program adjusts the air distribution to the windshield and side windows, towards the upper body area and into the footwell for you. The air flow rate and your temperature specifications will be adapted to outside influences in accordance with seasonal changes, e.g. sunlight.

The cooling function is automatically switched on along with the AUTO program.

Recirculated-air mode



Recirculated-air mode: the supply of outside air is permanently shut off. The system then recirculates the air currently within the vehicle.



If condensation starts to form on the inside window surfaces, press the AUTO button or switch off the recirculated-air mode and, if necessary, increase the air flow rate. The recirculated-air mode should not be used over an extended period of time; otherwise, the air quality inside the car will deteriorate continuously. ◀

Maximum cooling



At outside temperatures above 32 °F / 0 °C and when the engine is running, you obtain a maximum cooling effect as soon as possible.

The automatic climate control goes into recirculated-air mode at the lowest temperature. Air flows at maximum rate from the vents for the upper body area. You should therefore open them for maximum cooling.

Air distribution, manual



The flow of air is directed to the windows, to the upper body area or to the footwell as selected.

You can switch the automatic air distribution back on by pressing the AUTO button.

Temperature



Set the desired temperature individually.

The automatic climate control achieves this temperature as quickly as possible regardless of the season, using maximum cooling or heating power if necessary, and then maintains it.



If you switch between different temperature settings in quick succession, the automatic climate control does not have enough time to achieve the set temperature. ◀

Rear window defroster



The defroster is switched off automatically after a certain time. Depending on your vehicle's equipment, the upper wires serve as an antenna and are not part of the rear window defroster.

Defrosting windows and removing condensation



Quickly removes ice and condensation from the windshield and front side windows. For this purpose, also switch on the cooling function. The windshield heating* is switched on automatically.

Windshield heating*



The windshield heating is switched off automatically after a certain time.

Cooling function

The passenger compartment can only be cooled while the engine is running.



When the cooling function is on, the air is cooled, dried, then reheated according to the temperature setting.

The cooling function helps prevent condensation on the windows or removes it quickly.

Depending on the weather, the windshield may fog over briefly when the engine is started. The recirculated-air mode may be switched on automatically.

When the AUTO button is pressed, the cooling function switches on automatically.

Microfilter/activated-charcoal filter

The microfilter captures dust and pollen. The activated-charcoal filter provides additional protection by filtering gaseous pollutants from the outside air. Your MINI dealer replaces this com-

posed filter as a standard part of your scheduled maintenance.

You can call up further information in the service requirements display, page 60.

VENTILATION

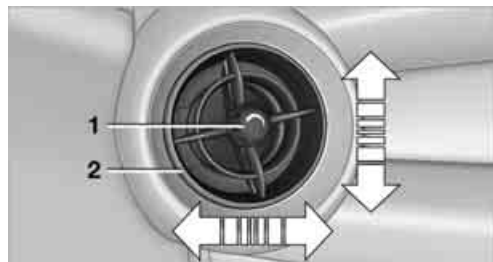

- 1 Knob for continuous opening and closing
- 2 Jet for direction of air flow

Opening/closing

Turn the knob.

Direction of air flow

Swivel the entire jet.

PRACTICAL INTERIOR ACCESSORIES

INTEGRATED UNIVERSAL REMOTE CONTROL*

The concept

The integrated universal remote control can replace as many as three hand-held transmitters for various remote-controlled devices, such as garage and gate openers and lighting systems. The integrated universal remote control registers and stores signals from the original hand-held transmitters.

The signal of an original hand-held transmitter can be programmed on one of the three memory buttons 1. The system in question can then be operated by means of the programmed memory button 1. The LED 2 flashes to confirm transmission of the signal.

If you decide to sell your vehicle one day, in the interest of your own security, remember to clear the stored programs before the vehicle leaves your possession, page 89.

 To prevent possible damage or injury, before programming or using the integrated universal remote control, always inspect the immediate area to make certain that no people, animals or objects are within the pivoting or travel range of the device being operated. Comply also with the safety instructions supplied with the original hand-held transmitter. ◀

Checking compatibility



If this symbol appears on the package or in the instructions supplied with the original hand-held transmitter, you can assume that the radio remote control device is compatible with the integrated universal remote control.

For additional information, please contact your MINI dealer or call: 1-800-355-3515.

You can also obtain information on the Internet at:

www.MINI.com or

www.homelink.com

HomeLink is a registered trademark of Johnson Controls, Inc.

Programming



- 1 Memory buttons
- 2 LED

Fixed-code hand-held transmitters

1. Switch on the ignition, page 46.
2. When starting operation for the first time: Press both outer memory buttons 1 for approx. 20 seconds until the LED 2 flashes rapidly. All stored programs are cleared.
3. Hold the original hand-held transmitter at a distance of approx. 2 in to 12 in/5 to 30 cm from the memory buttons 1.



The required distance between the hand-held transmitter and the memory buttons 1 depends on the system of the respective original hand-held transmitter used. ◀

4. Simultaneously press the transmit key on the original hand-held transmitter and the desired memory button 1 on the integrated universal remote control. The LED 2 flashes slowly at first. As soon as the LED 2 flashes rapidly, release both buttons. If the LED 2 does not flash rapidly after approx. 15 seconds, alter the distance.
5. To program other original hand-held transmitters, repeat steps 3 and 4.

The corresponding memory button **1** is now programmed with the signal of the original hand-held transmitter.

You can operate the system with the engine running or with the ignition switched on.

 If the system fails to function even after repeated programming, check whether the original hand-held transmitter uses an alternating-code system. To do so, either read the instructions for the original hand-held transmitter or hold down the programmed memory button **1** of the integrated universal remote control. If the LED **2** on the integrated universal remote control flashes rapidly and then remains lit for about two seconds, the original hand-held transmitter uses an alternating-code system. If it uses an alternating-code system, program the memory buttons **1** as described under Alternating-code hand-held transmitters. ◀

Alternating-code hand-held transmitters

To program the integrated universal remote control, consult the operating instructions for the device to be set. You will find information there on the possibilities for synchronization or programming of additional hand-held transmitters.

When programming hand-held transmitters that employ an alternating code, please observe the following supplementary instructions:

 Programming will be easier with the aid of a second person. ◀

1. Park your vehicle within the range of the remote-controlled device.
2. Program the integrated universal remote control as described above in the section Fixed-code hand-held transmitters.
3. Locate the button on the receiver of the device to be set, e.g. on the drive unit.
4. Press the button on the receiver of the device to be set. After step 4, you have approx. 30 seconds for the next step 5.
5. Press the programmed memory button **1** of the integrated universal remote control three times.

The corresponding memory button **1** is now programmed with the signal of the original hand-held transmitter.

Clearing stored programs

Press both outer memory buttons **1** for approx. 20 seconds until the LED **2** flashes: all stored programs are cleared.

It is not possible to clear individual programs.

Reassigning individual programs

1. Hold the original hand-held transmitter at a distance of approx. 2 in to 12 in/5 to 30 cm from the memory buttons **1**.

 The required distance between the hand-held transmitter and the memory buttons **1** depends on the system of the respective original hand-held transmitter used. ◀

2. Press the desired memory button **1** of the integrated universal remote control.
3. If the LED **2** flashes slowly after approx. 20 seconds, press the transmit key of the original hand-held transmitter and release both buttons as soon as the LED **2** flashes rapidly.

If the LED **2** does not flash rapidly after approx. 15 seconds, alter the distance and repeat this step.

GLOVE COMPARTMENT

Opening

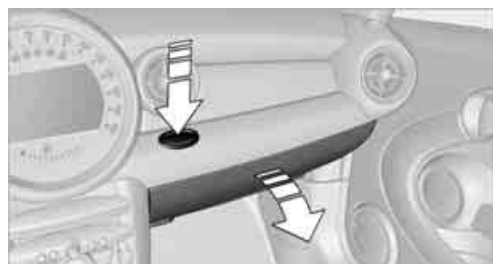

Press the button to open the cover.
The light in the glove compartment comes on.

Closing

Fold cover up.

⚠ To prevent injury in the event of an accident, close the glove compartment after use while the vehicle is being driven. ◀

Ventilation*

Depending on your vehicle's equipment, the glove compartment can be ventilated and, if the cooling function* is switched on, can also be cooled.

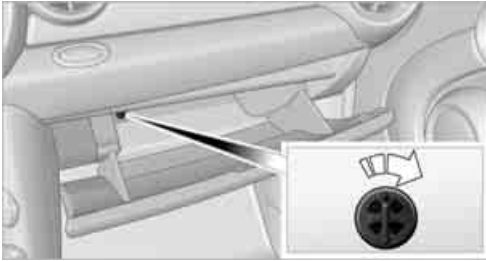

Opening

Rotate the switch in the direction of the arrow.

Closing

Rotate the switch in the opposite direction of the arrow until it is in the vertical position.

Depending on the temperature setting of the air conditioning or the automatic climate control, high temperatures may result in the glove compartment.

CENTER ARMREST*

Storage compartment

The center armrest between the front seats contains either a compartment or the cover for the mobile phone base plate* or the snap-in adapter*.



Opening

The cover slides along guide rails and can be opened fully by pushing it back and lifting it.

Closing

Push the cover forwards.

CONNECTION FOR EXTERNAL AUDIO DEVICE

You can connect an external audio device such as a CD or MP3 player and play audio recordings over the vehicle speakers.

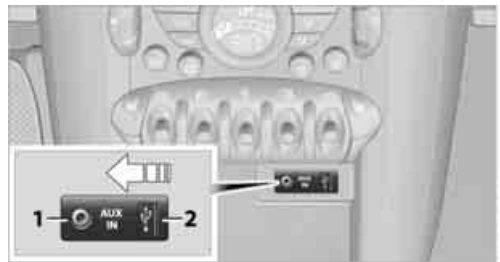

- ▷ AUX-IN port, refer to page 149
- ▷ USB audio interface*, refer to page 150

STORAGE COMPARTMENTS

In the vehicle interior

Depending on your vehicle's equipment, you will find storage compartments in the doors, next to the rear seats and in the center console*. Nets* are located in the passenger footwell and on the backs of the front seat backrests.

Storage compartment on the front passenger side*

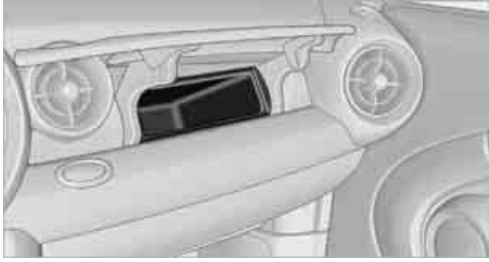

Opening

Briefly press the bottom edge of the cover.

Closing

Push the cover back into its original position.

 To prevent injury in the event of an accident, close the storage compartment after use while the vehicle is being driven. ◀

Clothes hooks

There are clothes hooks on the grab handles in the rear passenger compartment.

 Items of clothing hung from the hooks must not obstruct the driver's view. Do not hang heavy objects from the hooks; otherwise, they could endanger the car's occupants, e.g. in case of heavy braking or sudden swerving. ◀

In the cargo bay

Depending on your vehicle's equipment, you have the following storage options:

- ▷ Umbrella holder* under the loading sill in front of the warning triangle
- ▷ Storage compartment under the level load floor*
- ▷ Removable box with lid* under the level load floor, e.g. for wet or dirty items
- ▷ Storage compartment in the splitdoor
- ▷ Net* on the cargo bay floor for smaller objects; for attaching to the lashing eyes

CUPHOLDERS AND ASHTRAY*



Cupholders

Two cupholders are located in the front of the center console; another is in the rear at the back of the center console.

There are two additional cupholders in the arm rests in the rear.



 Do not place glass containers in the cupholders, as this increases the risk of injury in the event of an accident. ◀

Ashtray*

The ashtray is located in one of the cupholders in the center console.

Emptying

Remove the entire ashtray.

Lighter



With the engine running or the ignition switched on, press in the cigarette lighter.

The lighter can be pulled out as soon as it pops back out.

⚠ Hold or touch the hot cigarette lighter by the knob only. Holding or touching it in other areas could result in burns. When leaving the car, always remove the key so that children cannot operate the cigarette lighter and burn themselves. ◀

CONNECTING ELECTRICAL APPLIANCES

In your MINI, you can use electrical devices such as a flashlight, car vacuum cleaner, etc., up to approx. 200 watts at 12 volts, as long as one of the following sockets is available. Avoid damaging the sockets by attempting to insert plugs of unsuitable shape or size.

Cigarette lighter socket

Remove the lighter* or cover from the socket.

Power socket in cargo bay



By way of example, the illustration shows the cargo bay in the MINI.

Pull out the cover.



AT A GLANCE

CONTROLS

DRIVING TIPS

NAVIGATION

ENTERTAINMENT

MOBILITY

REFERENCE

THINGS TO REMEMBER WHEN DRIVING

BREAK-IN PERIOD

Moving parts need breaking-in time to adjust to each other. Please follow the instructions below in order to achieve the optimal service life and economy of operation for your vehicle.

Engine and differential

Always obey all official speed limits.

Up to 1,200 miles/2,000 km

Drive at varying engine and road speeds, but do not exceed the following:

- ▷ Gasoline engine
4,500 rpm or 100 mph/160 km/h

Avoid full-throttle operation and use of the transmission's kickdown mode.

After driving 1,200 miles/2,000 km

Engine and vehicle speeds can be gradually increased.

Tires

Due to technical factors associated with their manufacture, tires do not achieve their full traction potential until after an initial break-in period. Therefore, drive cautiously during the first 200 miles/300 km.

Brake system

Brakes require an initial break-in period of approx. 300 miles/500 km to achieve optimized contact and wear patterns between brake pads and rotors. Drive cautiously during this break-in period.

Clutch

The function of the clutch reaches its optimal level only after a distance driven of approx. 300 miles/500 km. During this break-in period, engage the clutch gently.

Following part replacement

The same break-in procedures should be observed if any of the components mentioned above have to be renewed in the course of the vehicle's operating life.

GENERAL DRIVING NOTES

Close splitdoor

 Drive the vehicle only when the splitdoor is closed. Otherwise, exhaust fumes could penetrate the interior of the vehicle. ◀

If special circumstances make it absolutely necessary to drive with the splitdoor open:

1. Close all windows and the glass sunroof*.
2. Switch off the recirculated-air mode and significantly increase the air flow rate of the automatic climate control, page 86.

Hot exhaust system

 In all vehicles, extremely high temperatures are generated in the exhaust system. Do not remove the heat shields installed adjacent to various sections of the exhaust system, and never apply undercoating to them. When driving, standing at idle and while parking, take care to avoid possible contact between the hot exhaust system and any highly flammable materials such as hay, leaves, grass, etc. Such contact could lead to a fire, with the risk of serious personal injuries and property damage. Do not touch hot exhaust tail pipes. Otherwise, there is a risk of burns. ◀

Hydroplaning

 When driving on wet or slushy roads, reduce road speed. If you do not, a wedge of water can form between tires and road surface. This situation, known as hydroplaning, can cause partial or complete loss of tire contact with the road surface, so that the car cannot be steered or braked properly. ◀

The risk of hydroplaning increases with declining tread depth on the tires, refer also to Tread depth on page 164.

Driving through water

 Drive through water on the road only if it is not deeper than 1 ft/30 cm, and then only at walking speed at the most. Otherwise, the vehicle's engine, the electrical systems and the transmission may be damaged. ◀

Parking brake on inclines

 On inclines, do not hold the vehicle with the clutch; use the parking brake. Otherwise, greater clutch wear will result. ◀

For information on driving off using Hill Assist*, refer to page 73.

Braking safely

Your MINI is equipped with ABS. If you are in a situation which requires full braking, it is best to brake using maximum brake pressure. Since the vehicle maintains steering responsiveness, you can still avoid possible obstacles with a minimum of steering effort.

The pulsation of the brake pedal, together with the sound of hydraulic regulation, indicates that ABS is actively taking effect.

Driving in wet conditions

When roads are wet or there is heavy rain, briefly exert gentle pressure on the brake pedal every few miles. Monitor traffic conditions to ensure that this maneuver does not endanger other road users. The heat generated in this process helps dry the pads and rotors to ensure that Then full braking force will be immediately available when it is needed.

Hills

 To prevent overheating and the resulting reduced efficiency of the brake system, drive long or steep downhill gradients in the gear in which the least braking is required. Even light but consistent brake pressure can lead to high temperatures, brake wear and possibly even brake failure. ◀

You can increase the engine's braking effect by shifting down, all the way to first gear if necessary. This strategy helps you avoid placing excessive loads on the brake system. Downshifting in manual mode of the automatic transmission, page 49.

 Never drive with the clutch held down, with the transmission in neutral or with the engine switched off; otherwise, engine braking action will not be present or there will be no power assistance to the brakes or steering. Never allow floor mats, carpets or any other objects to protrude into the area around the pedals; otherwise, pedal function could be impaired. ◀

Corrosion on brake rotors

When the vehicle is driven only occasionally, during extended periods when the vehicle is not used at all, and in operating conditions where brake applications are less frequent, there is an increased tendency for corrosion to form on rotors, while contaminants accumulate on the brake pads. This occurs because the minimum pressure which must be exerted by the pads during brake applications to clean the rotors is not reached.

Should corrosion form on the brake rotors, the brakes will tend to respond with a pulsating effect that even extended application will fail to cure.

When the vehicle is parked

Condensation forms while the automatic climate control is in operation, and then exits under the vehicle. Traces of condensed water under the vehicle are therefore normal.

In the MINI Cooper S, the coolant pump may continue to run for some time after the engine is switched off. This will generate noise in the engine compartment.

CARGO LOADING

⚠ To avoid loading the tires beyond their approved carrying capacity, never overload the vehicle. Overloading can lead to overheating and increases the rate at which damage develops inside the tires. The ultimate result can assume the form of a sudden blowout. ◀

⚠ Avoid fluid spills in the cargo bay as they could damage the vehicle. ◀

Cargo bay cover

⚠ Do not place any objects on the cover; otherwise, they could endanger the car's occupants, e.g. in the case of braking or sudden swerving, or they may damage the cover. ◀

The cargo bay cover can be locked in intermediate positions **1** to **3**.

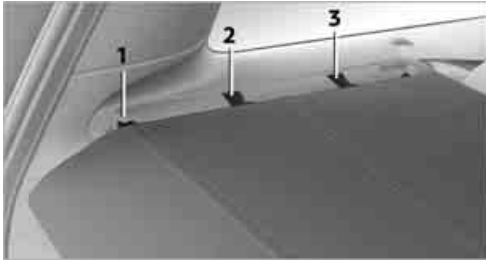

To load bulky luggage, the cover can be removed.

1. Pull on the handle, arrow **1**, to detach the cargo bay cover.



2. Lift the cargo bay cover up out of the holders, arrows **2**.

Expanding the cargo bay

The rear set backrest is split. Both sides can be folded separately to expand the cargo bay.

If necessary, remove the third head restraint, refer to Head restraints, Removing page **39**.

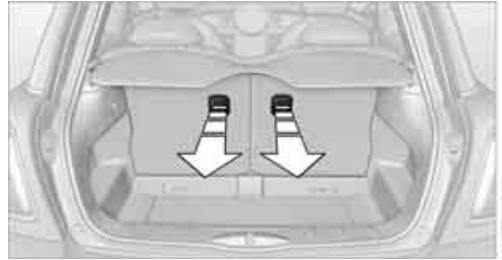

By way of example, the illustration shows the cargo compartment in the MINI.

1. Pull the lever.
2. Fold rear seat backrests forward.

⚠ When folding the backrest back up, make sure that the seat's locking mechanisms engage properly. Otherwise, cargo could be thrown around in the event of sharp braking or swerving and endanger the occupants. ◀

Adjusting rear seat backrest*

Expand the cargo bay by raising the split rear seat backrests to a steeper angle.



By way of example, the illustration shows the cargo compartment in the MINI.

1. Pull the lever, arrow **1**, and fold the rear seat backrest forward.
2. Fold up the lever of the backrest lock until it audibly engages, arrow **2**.
3. Fold back the backrest until it engages.

 If the rear seat backrests are positioned at a steeper angle, do not install child-restraint systems in the rear of the vehicle as their protective features may be ineffective. ◀

Partition net*

 Ensure that the partition net is firmly attached; otherwise, injuries may occur. ◀

The partition net can be mounted in the cargo bay or behind the front seats.

In the cargo bay

1. Fold the rear seat backrest forward if necessary, page 98.

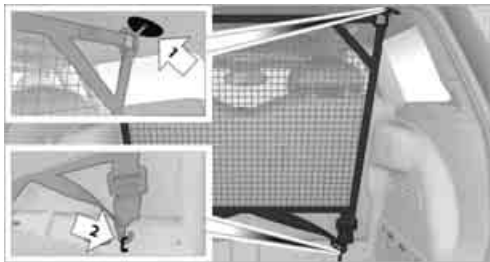

2. Insert each partition net mounting pin all the way into its respective rear mount in the headliner, arrow 1, and push it forward.
3. Hang the hooks of the partition net into the eyelets on the cargo bay floor, arrow 2.

Behind the front seats

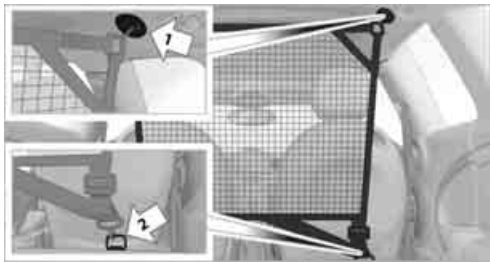

1. Fold down the rear seat backrests, refer to Expanding the cargo bay.
2. Insert each partition net mounting pin all the way into its respective front mount in the headliner, arrow 1, and push it forward.

3. Fold up the eyelets on the rear seat and hook the partition net into them, arrow 2.

Level load floor*

 The maximum load of the level load floor is 165 lbs/75 kg. Do not exceed a maximum permissible load of 55 lbs/25 kg for the storage compartment beneath the level load floor; otherwise, damage can occur. ◀



Raise the level load floor and fold it up toward the front, arrow.

Removing

1. Fold up the level load floor.
2. Pull the load floor back slightly.
3. Then take it out toward the top.

Determining cargo limit



1. Locate the following statement on your vehicle's placard*:

 The combined weight of occupants and cargo should never exceed XXX kg or YYY lbs. Otherwise, the vehicle may be damaged and unstable driving conditions may result. ◀

2. Determine the combined weight of the driver and passengers that will be riding in your vehicle.
3. Subtract the combined weight of the driver and passengers from XXX kilograms or YYY pounds.
4. The resulting figure equals the available amount of cargo and luggage load capacity. For example, if the XXX amount equals 1,400 lbs and there will be four 150 lbs passengers in your vehicle, the amount of available cargo and luggage load capacity is 650 lbs:
1,400 lbs minus 750 lbs = 650 lbs.
5. Determine the combined weight of luggage and cargo being loaded on the vehicle. That weight may not safely exceed the available cargo and luggage load capacity calculated in step 4.
6. If your vehicle will be towing a trailer, part of the load from your trailer will be transferred to your vehicle. Consult the manual for transporting a trailer to determine how this may reduce the available cargo and luggage load capacity of your vehicle.

Load

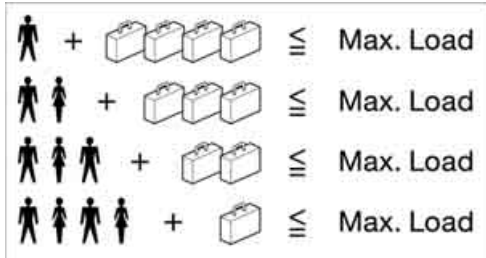

The permissible load is the sum of the occupants' weights and the weight of the cargo. The greater the weight of the occupants, the less cargo/luggage can be transported.

Stowing cargo

- ▷ Position heavy objects as low and as far forward as possible, ideally directly behind the rear seat backrests.
- ▷ Cover sharp edges and corners.

- ▷ For very heavy cargo when the rear seat is not occupied, secure each safety belt in the respective opposite buckle.
- ▷ Do not stack higher than the top edge of the backrests.
- ▷ Use the partition net, refer to page 99. Ensure that no objects can penetrate through the net.

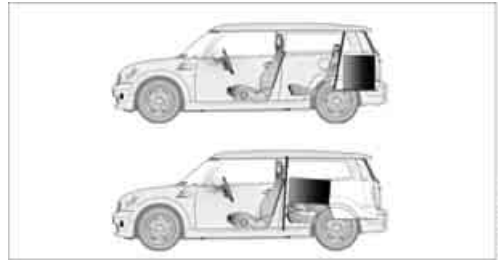

Securing cargo



By way of example, the illustration shows the cargo compartment in the MINI.

- ▷ Secure smaller and lighter items using retaining or draw straps*.
- ▷ Heavy-duty cargo straps* for securing larger and heavier objects are available at your MINI dealer. Four lashing eyes are provided for attaching the cargo straps. Two of them are located on the forward wall of the cargo bay. Comply with the information enclosed with the load-securing devices.

! Always position and secure the cargo as described above, so that it cannot endanger the car's occupants, for example if sudden braking or swerves are necessary. Do not exceed the approved gross weight and axle loads, page 194; otherwise, the vehicle's

operating safety is no longer assured and the vehicle will not be in compliance with the certification regulations.

Heavy or hard objects should not be carried loose inside the car, since they could be thrown around, for example as a result of heavy braking, sudden swerves, etc., and endanger the occupants. Do not secure cargo using the fastening points for the tether strap, page 44; they may become damaged. ◀

ROOF-MOUNTED LUGGAGE RACK*

A special rack system is available as an option for your MINI. Your MINI dealer will be glad to advise you. Comply with the installation instructions supplied with the rack system.

Mounting points

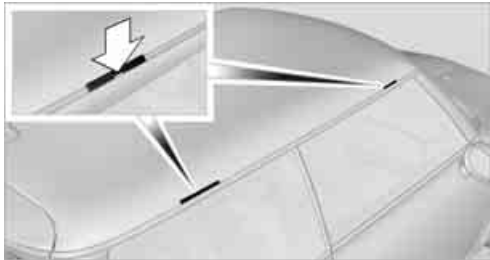

By way of example, the illustration shows the roof of the MINI.

Remove the cover panel.

Loading roof-mounted luggage rack

Because roof racks raise the vehicle's center of gravity when loaded, they have a major effect on vehicle handling and steering response. You should therefore always remember not to exceed the approved roof load capacity, the approved gross vehicle weight or the axle loads when loading the rack.

You can find the applicable data under Weights on page 194.

The roof load must be distributed uniformly and should not be too large in area. Heavy items should always be placed at the bottom.

When loading, make sure that there is sufficient space for the movement of the glass sunroof.

Fasten roof-mounted cargo correctly and securely to prevent it from shifting or falling off during the trip.

Drive smoothly. Avoid sudden acceleration and braking maneuvers, and take corners gently.

SAVING FUEL

Fuel consumption depends on a number of different factors. The implementation of certain measures, your driving style and regular maintenance can have an influence on fuel consumption and on the environmental impact.

Remove unnecessary cargo

Additional weight increases fuel consumption.

Remove attached parts no longer in use

Remove auxiliary mirrors, roof- or rear-mounted luggage racks whenever you are not using them.

Attached parts on the vehicle affect its aerodynamics and increase fuel consumption.

Check tire inflation pressure regularly

Check and, if necessary, correct tire inflation pressure at least twice a month and before starting on a long trip.

Low inflation pressure increases rolling resistance and thus leads to greater fuel consumption and tire wear.

Drive off immediately

Do not wait for the engine to warm up while the vehicle remains stationary. Start driving right away, but at moderate engine speeds. This is the fastest way for the cold engine to reach its operating temperature.

Think ahead while driving

Avoid unnecessary acceleration and braking by maintaining a suitable distance to the vehicle driving ahead.

Driving smoothly and anticipating impending traffic situations reduces fuel consumption.

Avoid high engine speeds

Use first gear only for driving off. In second and higher gears, accelerate smoothly to a suitable engine and road speed. In doing so, avoid high engine speeds and shift up early.

When you reach your desired traveling speed, shift to the highest suitable gear and drive at constant speed.

As a rule: driving at low engine speeds lowers fuel consumption and reduces wear.

Coasting

When approaching a red traffic light, take your foot off the accelerator and let the vehicle coast to a halt in the highest suitable gear.

On a downhill gradient, take your foot off the accelerator and let the vehicle coast in a suitable gear.

Fuel supply is shut off automatically when the vehicle is coasting.

Switch off the engine during lengthy stops

Switch off the engine when stopping for lengthy periods, e.g. at traffic lights, railroad crossings or in traffic jams.

Have the vehicle serviced

Have your vehicle serviced regularly to achieve good economy and a long vehicle life. The manufacturer of your MINI recommends having the vehicle serviced by a MINI dealer. Also note the MINI Maintenance System, page [170](#).





AT A GLANCE

CONTROLS

DRIVING TIPS

NAVIGATION

ENTERTAINMENT

MOBILITY

REFERENCE

STARTING THE NAVIGATION SYSTEM*

Your navigation system can use satellites to ascertain the precise position of your vehicle and guide you reliably to any destination you enter.

NAVIGATION DVD

The navigation system requires a special navigation DVD. You can obtain the latest version from your MINI dealer.

Inserting navigation DVD



Use the lower drive for the navigation DVD.

1. Press the button, arrow, and remove the cover.
2. Insert the navigation DVD with the labeled side up.
3. To replace the cover, first insert it on the left and then press forward on the right until it snaps in.



4. Wait for several seconds to allow the contents of the DVD to be read in.

Removing navigation DVD

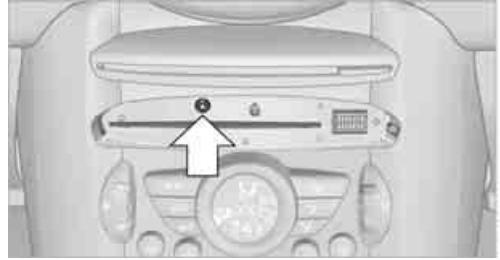

1. Press the button.
The DVD emerges slightly from the drive.
2. Remove the DVD.

If the DVD is not ejected, the drive may be blocked. In this case, a message will appear on the Control Display.

Displaying arrow view in map display

When destination guidance is active, the arrow view can be displayed additionally on the right side of the map display.

1. Press the  button.
This opens the start menu.
2. Move the MINI joystick to highlight "Setup" and press the MINI joystick.
3. Select "Settings".
4. Turn the MINI joystick until "Language / Units" is selected and press the MINI joystick.
5. If necessary, move the highlight marker to the uppermost field. Turn the MINI joystick until "Languages" is selected and press the MINI joystick.
6. Select "Display arrow view" and press the MINI joystick.

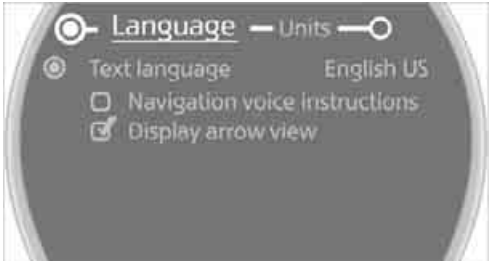

The arrow display is shown.

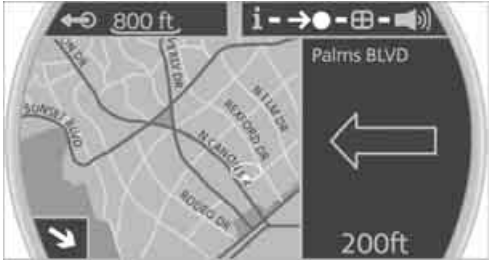

DESTINATION ENTRY

In entering your destination you can select from the following options:

- ▷ Entering a destination manually, see below
- ▷ Entering a destination by voice commands*, page 111
- ▷ Selecting destination using information, page 114
- ▷ Selecting destination from a list, Destination list, page 115
- ▷ Selecting destination from address book, page 115
- ▷ Storing home address, page 117

After selecting your destination you can proceed to start the destination guidance, page 120.

 Enter data only when the vehicle is stationary, and always give priority to the applicable traffic regulations in the event of any contradiction between traffic and road conditions and the instructions issued by the navigation system. If you do not observe this precaution, you may be in violation of the law, and can endanger vehicle occupants and other road users. ◀

OPENING NAVIGATION

Onboard monitor, for operating principle refer to page 16.

1. Press the  button.
This opens the start menu.
2. Move the MINI joystick to highlight "Navigation" and press the MINI joystick.



3. Select "Navigation".



The following information is displayed on the onboard monitor:

- ▷ During destination guidance: the arrow or map view
- ▷ When destination guidance is switch off: the destination list

ENTERING A DESTINATION MANUALLY

The system's word-matching principle makes it easier to enter the names of streets or towns, page 119. This allows you to enter different spellings and completes your entry automatically so that stored names can be called up quickly.

1. If necessary, move the highlight marker to the uppermost field.
2. Select "Navigation".
"New destination" is highlighted.
3. Press the MINI joystick.

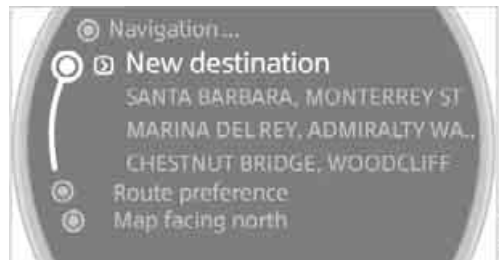

4. Select "Enter address".

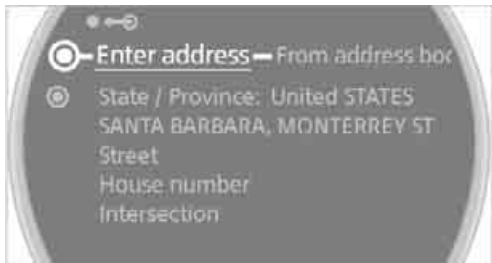

The system also supports you with the following features:

- ▶ If you do not enter a street, the system will guide you to the downtown area of a town or city.
- ▶ You can skip the entry of country and locality if the current entries should be retained for your new destination.

Selecting country

1. Select "State / Province" or displayed country.

The list of available countries appears on the display.

2. Select the country of destination.



At least the town/city of the destination or its zip code must be entered in order to start the destination guidance.

Entering destination by town/city name

1. Select "Town / City" or displayed city.

2. Select the first letter.

A list of all towns/cities starting with this letter appears on the Control Display.

3. Delete letters if necessary:



- ▶ To delete individual numbers or letters: Move the MINI joystick to the right to highlight **X** and press the MINI joystick.
- ▶ To delete all numbers or letters: Move the MINI joystick to the right to highlight **X** and press the MINI joystick for an extended period.

4. If necessary, enter more letters.

The list gradually grows smaller each time you enter a new letter.

- ▶ To enter spaces, if necessary: Select the **_** symbol.

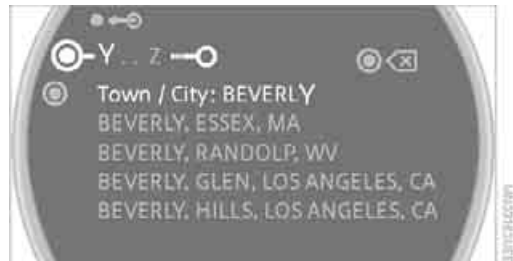

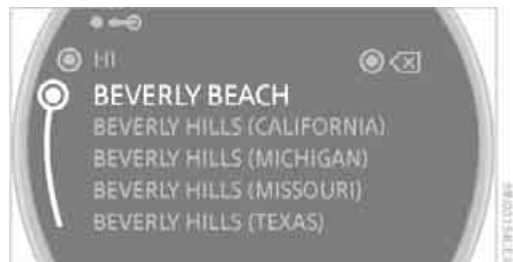

5. If necessary, change to the list of towns and cities and select a name.



Entering destination by zip code

1. Select "City / Zip code".
2. Enter the zip code:
Select the digits individually.
 - ▶ To enter spaces, if necessary:
Select the _ symbol.



- ▶ To delete individual numbers or letters:
Move the MINI joystick to the right to highlight  and press the MINI joystick.
 - ▶ To delete all numbers or letters:
Move the MINI joystick to the right to highlight  and press the MINI joystick for an extended period.
3. Select the zip code.
The corresponding destination is displayed.
 4. Move the highlight marker to the third field from the top. Select the town/city.

Entering street, house number and intersection

After the street you can also enter the intersection or the house number.

Entering street and intersection

1. Select "Street" or displayed street.
2. Enter the street.
The street is entered in the same manner as the town or city.



The intersection is entered in the same way as the street.

Entering a street without entering a town/city

You can also enter a street without specifying a town/city. In this case, all streets in the designated country are offered. The corresponding town/city is displayed after the street name.

1. Turn the MINI joystick until "State / Province" or the displayed country is selected.
The list of available countries appears on the display.
2. Select the country of destination.
3. Turn the MINI joystick until the "Street" is selected.
4. Select the first letter.
A list of all streets starting with this letter and of the associated towns/cities appears on the Control Display.

- If necessary, enter more letters.
The list gradually grows smaller each time you enter a new letter.



- Change to the list of street names and select the street name in the corresponding town/city.

Entering a house number

You can enter all house numbers that are stored for the street on the navigation DVD.

- Select "House number".
- To enter the house number:
Select the digits individually.
- Move the highlight marker to the third field from the top. Select the house number.
You can only enter house numbers that are stored for the street on the navigation DVD.

Starting destination guidance with manual destination entry

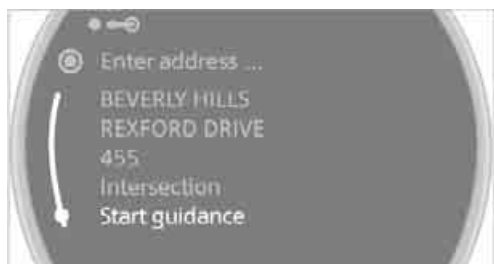

- ▷ Select "Start guidance".
Destination guidance starts immediately.
- ▷ If you do not want to start destination guidance right away:
Select "Add to destination list".
The destination is stored in the destination list, page 115.

ENTERING A DESTINATION BY VOICE COMMANDS*

You can enter a desired destination via the voice activation system. During the destination input, you can switch between voice entry and entry via the onboard monitor at any time. To do so, reactivate the voice activation system if necessary.

 You can have the possible commands read aloud via ›Options‹. ◀

- Press the  button on the steering wheel.
- ›Enter address‹



Selecting country

- Wait for the system to ask for the country of destination.
-  Say the name of the destination country.

Say the name of the destination country in the language of the voice activation system.

Entering destination

The destination can be spelled or entered as an entire word.

Spelling the destination

To enter a destination, spell it in the way it is commonly spelled in the destination country. Pronounce the letters smoothly and at normal volume, avoiding excessive emphases and pauses.

-  To spell the name of a town/city:
Say at least the first three letters of the town/city. The more letters you say, the more accurately the system will recognize the town/city.

The system can suggest up to 20 destinations that meet your entries.
Up to 6 entries at a time appear on the Control Display.



The system suggests a location.

2. Select location:
 - ▶ To select highlighted town/city: ›Yes‹
 - ▶ To select other town/city: ›No‹
 - ▶ To select an entry, e.g. ›Entry 3‹
 - ▶ To show other entries in the list: ›Next page‹
 - ▶ To respell the town/city: ›Repeat‹

The town/city can also be selected from the list via the onboard monitor:
Turn the MINI joystick until the town/city is selected.

Entering the destination as an entire word

Towns/cities and streets located in the region where the language of the voice activation system is spoken can be entered as an entire word.

Example: to enter a U.S. destination as an entire word, the system language must be English.

A prerequisite is the use of a suitable navigation DVD.

Pronounce the words smoothly and at normal volume, avoiding excessive emphases and pauses.

1. Wait for the system to ask for the town/city of destination.
2. Say the name of the destination town/city.

The system can suggest up to 6 destinations that meet your entry.



The system suggests a location.

3. Select location:
 - ▶ To select highlighted town/city: ›Yes‹
 - ▶ To select other town/city: ›No‹
 - ▶ To select an entry, e.g. ›Entry 3‹
 - ▶ To reenter the town/city: ›Repeat‹
 - ▶ To enter the town/city by spelling: ›Spell‹

The town/city can also be selected from the list via the onboard monitor:
Turn the MINI joystick until the town/city is selected.

Identical-sounding towns/cities that cannot be distinguished by the system are compiled in a separate list and shown as a destination followed by three dots.

If applicable, select this entry with ›Yes‹. Then select the desired town/city from that list. ◀

Entering street and house number

The street is entered in the same way as the destination town/city.

To enter the house number:

1. ›House number‹
2. Say the house number.

House numbers of up to 4 digits can be entered.
Say the house numbers as individual digits.



Starting destination guidance

 ›Start guidance◀

Destination guidance starts immediately.

Storing destinations

Destinations are added to the destination list or can be stored in the address book.

 ›Add to destination◀ or
 ›Add to address book◀

MAP-GUIDED DESTINATION SELECTION

If you only know the location of the town or street of destination, you can enter the destination using a map. Select the destination on the map using cross-hairs and then transfer it for destination guidance.

1. Select "Navigation".
"New destination" is highlighted.
2. Press the MINI joystick.

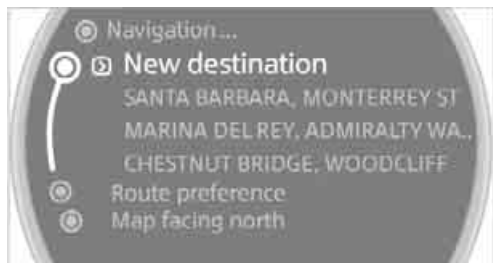

3. Select "Input map".

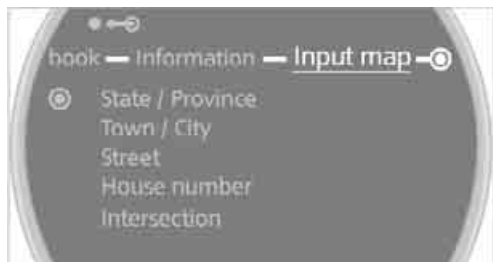

A section of a map is displayed on the Control Display:

- ▶ During destination guidance, around the current destination

- ▶ With the destination guidance deactivated, around the last destination entered



4. Select the destination using the cross-hairs.
 - ▶ To change the scale: turn the MINI joystick.
 - ▶ To move the map: move the MINI joystick in the corresponding direction.
The MINI joystick can be moved to the left, right, forward and backward.
5. Transfer the destination for destination guidance or store it: press the MINI joystick. The selected destination and other menu items are displayed.
6. Select the desired menu item:
 - ▶ "Start route guidance" starts the destination guidance.
 - ▶ "Show current position" places the current position in the center of the map.
 - ▶ "Show destination position" places the current destination in the center of the map.
 - ▶ "Return to map" switches back to the "Input map".
 - ▶  Exit the menu.

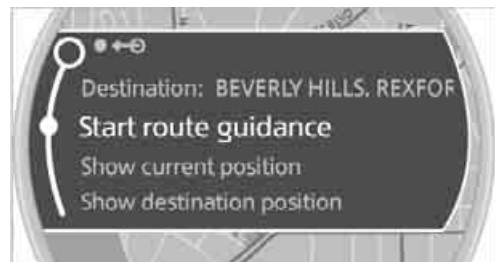

The map for destination entry can also be called up in the map display:
Select the  symbol.

SELECTING DESTINATION USING INFORMATION

To have selected destinations, e.g. hotels, sights or hospitals, displayed, called up and transferred for destination guidance.

1. Select "Navigation".
"New destination" is highlighted.
2. Press the MINI joystick.
3. Select "Information".



4. Select location:
 - ▷ "On destination"
 - ▷ "On location"
 - ▷ "On a new destination"

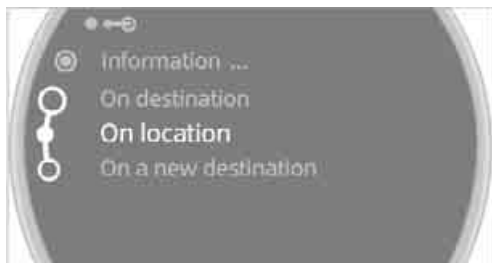

5. Press the MINI joystick.
6. Select the one you want, e.g. "Hotels and restaurants" and press the MINI joystick.
7. If necessary, enter any search criteria, e.g. the maximum distance from your current location.

8. Select "<Start search>" and press the MINI joystick.
Destinations are shown on the Control Display.
9. Select a destination and press the MINI joystick.



 The scope of information and symbols depends on the particular navigation DVD. ◀

10. Select a menu item:
 - ▷ To transfer the address to the destination list and start destination guidance:
 - ▶▶ Select the symbol and press the MINI joystick.
 - ▷ To establish a telephone connection:
 - ☞ Select the symbol and press the MINI joystick.
 - ▷ To display additional destinations:
 - ◀▶ Select the symbol and press the MINI joystick.
 - ▷ To start a new search:
 - 🔍 Select the symbol and press the MINI joystick.

Exiting the menu

 Select the arrow.

Symbols in map view

If you select the hotel category, for example, hotels appear on the map as symbols.

To hide the symbols in map view:

1.  Select the symbol and press the MINI joystick.
2. Select "Hide map icons" and press the MINI joystick.

The symbols are hidden.

To show the symbols:

Select "Show map icons" and press the MINI joystick.

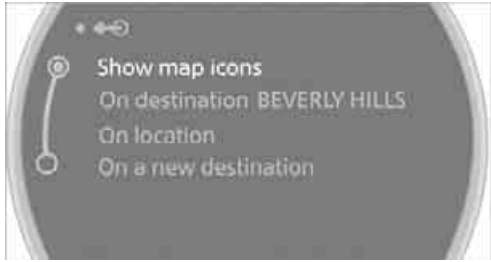

To exit from the menu:

← Select the arrow.

DESTINATION LIST

The last 20 destinations entered into the system are shown in the destination list. These destinations can be called up and transferred for destination guidance.

Planning a longer route: all destinations that you wish to drive to can be stored in advance in the destination list, refer to Entering a destination manually on page 108.

Select "Navigation".

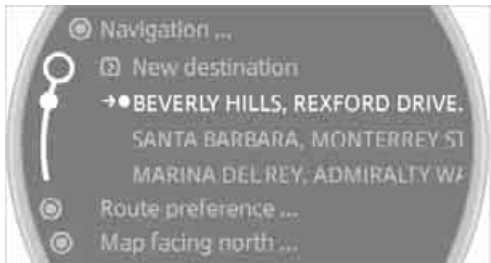

The destination last entered is listed first in the destination list.

→● This symbol indicates the current destination.

To show other destinations in the destination list:
turn the MINI joystick.

Transferring destination for destination guidance

1. Select the desired destination from the destination list.
2. Select "Start guidance".

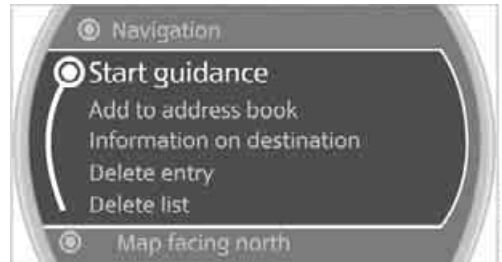

Editing destination list

1. Select the desired destination from the destination list.
2. The selected destination can be edited:
 - ▷ To store the entry:
Select "Add to address book".
 - ▷ To display information on the destination:
Select "Information on destination".
 - ▷ To delete the entry:
Select "Delete entry".
 - ▷ To delete all entries:
Select "Delete list". The destination guidance is switched off.
 - ▷ To change an entry:
Select "Edit", for operation refer to Entering destination by town/city name, page 109.

ADDRESS BOOK

Opening address book

Onboard monitor, for operating principle refer to page 16.



Select "Address book".

Storing destinations in address book

You can store approx. 100 destinations in the address book.

1. Select "Address book".
2. Select "New address".

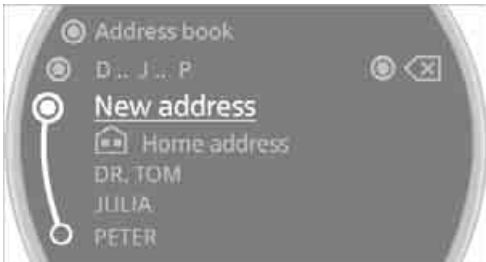

3. Select "Enter address".
4. Enter the name and address, refer to Entering a destination manually, page 108.
5. Select "Store in address book".

The entry is stored in the address book.

You can also store a destination from the destination list in the address book, page 115.

Storing current position*

The current position can be transferred to the address book.

1. Select "Address book".
2. Move the highlight marker to the third field from the top. Turn the MINI joystick until the "New address" is selected.



3. Select "Use current location as address".
The name given can be changed. For operation, refer to Entering a destination manually, page 108.
4. Select "Store in address book".

You can also enter your current position into the address book if you have left the area covered by the navigation DVD. In this case, you must enter a name.

Selecting destinations from address book

1. Select "Address book".
The stored entries appear on the Control Display.



2. Select an entry.

Starting destination guidance

Select "Start guidance".



Changing destinations from address book

1. Select "Address book".
2. Select an entry.
3. Select "Edit address".



4. Change entry.
For operation, refer to Entering a destination manually, page 108.
5. Select "Store in address book".

Deleting individual destinations from address book

1. Select "Address book".
2. Select an entry.
3. Select "Delete address".



4. Select "Yes".

Deleting all destinations from address book

1. Press the  button.
This opens the start menu.
2. Move the MINI joystick to highlight "Setup" and press the MINI joystick.
3. Select "Settings".
4. Select "Vehicle / Tires".
5. Select "Delete data".

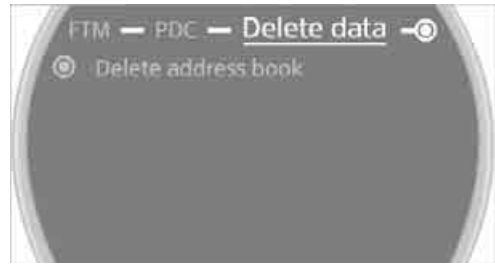

6. Select "Delete address book".
7. Select "Yes".

Home address

You can store your current position or the current destination as the home address in the address book. This entry occupies the second position in the address book.

Storing home address

1. Select "Address book".
2. Select "Home address".

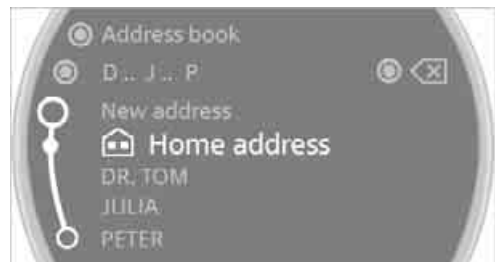

3. Select "Use current location as address" or during destination guidance, select "Save current destination".

Using home address as destination

1. Select "Home address".
2. Select "Start guidance".

Changing the home address

1. Select "Home address".
2. Select "Edit address".
For operation, refer to Entering a destination manually, page 108.

ROUTE SELECTION

You can influence the calculated route by choosing certain route criteria. You can change the route criteria as often as you like during destination entry or during destination guidance.

The route is planned according to fixed rules. The type of road is taken into account, e.g. whether it is a highway or a winding road. The road types are stored on the navigation DVD. As a result, the routes recommended by the navigation system may not always be the same ones that you would choose based on personal experience.

Changing route criteria

1. Select "Navigation".
2. Select "Route preference".

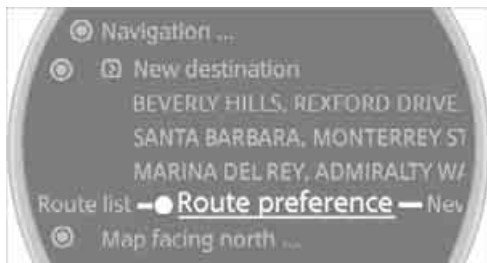

The various criteria are listed on the Control Display.

3. Select a route criterion for the route:
 - ▷ "With highways"
Highways and main traffic thoroughfares are selected.
 - ▷ "Avoid highways"
Highways are avoided if possible.
 - ▷ "Fast route"
short time through combination of the shortest possible distance and routes that can be driven quickly
 - ▷ "Short route"
short distance without taking time into account
- ▶ The route criterion is selected.



4. Select any additional criteria for the route, if necessary:
 - ▷ "Dynamic route"
Automatic changing of the route in the event of traffic obstructions. Depending on road type and the kind and extent of the traffic obstruction, the guided route may lead through the traffic obstruction.
 - ▷ "Avoid tollroads"
Tollroads are avoided if possible.
 - ▷ "Avoid ferries"
Ferries are avoided if possible.
- ☑ The route criterion is selected.

The route criteria can also be changed in the arrow or map view:

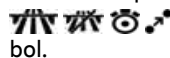
 Select the corresponding symbol.

 If the route criteria "Avoid highways", "Avoid tollroads" or "Avoid ferries" are selected, then this can add significantly to the calculation time of the route. ◀

Exiting the menu

↩ Select the arrow.

WORD-MATCHING PRINCIPLE

The system's word-matching principle makes it easier to enter the names of towns or streets.

The system runs ongoing checks, comparing your destination entries with the data stored on the navigation DVD as the basis for instant response. The benefits for you include:

- ▷ Names of towns entered may differ from the official versions if you are using a spelling that is customary in another country.

Example:

Instead of "München", you can also enter the English spelling "Munich" or the Italian spelling "Monaco".

- ▷ When you are entering the names of towns and streets the system will complete them automatically as soon as enough letters are available to ensure unambiguous identification.
- ▷ The system offers only those letters for selection of name entries that are stored on the navigation DVD. Thus, entry of erroneous or unregistered names is impossible.

DESTINATION GUIDANCE

STARTING DESTINATION GUIDANCE

Onboard monitor, for operating principle refer to page 16.

1. If necessary, move the highlight marker to the uppermost field. Select "Navigation".
2. Select the destination from the destination list or enter a new destination, page 108.



3. Select "Start guidance".

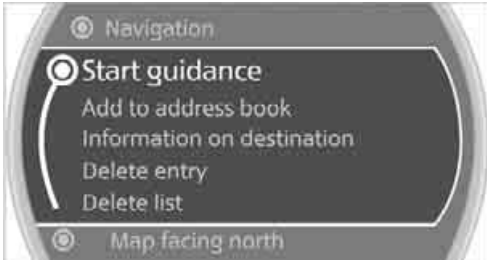

After the route has been calculated, destination guidance is indicated by arrows or a map on the Control Display.

The destination guidance can also be started in the arrow or map view:
Select the  symbol.

At any time during destination guidance, you can operate other equipment items via the onboard monitor. You will be notified in time of any necessary change of direction by means of spoken instructions and the display of the direction arrows.

TERMINATING/CONTINUING DESTINATION GUIDANCE

In the arrow or map view

Select the  symbol.



In the destination list

 This symbol indicates the current destination.

1. Select the current destination.



2. Select "Stop guidance".

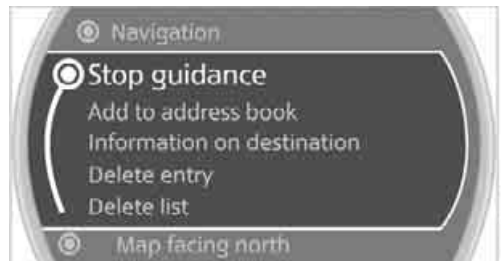

If you did not reach the destination before the end of the last journey, the following question will appear in the display at the start of the next journey:

"Continue guidance to destination?".

The destination guidance starts automatically after a short time.

Starting destination guidance immediately

Select "Yes".

ROUTE DISPLAY

You have the option of displaying various views of the route during destination guidance.

Displaying arrow view

1. Select "Navigation".
2. Select "Arrow display".



The arrow display is shown.



- 1 Switching voice instructions on/off
- 2 Manually calling up traffic information*
Symbol with red border: traffic information is available for the planned route
- 3 Selecting route criteria

- 4 Starting/stopping destination guidance
- 5 Arrow to destination as the crow flies
- 6 Distance to the next change of direction
- 7 Direction of travel
 - ▷ Outline of an arrow:
Destination guidance on the calculated route
 - ▷ Solid arrow:
Arrow points as the crow flies to the calculated route whenever the vehicle is not in an area recorded on the navigation DVD, e.g. in a parking garage.
- 8 Current location

The status line displays the estimated time of arrival and the distance to the destination.

The arrows change appearance before a change of direction.



- 1 Street name for change of direction
- 2 Distance to change of direction
- 3 Change of direction

Exiting the menu

Select the arrow.

Displaying map view

You can have your current position displayed on a map. After destination guidance is started, the planned route is shown on the map.

1. Select "Navigation".
2. Move the highlight marker to the fourth field from the top. Select the desired map view:
 - ▷ "Map facing north"
 - ▷ "Map direction of travel"
 - ▷ "Perspective"



Display



- 1 **i** Displaying the menu in which the information last selected can be shown/hidden, refer to [Selecting destination using information](#), page 114
- 2 **→●** Starting/stopping destination guidance
- 3 **⊕** Map-guided destination selection
- 4 **🔊** Switching voice instructions on/off
- 5 Arrow to destination as the crow flies



- 1 Changing map view
 - ▷ **AN** "Map facing north"
 - ▷ **🏠** "Map direction of travel"
 - ▷ **🏠** "Perspective"
- 2 **⚠️** Manually calling up traffic information*
Symbol with red border: traffic information is available for the planned route
- 3 Changing route criteria:
 - ▷ **🛣️** Prefer highways
 - ▷ **🚫** Avoid highways
 - ▷ **🏎️** Fast route
 - ▷ **📍** Short route
- 4 Arrow to destination as the crow flies

Exit the menu:

↩️ Select the arrow.

The status line displays the estimated time of arrival and the distance to the destination.

At scales of less than 250 miles/500 km, you have the option of deciding whether to orient the map to north, toward your current direction of travel, or show the map in perspective. At scales of 250 miles/500 km or greater, the map always points toward north.

Changing map view



Select the corresponding symbol.

The next map view is displayed.

Changing the scale

1. In the map view, change to the top left field.
2. Turn the MINI joystick to change the scale.

Displaying towns/cities and streets along the route

You can have the roads and towns along the route displayed during destination guidance.

The distances remaining to be traveled within each section of the route are also shown.

1. Select "Navigation".
2. Move the highlight marker to the third field from the top. Select "Route list".

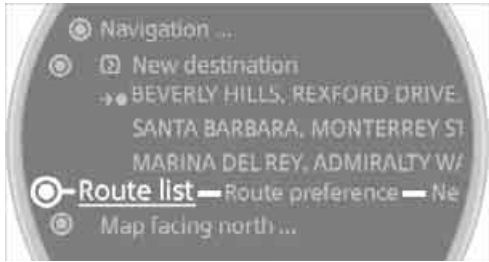

Exiting the menu

↩ Select the arrow.

DESTINATION GUIDANCE THROUGH VOICE INSTRUCTIONS

Switching voice instructions on/off

The voice instructions can be switched on/off in the arrow or map view:

1. Change to the top right field.
2. Select the  symbol.



Switching voice instructions on/off at any time

1. Press the  button. This opens the start menu.
2. Move the MINI joystick to highlight "Setup" and press the MINI joystick.
3. Select "Settings".



4. Select "Language / Units".
5. If necessary, move the highlight marker to the uppermost field. Select "Language".



6. Select "Navigation voice instructions".
 The voice instructions are switched on.

Adjusting volume for voice instructions

The volume can be adjusted only while a voice instruction is being issued.

1. Repeat the last voice instruction if necessary.
2. Turn the button during the voice instruction to select the desired volume.



This volume is independent of the volume of the audio sources.

The setting is stored for the remote control currently in use.

CHANGING A ROUTE

Taking detours

During destination guidance, you can revise the navigation system's route recommendations to avoid particular stretches of road. Enter the number of miles/kilometers that you want to travel before returning to the original route.

1. Select "Navigation".
2. Move the highlight marker to the third field from the top. Select "New route".

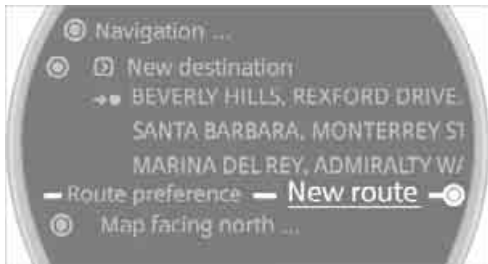

A detour can be made around a specified section of the total route length.

3. Turn the MINI joystick to enter the desired number and press the MINI joystick.

The route is recalculated.

Exiting the menu without changing the route

← Select the arrow.

TRAFFIC INFORMATION*

In many metropolitan areas you can receive traffic information broadcast by radio stations. The traffic conditions are monitored by traffic control centers and the traffic information is updated periodically.

During destination guidance, the traffic information relevant to the route you are planning to take is automatically shown and taken into account in route planning. Irrespective of whether destination guidance is active, you can have the traffic information displayed in the map display or as an event list.

Switching reception of traffic information on/off

Onboard monitor, for operating principle refer to page 16.

1. Press the button. This opens the start menu.
2. Move the MINI joystick to highlight "Setup" and press the MINI joystick.
3. Select "Settings".



4. Select "Traffic Info settings".



5. Select "Traffic Info".

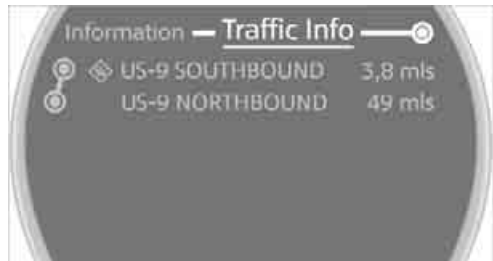

The traffic information can be received and displayed.

"AUTO": automatic selection of the strongest-signal Traffic Info station.

Depending on the station, either the station name, frequency, local number or other information is displayed. ◀

Calling up traffic information manually

During destination guidance

During destination guidance, traffic information can be called up manually in the arrow or map display.

If the symbol is shown with a red border, there is traffic information regarding the planned route.

1. Change to the top right field.
2. Select the symbol.



During destination guidance, traffic information items along the planned route are indicated by yellow diamonds.

Traffic information on the planned route is shown first, sorted by distance from the vehicle's current position.

With destination guidance switched off

1. Press the button. This opens the start menu.
2. Move the MINI joystick to highlight "Navigation" and press the MINI joystick.
3. Select "Traffic Info".

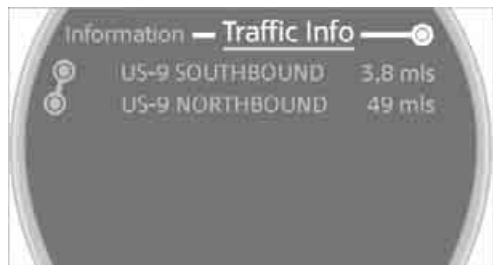

Traffic information on the planned route is shown first, sorted by distance from the vehicle's current position.

Displaying traffic information in map view

In map view, the traffic information icons are shown up to a scale of 100 miles/200 km.

The highlighting of the stretch corresponding to the traffic report and the icons for the type of event as described below are displayed and hidden. This depends on the selected scale.

Displaying detailed traffic information









Select a traffic information item from the list.



Exiting the menu

← Select the arrow.

Traffic information icons

-  Traffic event displayed with map scales larger than 5 miles/10 km; arrow points in the relevant direction of travel.
-  There are several traffic events. Switch to a smaller map scale to show more detail.
-  Traffic light failure
-  Road construction
-  General traffic obstruction
Transport of hazardous load
Vehicle on wrong roadway
-  Danger
-  Low clearance
-  No parking
-  Fog

-  Heavy rain
-  Slippery road
-  Cross winds
-  Smog
-  Road closed
-  Slow traffic
-  Traffic backup
-  Stopped traffic
-  Icy roads
-  Uneven surface
-  Accident
-  Lane closure
-  Delay
-  Police checkpoint



- Slow traffic or other traffic event
- Stop-and-go traffic
- Stopped traffic
- Traffic event in both directions of travel

Traffic information during destination guidance

Depending on whether "Dynamic route" is selected, refer to page 118, the system behaves in different ways.

Displaying traffic obstructions

If a traffic obstruction is reported in the navigation system and "Dynamic route" is not selected, starting from a distance of approx. 25 miles/40 km, you will begin receiving certain information, e.g. the length of the traffic jam will be displayed.

The last possible detour exit is indicated just before you reach it.



This information is displayed even if you have called up another application on the Control Display.

Dynamic route planning

If "Dynamic route" is selected, then the route is automatically changed in the event of traffic obstructions. The system will not point out traffic obstructions on the original route.

Depending on road type and the kind and extent of the traffic obstruction, the newly calculated route may still lead through the traffic obstruction.

DISPLAYING CURRENT POSITION

You can have your current position displayed even when the destination guidance is switched off.

1. Select "Navigation".
2. Move the highlight marker to the fourth field from the top. Select "Current position".

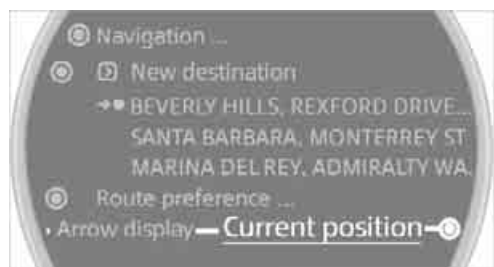

The current position of your MINI is displayed.

If the navigation system is unable to identify a town or city, your current map coordinates will appear.

Exiting the menu

Select the arrow.

You can also have your current position displayed on a map, page 121.

WHAT TO DO IF ...

What to do if ...

- ▷ a navigation DVD is inserted, but an instruction to insert the DVD appears on the Control Display?
The navigation DVD may not be the correct DVD for the navigation system. This information is indicated on the DVD label.
- ▷ you request the current position of your vehicle, but do not receive a precise display?
The system is unable to receive enough GPS signals at your current position due to obstructions, your current position is not yet available on your navigation DVD, or the system is in the process of calculating your current position. As a rule, reception is guaranteed when you are in the open.
- ▷ the destination guidance does not accept a destination?
The data of the destination is not stored on the navigation DVD that is loaded. Choose a destination as close as possible to the original one.
- ▷ the destination guidance does not accept an address without the street name?
On the navigation DVD, no downtown area can be determined for the city or town entered. Enter any street, or a destination such as the railway station in the selected town, and then start the destination guidance.
- ▷ you want to enter a destination for the destination guidance, but it is not possible to select the letters for your desired entry?
The data of the destination is not stored on the navigation DVD that is loaded. In this case, the system will not offer you any letters to choose from. Choose a destination as close as possible to the original one.
- ▷ the system stops furnishing directions on which way to turn as you approach intersections?
You are driving in an area that has not yet been completely recorded on the navigation DVD. Instead of an arrow indicating a turn, you will see an arrow which indicates the general direction of your planned route. Or you have left the recommended route and the system requires a few seconds to calculate a new recommended route.
- ▷ the navigation system does not react to entries?
If the battery was disconnected, it takes about 10 minutes before the system is once again operational.



AT A GLANCE

CONTROLS

DRIVING TIPS

NAVIGATION

ENTERTAINMENT

MOBILITY

REFERENCE

ON/OFF AND SETTINGS

The following audio sources have shared controls and settings options:

- ▷ Radio
- ▷ CD player
- ▷ CD changer*

CONTROLS

The audio sources can be operated using:

- ▷ Buttons near the CD player
- ▷ Onboard monitor
- ▷ Buttons on steering wheel, page 11

Buttons near the CD player

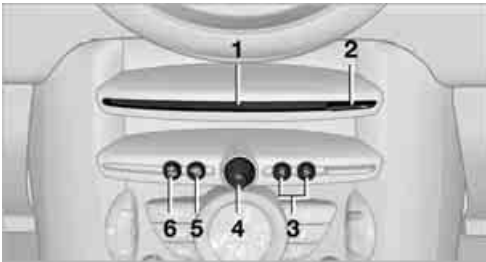

- 1 Drive for audio CDs
- 2 Eject CD
- 3 Station scan/track search
 - ▷ Change radio station.
 - ▷ Select track for CD player and CD changer.
- 4 Sound output for entertainment on/off, volume
 - ▷ Press: switch on/off.
When you switch on the unit, the radio station or track set most recently is played.
 - ▷ Turn: adjust volume.
- 5 Change audio source
- 6 Change FM/AM frequency

Operation via onboard monitor

Onboard monitor, for operating principle refer to page 16.

1. Press the button.
This opens the start menu.
2. Move the MINI joystick to highlight "Entertainment" and press the MINI joystick.



You have the following choices:

- ▷ "FM" and "AM": radio reception
- ▷ "HD radio": High Definition Radio*
- ▷ "SAT": satellite radio*
- ▷ "CD": CD player or CD changer
- ▷ "AUX": AUX-IN port, USB audio interface*

The selected audio source is stored for the remote control currently in use, refer to Personal Profile, page 26.

SWITCHING ON/OFF

Entertainment audio output



Press the button.

🔊 This symbol at the lower edge of the Control Display indicates that the audio output has been switched off.

ADJUSTING VOLUME



Turn the knob to the desired volume.
You can also adjust the volume with buttons on the steering wheel, page 11.
The setting is stored for the remote control currently in use, refer to Personal Profile, page 26.

TONE CONTROL

You can alter various tone settings, e.g. treble and bass or the speed-dependent volume increase.
The tone settings are applied to all audio sources.

The settings are stored for the remote control currently in use, refer to Personal Profile, page 26.

Changing tone settings

1. Press the  button.
This opens the start menu.
2. Move the MINI joystick to highlight "Setup" and press the MINI joystick.
3. Select "Settings".

4. Select "Audio".



Treble and bass

1. Select "Treble / Bass".

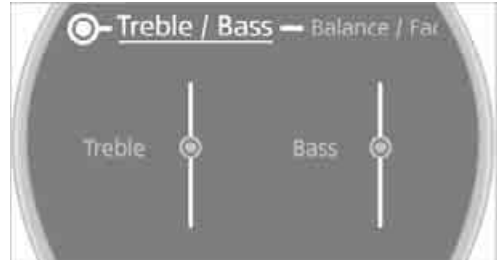

2. Move the MINI joystick to highlight to the left or right to select "Treble" or "Bass".
3. Turn the MINI joystick until the desired setting is reached.

Balance and fader

You can adjust the balance/fader in the same way as "Treble / Bass".

- ▷ "Balance": balance right/left
- ▷ "Fader": fader front/rear

Speed-dependent volume control

The speed-dependent volume control automatically increases the volume with increasing driving speed. You can set various stages for the increase in volume.

1. Select "Speed volume".

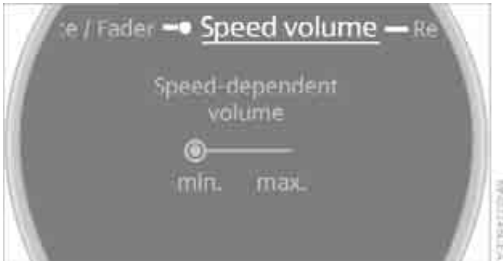

2. Turn the MINI joystick:
The adjustment is applied; the field can be changed.

Resetting tone settings

You can reset all tone settings to the default setting.

1. Press the  button.
This opens the start menu.
2. Move the MINI joystick to highlight "Setup" and press the MINI joystick.
3. Select "Settings".
4. Select "Audio".
5. Select "Reset".

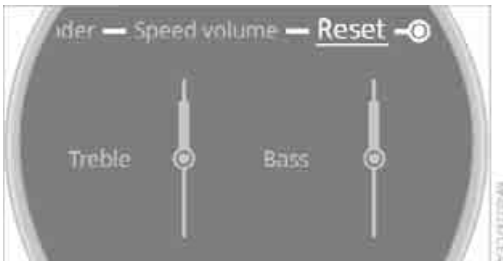

6. Select "Yes".

RADIO

Your radio provides reception of the FM and AM wavebands.

LISTENING TO THE RADIO



Press the button if the sound output is switched off.

Onboard monitor, for operating principle refer to page 16.

1. Press the button. This opens the start menu.
2. Move the MINI joystick to highlight "Entertainment" and press the MINI joystick.
3. If necessary, move the highlight marker to the uppermost field. Select "FM" or "AM".



Stations are displayed on the Control Display according to various selection criteria, e.g. "All stations".

If no stations are displayed in the AM waveband under "Autostore" or if the displayed stations are no longer in reception range, then update the strongest radio stations, page 136.

Changing stations



Turn the MINI joystick.

Buttons on the CD player

Press the button for the corresponding direction.

The system switches to the next displayed station.

You can also change the station using buttons on the steering wheel, page 11.

Changing selection criteria

In addition to the stations currently displayed, you can have stations with another selection criterion displayed.

You can choose from the following selection criteria:

- ▷ "All stations"*:
Stations that can currently be received in the "FM" waveband.
- ▷ "Autostore":
The strongest stations in the "AM" waveband.
For High Definition Radio: the strongest stations in the "FM" waveband.
- ▷ "Presets":
Stations that you have memorized previously, page 137.
- ▷ "Manual":
Setting stations that can be received in addition to the ones displayed, refer to Selecting the frequency manually page 136.

Changing the selection criterion

1. Move the highlight marker to the second field from the top.
2. Select the selection criterion.



Sampling stations, scan

The displayed stations in the current waveband are automatically sampled in succession.

1. Select "FM" or "AM".
2. Select the selection criterion.
3. Press the MINI joystick. Other menu items are displayed.
4. Select "Scan".



The stations are sampled.

Stop sampling:

1. Press the MINI joystick.
2. Select "Scan" again.

Station sampling is interrupted and the selected station stays on.

Buttons on the CD player

◀ ▶ To sample stations, press the button for the corresponding direction for an extended time.

Press the button again to end the procedure.

Selecting the frequency manually

In "Manual" mode, you can set stations in addition to the ones displayed.

1. Select "FM" or "AM".
2. Move the highlight marker to the second field from the top.
3. Select "Manual".

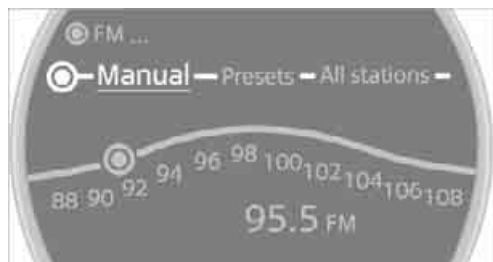

4. Turn the MINI joystick to set a certain frequency.

Updating stations with best reception

If on a longer journey you move out of the reception range of the stations originally received, you can update the list of stations with the best reception in the AM waveband.

1. Select "AM".
2. Move the highlight marker to the second field from the top.
3. Select Autostore, e.g. "Autostore".

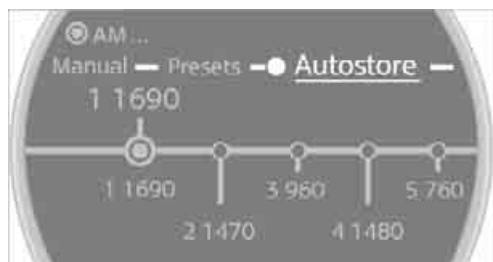

4. Press the MINI joystick. Other menu items are displayed.

5. Select "Autostore".



The display of the stations with the strongest reception is updated. The frequencies of the stations are displayed.

STORING STATIONS

1. Select "FM" or "AM".
2. Move the highlight marker to the second field from the top. Select the desired selection criterion.
3. Select the desired frequency or station.

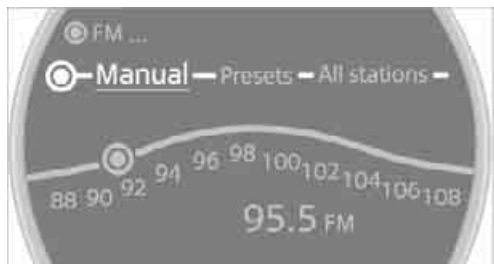

4. Press the MINI joystick. Other menu items are displayed.
5. Select "Store".



"Presets" is displayed.

6. Turn the MINI joystick until the desired memory location is selected. The number of the memory location appears beside the name or frequency of the station.



7. Press the MINI joystick. The station is stored.

The channels of the last selection criterion are displayed again after a short time.

The stations are stored for the remote control currently in use, refer to Personal Profile, page 26.

Changing a memory location

1. Select "Presets".
2. Select the desired station.
3. Press the MINI joystick. Other menu items are displayed.
4. Select "Store".



5. Turn the MINI joystick until the desired memory location is selected. The number of the memory location appears beside the name or frequency of the station.
6. Press the MINI joystick. The station is stored.

RADIO DATA SYSTEM RDS

Radio stations in the FM waveband can broadcast additional information, e.g. the station name, using RDS. If the reception conditions are good, the station names are shown on the Control Display. Where reception is poor or in the event of interference, it may take some time before the station names will appear in the display.

Switching RDS on/off*

1. Select "FM".
2. Press the MINI joystick. Other menu items are displayed.
3. Select "RDS".

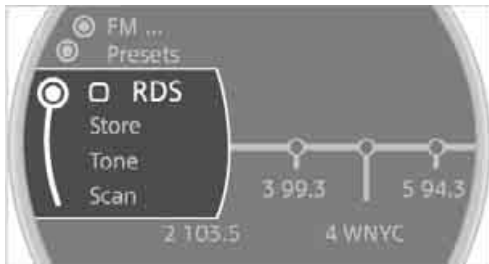

RDS is activated.

The setting is stored for the remote control in use, refer to Personal Profile, page 26.

HD RADIO*

Many stations broadcast both analog and digital signals. If a digital radio network is available, these stations can be received digitally and thus with better sound quality.

License conditions

HD Radio™ technology manufactured under license from iBiquity Digital Corp. U.S. and foreign Patents. HD Radio™ and the HD and HD Radio logos are proprietary trademarks of iBiquity Digital Corp.

Switching digital radio reception on/off

Onboard monitor, for operating principle refer to page 16.

1. Press the button. This opens the start menu.
2. Move the MINI joystick to highlight "Setup" and press the MINI joystick.
3. Select "Settings".



4. Select "Audio".
5. Change to the topmost field. Select "HD radio".



6. Select "Off".
 - The reception of digital stations is activated.

This symbol is displayed in the status line when a station is received digitally.



Some stations do not transmit the digital and analog signals simultaneously. If you are in an area in which digital reception of the selected station is not possible continuously, reception will alternate between analog and digital. This can cause repetitions or interruptions. In this case it may be preferable to switch off digital reception.

Selecting programs of a digital station*

Some stations broadcast several programs on a single frequency. To select one of these programs:

1. Select "FM" or "AM".



2. Select "Manual".
3. Select a station that can be received digitally.
 HD This symbol is displayed in the status line when a station is received digitally.
4. ◀ ▶ Change to the next program of the digital station using the buttons on the radio or steering wheel.

Updating digitally receivable stations

If on a longer journey you move out of the reception range of the stations originally received, you can update the list of stations received with the strongest signals.

1. Select "FM" or "AM".
2. Move the highlight marker to the second field from the top.

3. Select "Autostore".

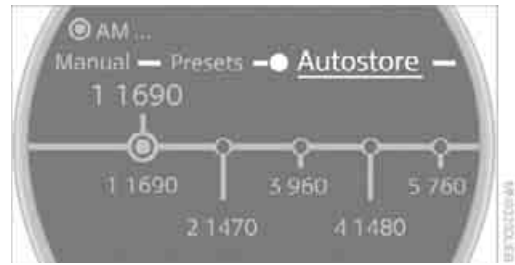

4. Press the MINI joystick. Other menu items are displayed.
5. Select "Autostore HD".



The display of the digitally receivable stations is updated. This can take up to 2 minutes.

Displaying additional information

With digital stations, additional information on the current track can be displayed, e.g. the name of the artist.

1. Select a station.
2. Select "Details".

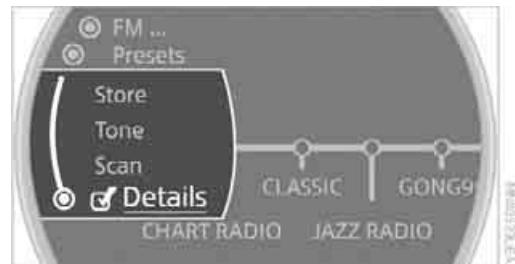

3. ✓ The information is displayed.

When you change to another digitally received station, any additional information is displayed after a brief interruption.

SATELLITE RADIO*

You can receive over 100 different channels with high sound quality.

The channels are offered to you in predefined packages. To receive the channels of your choice, you must have the corresponding packages enabled.

▶ With this new technology, signal losses can occur from time to time and result in audio interruptions. ◀

Enabling or disabling channels

Onboard monitor, for operating principle refer to page 16.

1. Press the  button. This opens the start menu.
2. Move the MINI joystick to highlight "Entertainment" and press the MINI joystick.
3. Select "SAT".



4. Press the MINI joystick.

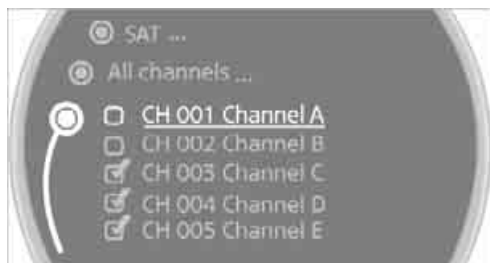

The channels are displayed.
 ✓ These channels are enabled.

Enabling

1. Select a channel that has not yet been enabled.

A phone number and the electronic serial number, ESN, are displayed.

▶ The electronic serial number is required to enable or disable a channel. ◀

2. To enable the channel:
Dial the phone number.

Disabling

1. Select an enabled channel.



2. Select "ESN".
The electronic serial number, ESN, is displayed.

▶ The electronic serial number is required to disable a channel. ◀

3. To disable the channel:
Dial the phone number.

Selecting and storing a channel

1. Select "SAT".



Channels are shown on the Control Display, sorted on the basis of selection criteria.

2. Select a menu item:
 - ▷ "Presets":
Up to twelve channels that you have memorized previously.
 - ▷ "All channels":
All channels are displayed.
 - ▷ "Categories":
All channels, arranged according to categories, e.g. News, Jazz.



3. Press the MINI joystick.
4. If "Categories" was selected:
Select the desired category.



The channels of this category are displayed.

5. ✓ Select a channel marked with this symbol.



6. Press the MINI joystick.
The selected station is played.

Additional information

1. Select a channel.
2. Select "Details".



The name of the channel and additional information on the current track are displayed, e.g. the name of the artist.

Storing a channel

1. Select the desired channel.
2. Press the MINI joystick.
Other menu items are displayed.
3. Select "Store".



"Presets" is displayed.

- Turn the MINI joystick to select the memory location and press the MINI joystick.



The channel is stored. The channels of the last selection criterion are displayed again after a short time.

Changing channels with buttons next to CD player

◀ ▶ Press the button for the corresponding direction.

The system switches to the next enabled channel.

Notes

When more than 4 seconds go by and no signal is received, a message appears on the Control Display.

▶ Under some circumstances, e.g. depending on environmental or topographic conditions, it may not be possible to receive any signal. The satellite radio has no influence on this. Signal may be unavailable in tunnels or underground garages, next to high-rise buildings, in the vicinity of trees, mountains or other strong sources of radio interference.

Reception usually resumes as soon as the signal becomes available again. ◀

CD PLAYER AND CD CHANGER*

LISTENING TO CDS

Compressed audio files*

CDs with compressed audio files, MP3s, can be played by the CD player and CD changer.

Starting the CD player

The upper drive is for audio CDs.

Insert the CD into the drive with the labeled side up.

The CD is drawn in automatically. Playback starts automatically if the sound output is on. When playing CDs with compressed audio files, it can take the CD player approx. 1 minute to read in the data, depending on the directory structure.

Starting playback of an inserted CD

Onboard monitor, for operating principle refer to page 16.

1. Press the  button. This opens the start menu.
2. Move the MINI joystick to highlight "Entertainment" and press the MINI joystick.
3. If necessary, move the highlight marker to the uppermost field. Select "CD".



4. If necessary, move the highlight marker to the second field from the top. In vehicles

with a CD changer, select "CD" to start the CD player.



Playback starts automatically if the sound output is switched on.

Starting the CD changer

1. Fill the CD changer, page 146.
2. Press the  button. This opens the start menu.
3. Move the MINI joystick to highlight "Entertainment" and press the MINI joystick.
4. If necessary, move the highlight marker to the uppermost field. Select "CD".
5. If necessary, move the highlight marker to the second field from the top. Select the desired CD.



At the end of the last track, the next CD is selected and played.

If new CDs have been placed in the CD changer, playback starts with the lowest CD, e.g. CD 1, track 1.

The CD changer's load status is indicated on the Control Display.

SELECTING A TRACK

Buttons on the CD player

◀ ▶ Press the button for the desired direction repeatedly until the desired track on the current CD is reached.

Playback of the CD starts at the beginning of the track. The track is displayed on the Control Display.

You can also change the track using the buttons on the steering wheel, page 11.

Using the onboard monitor

Turn the MINI joystick to select a track.



Compressed audio files*

1. Select the directory if necessary.



2. Select a track and press the MINI joystick.



To change the directory:

Select a directory and press the MINI joystick.

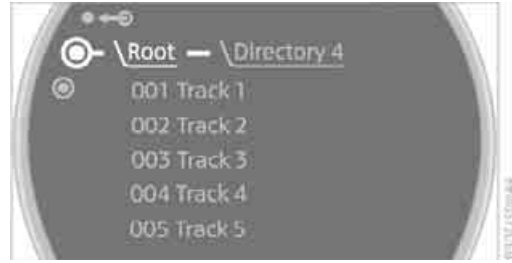

Exit the menu:

↩ Select the arrow.

Displaying information about the track*

With compressed audio files, any information about the current track that has been recorded can be displayed, e.g. the name of the artist.

1. Press the MINI joystick.
2. Select "Details".



The information is shown for the current track. The setting is stored for the remote control currently in use, refer to Personal Profile, page 26.

SAMPLING TRACKS, SCAN

All tracks on the current CD are automatically sampled once in succession.

1. Select a track.
2. Press the MINI joystick.
Other menu items are displayed.



3. Select "Scan".



Stop sampling:

1. Press the MINI joystick.
2. Select "Scan".

Track sampling is interrupted and the selected track is played on.

Compressed audio files*

1. Select the current track.
2. Select the desired menu item:
 - ▶ To scan all tracks in the current directory: Select "Scan directory".
 - ▶ To scan all tracks on the CD: select "Scan all".



Stop sampling

1. Press the MINI joystick.
2. Select "Scan directory" or "Scan all".

Sampling is interrupted and the selected track is retained.

REPEATING TRACKS

1. Select a track.
2. Press the MINI joystick.
Other menu items are displayed.



3. Select "Repeat".



The current track on the CD is repeated.

Stop repeating

1. Press the MINI joystick again.
2. Select "Repeat".

Compressed audio files*

1. Select the current track.
2. Select the desired menu item:
 - ▷ To repeat the selected track: select "Repeat track".
 - ▷ To repeat all tracks in the current directory: select "Repeat directory".



Stop repeating

1. Press the MINI joystick.
2. Select "Repeat track" or "Repeat directory".

RANDOM PLAY SEQUENCE

The tracks on the current CD are played once each in random order.

1. Select a track.
2. Press the MINI joystick. Other menu items are displayed.
3. Select "Random".

Stop random function

1. Press the MINI joystick.
2. Select "Random".

Compressed audio files*

1. Select the current track.
2. Select the desired menu item:
 - ▷ To play back the tracks in the current directory in random order: select "Random directory".
 - ▷ To play back all tracks on the CD in random order: select "Random all".

Stop random function

1. Press the MINI joystick.
2. Select "Random directory" or "Random all".

FAST FORWARD/REVERSE

Buttons on the CD player:

- ◀ ▶ Press and hold the button for the corresponding direction. The tracks can be heard, but reproduction is distorted.

CD CHANGER



The MINI CD changer for 6 CDs is installed in the dashboard.

- ▶ When loading CDs into or removing them from the CD changer, hold them at their edges and do not touch the reflective signal-sensing area. ◀

Opening

Briefly press the bottom edge of the cover.

Closing

Push the cover back into its original position.

- ⚠ To prevent injury in the event of an accident, close the cover after use while the vehicle is being driven. ◀

Controls and displays

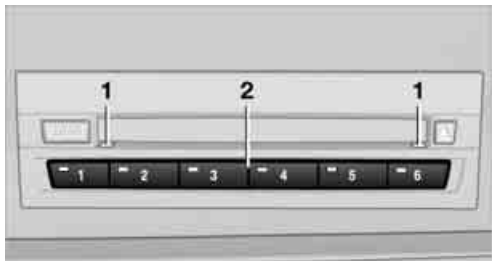

- 1 LEDs at the CD slot
LEDs flash when a CD can be inserted.
- 2 Buttons for CD compartments
LED is lit when a CD is in the compartment.

Filling the CD changer

1. Press the **LOAD** button.
The LED on the first empty compartment flashes.
2. To select another compartment if necessary:
Press the **1 ... 6** button.
3. When the LEDs 1 next to the CD slot flash, insert a single CD.
The CD is drawn in automatically and is placed in the selected CD compartment.

 Only insert the CD when the LEDs 1 next to the CD slot are flashing; otherwise, the CD or CD changer may be damaged.
Do not push the CD while it is being drawn in as this may cause it to jam and become impossible to eject. ◀

4. To fill additional CD compartments:
Repeat steps 1-3.
5. Close the cover after the CDs have been fully drawn in.

Filling empty CD compartments

1. Press the **LOAD** button for a longer period.
The LEDs on the empty CD compartments flash.
2. When the LEDs 1 next to the CD slot flash, insert a single CD.
The CD is drawn in automatically and is placed in the first vacant CD compartment.

 Only insert the CD when the LEDs 1 next to the CD slot are flashing; otherwise, the CD or CD changer may be damaged.

Do not push the CD while it is being drawn in as this may cause it to jam and become impossible to eject. ◀

3. Wait for the CD to be drawn in.
4. To fill additional CD compartments:
Repeat steps 2 and 3.
5. Close the cover after the CDs have been fully drawn in.

Removing CDs from the CD changer

1. Press the  button.
2. Press the **1 ... 6** button to select the CD compartment.
The CD is partially ejected from the CD changer.
3. Remove the CD.
4. Close the cover after the CDs have been removed.

Removing all CDs from the CD changer

1. Press the  button for a longer period.
The CDs are partially ejected from the CD changer one after the other.
2. Remove the CDs.
3. Close the cover after the CDs have been removed.

Malfunction

If all LEDs on the CD changer are flashing rapidly, there is a malfunction.

To solve the problem:

1. Press button **LOAD** or .
2. Remove the CD.

If the LEDs stop flashing rapidly, the CD changer is operational again.

NOTES



MINI CD/DVD players and changers are officially designated Class 1 laser products. Do not operate if the cover is damaged; otherwise, severe eye damage can result.

Do not use self-recorded CDs/DVDs with labels applied as these can become detached during playback due to heat build-up and can cause irreparable damage to the device.

Only use round CDs/DVDs with a standard diameter of 4.7 in/12 cm and do not play CDs/DVDs with an adapter, e.g. Single-CDs; otherwise, the CDs or the adapter can jam and will no longer eject.

Do not use a combined CD/DVD, e.g. DVD^{Plus}; otherwise, the CD/DVD can jam and will no longer eject. ◀

General malfunctions

MINI CD/DVD changers and players have been optimized for performance in vehicles. In some instances they may be more sensitive to faulty CDs/DVDs than stationary devices would be.

If a CD/DVD cannot be played, first check if it has been inserted correctly.

Humidity

High levels of humidity can lead to condensation on the CD/DVD or the laser's scan lens and temporarily prevent playback.

Malfunctions with individual CDs/DVDs

If malfunctions only occur with individual CDs/DVDs, one of the following factors may be the cause.

Self-recorded CDs/DVDs

Possible reasons for malfunctions with self-recorded CDs/DVDs are inconsistent data-creation or recording processes, or poor quality or old age of the CD/DVD blank.

Only label CDs/DVDs on the top, with a pen designed for this purpose.

Dirty or damaged CDs/DVDs

Avoid leaving fingerprints, as well as dust, scratches or moisture on the CDs/DVDs.

Keep CDs/DVDs in protective sleeves or cases. Do not expose CDs/DVDs to temperatures above 122 °F /50 °C, high humidity, or direct sunlight.

CDs/DVDs with copy protection

CDs/DVDs are often copy-protected by the manufacturer. This can mean that some CDs/DVDs cannot be played or can only be played to a limited extent.

AUX-IN PORT

You can connect an external audio device, for instance an MP3 player, and play audio tracks over the car's speaker system. You can adjust the tone on the onboard monitor.

CONNECTING



Connection for audio playback:
TRS connector 1/8"/3.5 mm.

To play audio tracks over the car's speaker system, connect the headset or line-out port of the external device to the AUX-IN port.

STARTING AUDIO PLAYBACK

The audio device must be switched on.

Onboard monitor, for operating principle refer to page 16.

1. Press the  button.
This opens the start menu.
2. Move the MINI joystick to highlight "Entertainment" and press the MINI joystick.

3. Select "AUX".



4. Select "AUX IN".
5. Adjust volume and tone, if necessary.

USB AUDIO INTERFACE*

CONNECTIONS FOR EXTERNAL DEVICES

An external audio device or USB device can be connected to the USB audio interface, for example:

- ▷ MP3 player
- ▷ USB memory stick
- ▷ iPod/iPhone
- ▷ Suitable mobile phone

If they are supported by the USB audio interface, these devices can be controlled using the onboard monitor.

If the mobile phone has a music player connection, connect the mobile phone using the snap-in adapter, refer to the separate Owner's Manual. Audio playback is only possible if there is no device connected to the USB audio interface.

The standard audio formats, e.g. MP3, WMA, WAV (PCM) and AAC, and playlists in the M3U format can be played.

Due the variety of audio devices and iPods on the market, it cannot be guaranteed that every device will be operable on the vehicle.

Ask your MINI Service which audio devices, mobile phones or USB devices are suitable.

Connecting via the USB audio interface

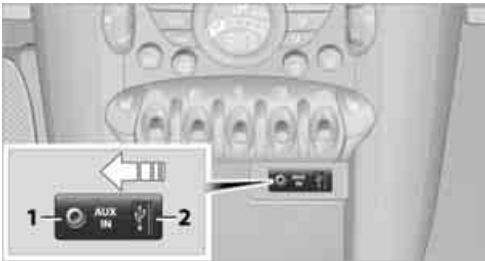

- 1 Connection for audio playback: TRS connector 1/8"/3.5 mm
- 2 USB interface

Apple iPod/iPhone

To connect the device, use the special cable adapter for the Apple iPod/iPhone, available from your dealer. The cable adapter is required for a flawless connection.

For additional information, contact your MINI dealer or visit the Internet at www.MINI.com/usb

To play audio tracks over the car's speaker system, connect the iPod/ iPhone to ports **1** and **2**.

The iPod/iPhone's menu structure is supported by the USB audio interface.

USB device

To play audio tracks over the car's speaker system, connect the USB device to port **2**.

After the device is connected for the first time, the track information (e.g. artist, type of music) and the playlists are transferred from the USB device to the vehicle. This procedure may take some time. The duration depends on the USB device and the number of tracks.

During transfer, you can call up the tracks using the directories and file names.

After transfer, you can also call up the tracks using the information and playlists.

Track information from up to four USB devices or for approx. 16,000 tracks can be stored on the vehicle.

If a fifth USB device is connected or if more than 16,000 tracks are to be stored, the information on existing tracks is deleted.

▷ Music tracks with integrated Digital Rights Management (DRM) cannot be played. ◀

STARTING AUDIO PLAYBACK

1. Press the  button. This opens the start menu.
2. Move the MINI joystick to highlight "Entertainment" and press the MINI joystick.

3. Select "AUX" and press the MINI joystick.



4. Select "USB" or the name of the audio device and press the MINI joystick.

Playback begins with the first track.

When you connect an iPhone via the snap-in adapter and an audio device to the AUX-IN port, the audio signal from the AUX-IN port is played.

SELECTING A TRACK

You can call up the tracks using the playlists and information. With USB devices you can also call up tracks using the file directory. The tracks can be displayed if they have been stored in the Latin alphabet.

1. Select the one you want, e.g. "Playlists" or "Artists" and press the MINI joystick.



2. Select a track and press the MINI joystick.

Displaying information about the track

Any information about the current track that has been recorded can be displayed, e.g. the name of the artist.

1. Press the MINI joystick during playback.
2. Select "Details" and press the MINI joystick.

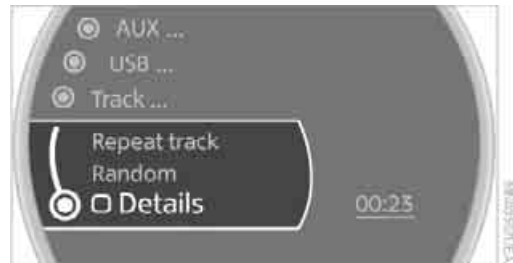

Information on the current track is displayed.

REPEATING TRACKS

1. Select a current track and press the MINI joystick.
2. Select "Repeat track" and press the MINI joystick.

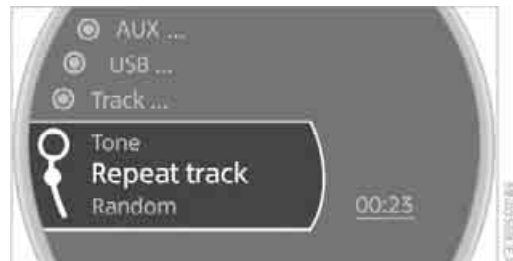

Stop repeating:

1. Press the MINI joystick.
2. Select "Repeat track" and press the MINI joystick.

RANDOM PLAY SEQUENCE

You can play the tracks in the selected list in random order, e.g. all tracks of a single artist.

1. Select a current track and press the MINI joystick.
2. Select "Random" and press the MINI joystick.

Stop random play:

1. Press the MINI joystick.
2. Select "Random" and press the MINI joystick.

FAST FORWARD/REVERSE

Buttons on the steering wheel or CD player:

Press and hold the   button for the corresponding direction.

NOTES

 Do not expose the audio device to extreme environmental conditions, e.g. very high temperatures, refer to the Owner's Manual of the audio device. Otherwise, the audio device may become damaged, which could compromise safety while driving. ◀

Depending on the configuration of the audio files, e.g. bit rates greater than 256 kbit/s, the files may not play back correctly in every case.

Notes on connecting

- ▷ The USB audio interface supplies the connected audio devices with power, provided that this is supported by the audio device. Therefore, do not connect the USB audio device to the power socket in the vehicle during operation.
- ▷ Do not forcibly connect the plug to the USB interface.
- ▷ Do not connect devices such as fans or lamps to the USB audio interface.
- ▷ Do not connect USB hard disks.
- ▷ Do not use the USB audio interface to charge external devices.



AT A GLANCE

CONTROLS

DRIVING TIPS

NAVIGATION

ENTERTAINMENT

MOBILITY

REFERENCE

REFUELING

⚠ Switch off the engine before refueling; otherwise, fuel cannot be added to the tank and a message will be displayed. ◀

⚠ Take all precautionary measures and observe all applicable regulations when handling fuel. Do not carry any spare fuel containers in your vehicle. They can develop a leak and cause an explosion or cause a fire in the event of an accident. ◀

FUEL FILLER FLAP

Opening

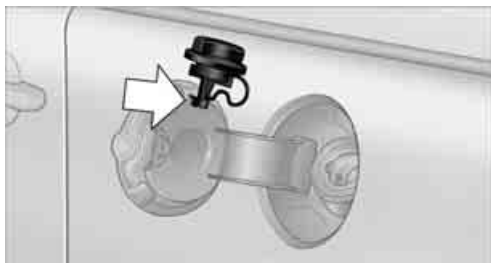

1. Open the fuel filler flap.
2. Turn the gas cap counterclockwise.
3. Place the gas cap in the bracket attached to the fuel filler flap.

Closing

Fit the cap and turn it clockwise until you clearly hear a click.

⚠ Do not pinch the band attached to the cap; otherwise, the cap cannot be closed properly and fuel vapors can escape. A message will be displayed if the gas cap is loose or missing. ◀

Manually releasing the fuel filler flap

In the event of an electrical malfunction, you can manually unlock the fuel filler flap:

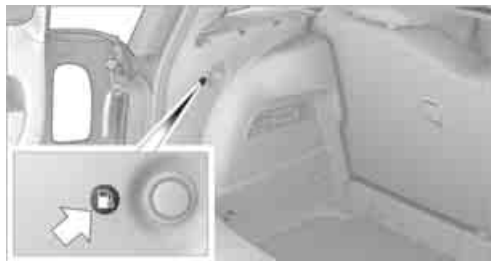

Pull on the green knob with the fuel pump symbol; the fuel filler flap opens.

Observe the following when refueling

⚠ Take all precautionary measures and observe all applicable regulations when handling fuel; otherwise, there is a danger of personal injury and property damage. ◀

When refueling, insert the filler nozzle completely into the filler pipe. Avoid lifting the filler nozzle while filling the tank, as that would lead to

- ▷ premature pump shutoff
- ▷ reduced efficiency of the fuel-vapor recovery system.

The fuel tank is full when the filler nozzle clicks off the first time.

Fuel tank capacity

⚠ If the range displayed is less than 30 miles/50 km, be sure to refuel; otherwise, engine functions are not guaranteed and damage could occur. ◀

Approx. 13.2 US gallons/50 liters, including the reserve capacity of 2.1 US gallons/8 liters.

FUEL SPECIFICATIONS

 Do not use leaded gasoline; otherwise, permanent damage to the catalytic converter will result.

Do not fill the tank with E85, i.e. fuel containing 85 % ethanol, nor with FlexFuel. Otherwise, the engine and fuel supply system will be damaged. ◀

Required fuel

Super Premium gasoline/AKI 91

This gasoline is highly recommended.

However, you may also use gasoline with less AKI. The minimum AKI Rating is:

- ▷ Cooper S, John Cooper Works: 89
- ▷ Cooper: 87

If you use gasoline with this minimum AKI Rating, the engine may produce knocking sounds when starting at high outside temperatures. This has no effect on the engine life.

 Do not use any gasoline below the specified minimum fuel grade. Otherwise, the engine could be damaged. ◀

Use high-quality brands

Field experience has indicated significant differences in fuel quality: volatility, composition, additives, etc., among gasolines offered for sale in the United States and Canada. Fuels containing up to and including 10% ethanol or other oxygenates with up to 2.8% oxygen by weight, that is, 15% MTBE or 3% methanol plus an equivalent amount of co-solvent, will not void the applicable warranties with respect to defects in materials or workmanship.

 The use of poor-quality fuels may result in drivability, starting and stalling problems especially under certain environmental conditions such as high ambient temperature and high altitude.

Should you encounter drivability problems which you suspect could be related to the fuel you are using, we recommend that you respond by switching to a recognized high-quality brand

such as gasoline that is advertised as Top Tier Detergent Gasoline.

Failure to comply with these recommendations may also result in unscheduled maintenance. ◀

WHEELS AND TIRES

TIRE INFLATION PRESSURES

Information for your safety

It is not merely the tires' service life, but also driving comfort and, to a great extent, driving safety that depend on the condition of the tires and the maintenance of the specified tire pressure.

Checking pressure

 Check the tire inflation pressure regularly and correct it, if necessary: at least twice a month and before starting long trips. If you fail to observe this precaution you may be driving on tires with incorrect tire pressures, a condition that can not only compromise your vehicle's driving stability, but also lead to tire damage and the risk of an accident. Do not drive with deflated, i.e. flat tires, except when using run-flat tires. A flat tire will seriously impair your vehicle's handling and braking response. Attempts to drive on a flat tire can lead to loss of control over the vehicle. ◀

Check the tire inflation pressures only on cold tires. This means after a maximum of 1.25 miles/ 2 km driving or when the vehicle has been parked for at least 2 hours. When tires are warm, the tire inflation pressure is higher.

 After adjusting the tire inflation pressure, reinitialize the flat tire monitor, page 74, or reset the Tire Pressure Monitor, page 76. ◀

Checking the tire inflation pressure of the compact tire*

To check the inflation pressure, fold up the level load floor. Remove the onboard vehicle tool kit and the space-saver spare tire, refer to page 183.

Inflation pressure specifications

The tables below provide all the correct inflation pressures for the specified tire sizes at ambient temperature.

 The tire inflation pressures apply to the tire sizes approved and the tire brands recommended by the manufacturer of your MINI. Your MINI dealer will be glad to advise you. ◀

For correct identification of the right tire inflation pressures, observe the following:

- ▷ Tire sizes for your vehicle
- ▷ Load conditions
- ▷ Maximum allowable driving speed

Tire inflation pressures for driving up to 100 mph or 160 km/h

For normal driving up to 100 mph or 160 km/h and to achieve optimum driving comfort, adjust pressures to the respective tire inflation pressures listed on the following pages in the columns for traveling speeds up to a maximum of 100 mph or 160 km/h.

These tire inflation pressures can also be found on the driver's side door post when the driver's door is open.



 The maximum permitted speed for these tire inflation pressures is 100 mph or 160 km/h. Do not exceed this speed; otherwise, tire damage and accidents may occur. ◀

Tire inflation pressures for driving above 100 mph or 160 km/h

 In order to drive at maximum speeds in excess of 100 mph or 160 km/h, adjust pressures to the respective tire inflation pressures listed on the following pages in the col-

umns for traveling speeds including those exceeding 100 mph or 160 km/h. Otherwise, tire damage and accidents could occur. ◀

Observe all national and local maximum speed limits; otherwise, violations of the law could occur.

MINI Cooper Clubman tire inflation pressures

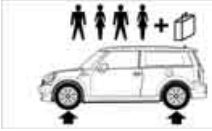
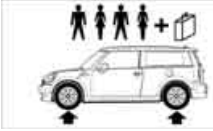
Tire size	Pressure specifications in psi/kPa			
	Speeds up to a max. of 100 mph/160 km/h		Speeds including those exceeding 100 mph/160 km/h	
All pressure specifications in the table are indicated in psi/kilopascal with cold tires. Cold = ambient temperature				
	<hr/>			
195/55 R 16 87 H				
195/55 R 16 87 H RSC				
195/55 R 16 87 H M+S RSC	32/220	32/220	35/240	38/260
195/55 R 16 87 V M+S RSC				
<hr/>				
175/65 R 15 84 T M+S				
175/65 R 15 84 H M+S				
175/65 R 15 84 H				
175/60 R 16 82 H M+S RSC	35/240	35/240	38/260	41/280
205/45 R 17 84 V RSC				
205/45 R 17 84 V M+S RSC				
205/40 R 18 82 W RSC				
<hr/>				
Emergency wheel: 115/70 R 15 90 M	60/420	60/420	60/420	60/420
<hr/> More details on the permissible load and weights can be found on page 194.				

MINI Cooper S Clubman tire inflation pressures

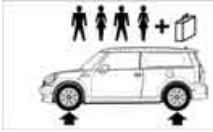
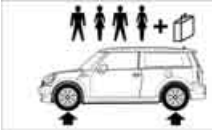
Tire size	Pressure specifications in psi/kPa			
	Speeds up to a max. of 100 mph/160 km/h		Speeds including those exceeding 100 mph/160 km/h	
All pressure specifications in the table are indicated in psi/kilopascal with cold tires. Cold = ambient temperature				
	195/55 R 16 87 V RSC	35/240	35/240	38/260
195/55 R 16 87 H M+S RSC				
195/55 R 16 87 V M+S RSC				
205/45 R 17 84 V RSC				
205/45 R 17 84 V M+S RSC				
205/40 R 18 82 W RSC	38/260	38/260	41/280	44/300
175/60 R 16 82 H M+S RSC				
More details on the permissible load and weights can be found on page 194 .				

AT A GLANCE

CONTROLS

DRIVING TIPS

NAVIGATION

ENTERTAINMENT

MOBILITY

REFERENCE

MINI John Cooper Works Clubman tire inflation pressures

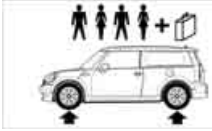
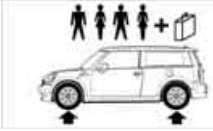
Tire size	Pressure specifications in psi/kPa			
	Speeds up to a max. of 100 mph/160 km/h		Speeds including those exceeding 100 mph/160 km/h	
<p>All pressure specifications in the table are indicated in psi/kilopascal with cold tires. Cold = ambient temperature</p>				
	185/50 R 17 86 H M+S XL RSC			
205/45 R 17 84 V M+S RSC	38/260	38/260	39/270	45/310
205/45 R 17 84 W RSC				
205/40 R 18 82 W RSC	41/280	41/280	42/290	48/330
<p>More details on the permissible load and weights can be found on page 194.</p>				

TIRE CODING

Knowledge of the labeling on the side of the tire makes it easier to identify and choose the right tires.

Tire size

Speed code letter

Q = up to 100 mph or 160 km/h

T = up to 118 mph or 190 km/h

H = up to 131 mph or 210 km/h

V = up to 150 mph or 240 km/h

W = up to 167 mph or 270 km/h

Y = up to 186 mph or 300 km/h

Tire Identification Number

Tires with DOT codes meet the guidelines of the US Department of Transportation.

DOT code:

Uniform Tire Quality Grading

For instance: DOT xxxx xxx 0810

Manufacturer's _____
code for tire make

Tire size and _____
tire design

Tire age _____

Quality grades can be found where applicable on the tire sidewall between tread shoulder and maximum section width. For example:

Tread wear 200 Traction AA

Temperature A

DOT Quality Grades

Tread wear

Traction AA A B C

Temperature A B C



All passenger car tires must conform to Federal Safety Requirements in addition to these grades. ◀

Tread wear

The tread wear grade is a comparative rating based on the wear rate of the tire when tested

under controlled conditions on a specified government test course. For example, a tire graded 150 would wear one and one-half (1 ½) times as well on the government course as a tire graded 100. The relative performance of tires depends upon the actual conditions of their use, however, and may depart significantly from the norm due to variations in driving habits, service practices and differences in road characteristics and climate.

Traction

The traction grades, from highest to lowest, are AA, A, B, and C.

Those grades represent the tire's ability to stop on wet pavement as measured under controlled conditions on specified government test surfaces of asphalt and concrete. A tire marked C may have poor traction performance.



The traction grade assigned to this tire is based on straight-ahead braking traction tests, and does not include acceleration, cornering, hydroplaning, or peak traction characteristics. ◀

Temperature

The temperature grades are A, the highest, B, and C, representing the tire's resistance to the generation of heat and its ability to dissipate heat when tested under controlled conditions on a specified indoor laboratory test wheel. Sustained high temperature can cause the material of the tire to degenerate and reduce tire life, and excessive temperature can lead to sudden tire failure. The grade C corresponds to a level of performance which all passenger car tires must meet under the Federal Motor Vehicle Safety Standard No. 109. Grades B and A represent levels of performance on the laboratory test wheel that exceed the minimum required by law.



The temperature grade for this tire is established for a tire that is properly inflated and not overloaded. Excessive speed, underinflation, or excessive loading, either separately or in combination, can cause heat buildup and possible tire failure. ◀

RSC - run-flat tires*

You will recognize run-flat tires by a circular symbol containing the letters RSC on the side of the tire, page 165.

M+S

Winter and all-season tires. These have better winter properties than summer tires.

XL

Designation for specially reinforced tires.

TIRE CONDITION

Inspect your tires regularly for tread wear, signs of damage and for foreign objects lodged in the tread. Check the tread depth.

Tread depth

The tread depth should not drop below 1/8 in/ 3 mm, although, for example, European legislation only specifies a minimum tread depth of 1/16 in/1.6 mm. At tread depths below 1/8 in/ 3 mm there is an increased risk of high-speed hydroplaning, even when only small amounts of water are present on the road surface.

Winter tires

When winter tires wear down past a tread depth of 1/6 in/4 mm, they become perceptibly less suitable for winter conditions. In the interest of safety, new tires should be installed.

Minimum tread depth

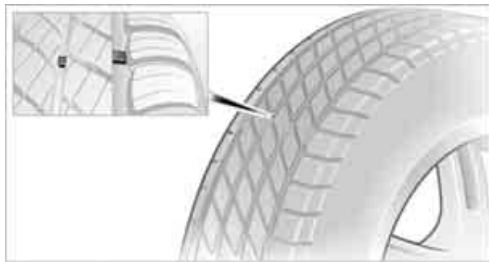

Wear indicators in the base of the tread groove are distributed around the tire's circumference;

the letters TWI, for Tread Wear Indicator, on the tire's sidewalls identify tires that incorporate these wear indicators. When tire tread is worn down to the level of the wear indicators, the remaining tread depth is 1/16 in/1.6 mm.

Tire damage

Due to low-profile tires, please note that wheels, tires and suspensions parts are more susceptible to road hazards and consequential damages.

Unusual vibrations encountered during normal vehicle operation can indicate tire failure or some other vehicle defect. This can, for example, be caused by driving over curbs. The same applies to any other abnormal road behavior, such as pulling severely to the right or left.



In these cases, reduce speed immediately and have wheels and tires thoroughly checked. To do so, drive carefully to the nearest MINI dealer or tire shop that works according to MINI repair procedures with correspondingly trained personnel. If necessary, have the vehicle towed there.

Otherwise, tire damage can be extremely dangerous for vehicle occupants and other road users. ◀

Tire age

The manufacturing date of tires is contained in the tire coding:

DOT ... 0810 means that the tire was manufactured in week 8 of 2010.

For various reasons, such as the development of brittleness, the manufacturer of your MINI recommends tire replacement after no more than 6 years, regardless of the actual wear of the tires.

RUN-FLAT TIRES*



The symbol identifying run-flat tires is a circle with the letters RSC on the sidewall. Run-flat tires comprise a conditionally self-supporting tire and a special rim. The reinforcement in the sidewalls ensures that the tire can continue to be used subject to certain restrictions, even if depressurized.

For information on continuing to drive with a flat tire, refer to Indication of a flat tire, page 74.

NEW WHEELS AND TIRES

 Have new wheels and tires mounted only by your MINI dealer or a specialized tire shop that has specially trained personnel working in accordance with the specifications of the MINI manufacturer. If this work is not carried out properly, there is a danger of subsequent damage and related safety hazards. Make sure that the new wheels are balanced. ◀

Retreaded tires

 The manufacturer of your MINI recommends that you avoid using retreaded tires, as this could impair driving safety. The causes for this include potentially different tire casing structures and often wide variations in tire age, which can result in a limited service life. ◀

Correct wheels and tires

 The manufacturer of your MINI recommends mounting only wheels and tires that it has specifically approved for use on your particular model. Although other wheels and

tires may theoretically have the same dimensions, variations in factors such as manufacturing tolerances can result in contact between tire and bodywork, ultimately leading to serious accidents. The manufacturer of your MINI cannot evaluate non-approved wheels and tires to determine if they are suited for use, and therefore cannot ensure the operating safety of the vehicle if they are mounted. ◀

Your MINI dealer will be glad to inform you about the correct wheel and tire combination for your vehicle.

The correct combination of wheels and tires is also necessary to ensure reliable operation of various vehicle systems such as ABS and DSC.

To maintain good handling and vehicle response, use only tires of a single brand and tread configuration. After a tire has been damaged, mount the previous wheel and tire combination again as soon as possible.

Wheels with Tire Pressure Monitor TPM electronics

When mounting new tires or changing over from summer to winter tires, or vice versa, only use wheels with TPM electronics; otherwise, the Tire Pressure Monitor may not be able to detect a puncture, refer to page 77. Your MINI dealer will be glad to advise you.

Recommended tire brands

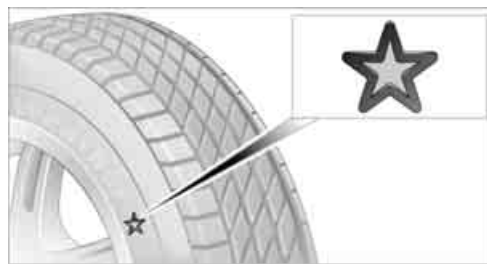

For each tire size, the manufacturer of your MINI recommends certain tire brands. They are marked with a clearly visible MINI designation on the sidewall of the tire.

When properly used, these tires meet the highest standards in terms of safety and handling characteristics.

Run-flat tires*

When mounting new tires or changing over from summer to winter tires and vice versa, mount run-flat tires for your own safety. Keep in mind that no space-saver spare tire is available in the event of a flat. Your MINI dealer will be glad to advise you.

Special characteristics of winter tires

The manufacturer of MINI recommends the use of winter tires on snowy roads or if temperatures drop below 45 °F / +7 °C. Although all-season M+S tires provide better winter traction than summer tires, they generally fail to provide the same levels of cold-weather performance as winter tires.

Pay attention to speed

 Always comply with the speed limit for the winter tires mounted on your car; failure to do so could result in tire damage and accidents. ◀

If the car is capable of speeds higher than that permitted for the winter tires, a label stating the maximum permitted speed for the mounted tires must be displayed in your field of view. Specialist tire dealers and your MINI dealer can supply these labels.

Storage

Always store wheels and tires in a cool, dry place with as little exposure to light as possible. Always protect tires against all contact with oil, grease and fuels.

Do not exceed the maximum tire inflation pressure indicated on the sidewall of the tire.

Swapping wheels among the axles

Depending on the individual use, front and rear tires may exhibit different wear and tear.

In order to maintain an even wear and tear, the wheels may be rotated between the axles. Your MINI dealer will be glad to advise you.

Always check the inflation pressure after the tire rotation, if necessary change the pressure.

SNOW CHAINS*

Only certain types of fine-link snow chains have been tested by the manufacturer of your MINI, classified as road-safe and recommended. Contact your MINI dealer for more details.

Only attach snow chains in pairs to the front wheels with the following tires.

▷ 175/65 R 15 M+S

▷ 175/60 R 16 M+S

John Cooper Works:

▷ 185/50 R 17 86 H M+S XL RSC

Observe the manufacturer's instructions when mounting snow chains. Do not exceed a speed of 30 mph or 50 km/h.

 Do not initialize the Flat Tire Monitor if snow chains are mounted; otherwise, the instrument might issue an incorrect reading. When driving with snow chains, it can be useful to briefly deactivate the DSC or activate the DTC, refer to page 72. ◀

UNDER THE HOOD

! Do not work on the car unless you possess the necessary technical knowledge. If you are not familiar with the regulations to be observed, have the necessary work on your vehicle carried out only by a MINI dealer or a workshop that has specially trained personnel working in accordance with the specifications of the MINI manufacturer. If this work is not carried out properly, there is a danger of subsequent damage and related safety hazards. ◀

HOOD

Releasing



Pull the lever.

! Do not clean the windshield and headlamps if the hood is unlocked as this may damage the headlamp washer system*. ◀

Opening



! To avoid damage, make sure that the wiper arms are against the windshield before you open the hood. ◀

Press the release handle and open the hood.

Closing

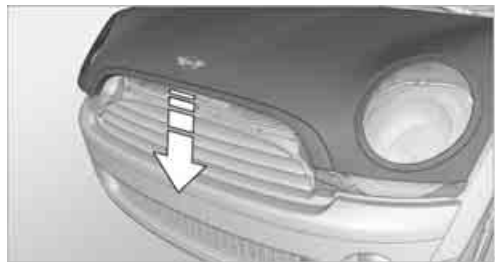

Close the hood from a height of approx. 16 in/ 40 cm with momentum. It must be clearly heard to engage.

! If you notice any signs while driving your vehicle that the hood is not completely closed, stop at once and close it securely. Make sure that the closing path of the hood is clear; otherwise, injuries may result. ◀

IMPORTANT PARTS OF THE ENGINE COMPARTMENT

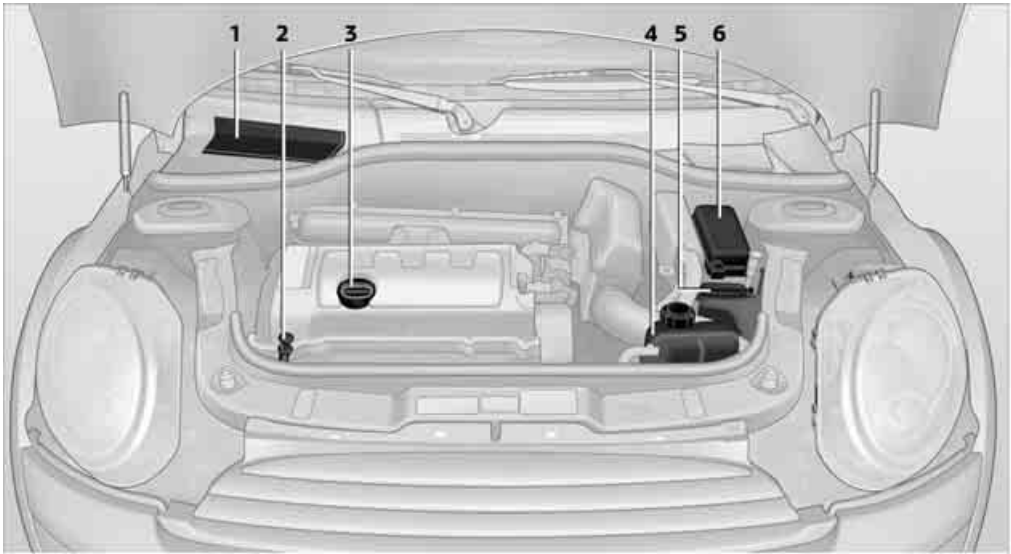

- | | |
|--|---|
| <p>1 Battery, under the cover 186</p> <p>2 Engine oil dipstick 168</p> <p>3 Engine oil filler neck 169</p> | <p>4 Coolant expansion tank 169</p> <p>5 Reservoir for washer fluid for the headlamp and window washer system 52</p> <p>6 Engine compartment fuse box 185</p> |
|--|---|

ENGINE OIL

The engine oil consumption is dependent on driving style and driving conditions.

Check the engine oil level regularly, e.g. when refueling.

Checking engine oil level

1. With the vehicle's engine at normal operating temperature, i.e. after uninterrupted driving for at least 6 miles/10 km, park the vehicle on a level surface.
2. Switch off the engine.
3. Pull the dipstick out after approx. 5 minutes and wipe it off with a lint-free cloth, paper towel or similar material.
4. Carefully push the dipstick all the way into the guide tube and pull it out again.

The oil level should be between the two marks on the dipstick.



The oil quantity corresponding to the difference between the two marks on the dipstick is 1 US quart/1 liter.

⚠ Do not fill beyond the upper mark on the dipstick. Excess oil will damage the engine. ◀

Adding engine oil

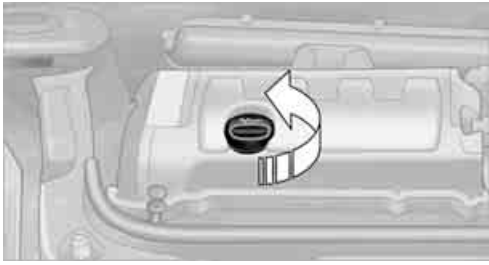

Do not add the maximum quantity of 1 US quart/1 liter of engine oil until the oil level has dropped to just above the lower mark on the dipstick, page 168.

 Add oil within the next 30 miles/50 km; otherwise, the engine could be damaged. ◀

 Keep oils, greases, etc. out of the reach of children and comply with the warnings on the containers. Otherwise, health hazards may result. ◀

Oil change

Have the oil changed only by a MINI dealer or a workshop that has specially trained personnel working in accordance with the specifications of the MINI manufacturer.

Oil types

 Do not use oil additives as this could result in engine damage. ◀

Approved engine oils

Your dealer can advise you on which engine oils have been approved by the manufacturer of your MINI.

The engine oil quality is critical for the life of the engine.

Only use approved High Performance oil.

 The approved oils are SAE 0W-40, 0W-30, 5W-40 and 5W-30. ◀

Alternative oil types

If the approved engine oils are not available, up to 1 US quart/1 liter of another oil with the following specification may be used:

API SM or higher

MINI RECOMMENDS 

COOLANT

 Do not add coolant to the cooling system when the engine is hot. Escaping coolant can cause burns. ◀

Coolant consists of half water and half additive. Not all commercially available additives are suitable for your MINI. Your MINI dealer knows which additives are suitable and will be glad to advise you.

 Only use suitable additives; otherwise, engine damage may result. Because additives are harmful to your health, it is important to follow the instructions on the containers. ◀

 Comply with the appropriate environmental protection regulations when disposing of coolant additives. ◀

Checking coolant level

1. Do not open the hood until the engine has cooled down.
2. Turn the cap of the expansion tank a little counterclockwise to allow any accumulated pressure to escape, then continue turning to open.
3. The coolant level is correct if it is between the Min and Max markings.
4. If the coolant is low, slowly add coolant up to the specified level; do not overfill.
5. Turn the cap until there is an audible click.
6. Have the reason for the coolant loss eliminated as soon as possible.

MAINTENANCE

MINI MAINTENANCE SYSTEM



The MINI Maintenance System supports the preservation of the traffic and operating safety of your MINI. The objective is to optimize efforts with respect to minimal vehicle maintenance costs.

If and when you come to sell your MINI, a comprehensive record of servicing will prove a significant benefit.

Condition Based Service CBS

Sensors and special algorithms take the different driving conditions of your MINI into account. Condition Based Service uses this to determine the current and future service requirements. By letting you define a service and maintenance regimen that reflects your own individual requirements, the system builds the basis for trouble-free driving.

On the Control Display, you can have the remaining times or distances for selected maintenance tasks and any legally prescribed dates displayed, page 60.

Service data in the remote control

Your vehicle continuously stores service-requirement information in the remote control while you are driving. Your MINI dealer can read out this data from the remote control unit, and propose an optimized maintenance approach. Whenever you take your car in for servicing you should therefore hand your MINI dealer the remote control unit that you last used.

 Make sure that the date is always set correctly, page 64; otherwise, the effectiveness of Condition Based Service CBS is not assured. ◀

Service and Warranty Information Booklet for US models and Warranty and Service Guide Booklet for Canadian models

Please consult your Service and Warranty Information Booklet for US models and Warranty and Service Guide Booklet for Canadian models for additional information on service requirements.

 The manufacturer of the MINI recommends that you have service and repair operations performed at your MINI dealer. Take the time to ensure that these service procedures are confirmed by entries in your vehicle's Service and Warranty Information Booklet for US models and Warranty and Service Guide Booklet for Canadian models. These entries verify that your vehicle has received the specified regular maintenance. ◀

SOCKET FOR ONBOARD DIAGNOSIS OBD

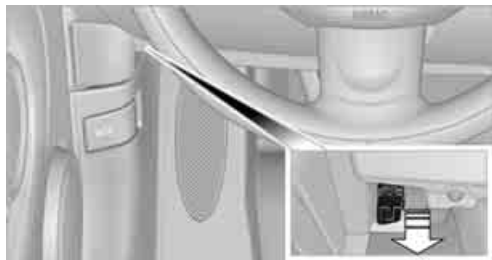

The primary components that make up the emissions can be checked by a device via the OBD socket.

EMISSIONS



The warning lamps come on. The vehicle is producing higher emissions. You can continue your journey, but moderate your speed and exercise due caution.



Have the car checked as soon as possible.

Under certain circumstances, one of the lamps will flash or light up continuously. This indicates excessive misfiring or a malfunction in the engine. If this happens, reduce your speed and visit the nearest MINI dealer as soon as possible. Severe misfiring can quickly lead to serious damage of emissions-related components, especially the catalytic converter. In addition, mechanical engine components can become damaged.



If the fuel filler cap is not properly tightened, the OBD system may conclude that fuel vapors are escaping, causing an indicator to light up. If the filler cap is then tightened, the indicator should go out within a few days.

Data memory

Your vehicle displays data about the operation, malfunctions, and user settings. These data are stored in the vehicle and can be partly stored in the remote control; the data can be read by suitable devices, in particular at your service center. The data read out are used for supporting the service processes and repair or for optimization and development of vehicle functions.

CARE

CAR-CARE PRODUCTS

Regular cleaning and care helps to maintain the value of your MINI.

The manufacturer of your MINI recommends using manufacturer-approved products to clean and care for your vehicle.

MINI Service would be pleased to advise you on cleaning and care products and services for your MINI.

 The ingredients of original MINI Care Products have been tested, and the products have been tested in the laboratory and in practice. They offer optimum care and protection for your vehicle. ◀

 Do not use any cleansers containing alcohol or solvents as these may cause damage. ◀

 Cleaning agents may contain hazardous or health-damaging substances. Follow the warning and hazard instructions on the packaging. For interior cleaning, always open the doors or windows of the vehicle. Do not use any products that are not intended for cleaning the vehicle. ◀

EXTERNAL CARE

Washing your vehicle

 Especially during the winter months the vehicle should be frequently washed. Dirt and road salt can damage the vehicle. ◀

 After washing the vehicle, apply the brakes briefly to dry them; otherwise, water can reduce braking efficiency over the short term and the brake rotors can corrode. ◀

Car washes

Preference should be given to cloth car washes.

 Do not use automatic high-pressure car washes; otherwise, water may drip into the vehicle around the windows. ◀

Before driving into the car wash, check if the system is suitable for your MINI. Observe the following points:

- ▷ Dimensions of the vehicle, page 193
- ▷ If necessary: fold in the outside mirrors, page 41.
- ▷ Maximum permissible tire width

 Avoid car washes with tracks higher than 4 in/10 cm; otherwise, the chassis could be damaged. ◀

Preparations for driving into the car wash:

- ▷ Unscrew the rod antenna.
- ▷ Deactivate the rain sensor* to prevent unintentional wiping.
- ▷ Deactivate the rear window wiper* and protect it from damage. Ask the car wash operator about measures that can be taken to protect the wipers.
- ▷ Remove additional attachments, e.g. spoilers or telephone antennas, if there is a possibility that they could be damaged.

Automatic transmission

Before driving into the car wash, make sure that the vehicle can roll:

1. Place the remote control, even with Comfort Access, in the ignition lock.
2. Move the selector lever to position N.
3. Release the parking brake.
4. Switch off the engine.
5. Insert the remote control in the ignition lock so that the vehicle can roll.

Steam jets/high-pressure washers

 When using steam jets or high-pressure washers, ensure that you maintain sufficient clearance to the vehicle and do not exceed a temperature of 140 °F /60 °C.

If the distance is too close, the pressure too high, or the temperature too high, parts of the vehicle can be damaged, or water can penetrate. Observe the operating instructions for high-pressure washers. ◀

 Do not spray sensors such as Park Distance Control with high-pressure washers for a long time or at a distance of less than 1 ft/30 cm. ◀

Manual washing

Use a great deal of water and, if necessary, car shampoo when washing your car by hand. Clean the vehicle with a sponge or a washing brush applying a slight amount of pressure.

 Before cleaning the windshield, deactivate the rain sensor or turn off the ignition to prevent unintentional wiping. ◀

 Observe local regulations regarding washing vehicles by hand. ◀

Headlamps

Do not wipe dry and do not use abrasive or corrosive cleaning agents. Remove dirt and contamination, such as insects, by soaking with shampoo and then washing with plenty of water.

Do not remove accumulated ice and snow with an ice scraper; use window deicers instead.

Windows

Clean the outside and inside of the windows and mirrors with a window cleaner.

 Do not clean the mirrors with cleaners containing quartz. ◀

Wiper blades

Clean with soapy water and change regularly to prevent the formation of streaks.

 Wax, preservatives and dirt on the windows cause streaks when the windshield wipers are on, and can cause premature wear of the wiper blades and interfere with the rain sensor. ◀

Paintwork, care

Regular care helps your vehicle retain its value and protects the paint from the long-term effects of aggressive substances.

In some regions, environmental factors can affect the vehicle paintwork and damage it. It is therefore important to adjust the frequency and extent of vehicle care correspondingly.

Immediately remove aggressive materials such as spilled fuel, oil, grease, brake fluid, tree sap or bird droppings to prevent damage to the paintwork.

Removing paintwork damage

 Depending on the severity of the damage, immediately repair stone damage or scratches to prevent rusting. ◀

The manufacturer of the MINI recommends repairing paint damage professionally according to factory specifications with original MINI paints.

Preservation

Preservation is necessary when water no longer beads on the clean paint surface. To preserve the paint, only use preservatives that contain carnauba or synthetic waxes.

Rubber seals

Only treat with water or rubber care products.

 Do not use silicon sprays or other silicon-containing care products on rubber seals; otherwise, noise and damage could occur. ◀

Chrome parts*

Carefully clean vehicle parts such as the radiator grill and door handles with copious quantities of water and, if necessary, a shampoo additive, especially when contaminated with road salt. For additional treatment, use chrome polish.

Light-alloy wheels*

The system produces brake dust that collects on the light alloy wheels. Clean them regularly with acid-free wheel cleaner.

 Do not use aggressive, acid-containing highly alkaline or abrasive cleansers or steam jets above 140 °F / 60 °C as they may cause damage. ◀

External sensors

 Keep the outside sensors on the vehicle such as the Park Distance Control clean and ice-free to ensure that they function properly. ◀

INTERNAL CARE

Upholstery/fabrics

Regularly use a vacuum cleaner to remove surface dirt.

In case of serious spots such as liquid stains, use a soft sponge or lint-free microfiber cloth and suitable interior cleaners. Observe the instructions on the packaging.

 Clean upholstery up to the seams. Do not rub forcefully. ◀

 Velcro fasteners on pants or other items of clothing can damage seat covers. Make sure that all Velcro fasteners are closed. ◀

Leather/leather coverings*

 The leather processed by the manufacturer of your MINI is a high-quality natural product. Light variations in the grain is one of the typical properties of natural leather. ◀

Dust and road grit in the pores and folds of the leather have an abrasive effect, leading to increased wear and causing the leather surface to become brittle prematurely. Use a cloth or vacuum cleaner to remove dust on a regular basis.

Especially when the leather has a light color, it should be cleaned regularly since it tends to get heavily soiled.

Treat the leather twice a year using a leather lotion since dirt and grease will gradually attack the leather's protective layer.

Carpets/floor mats*

Floor mats can be removed to be cleaned.

If the floor carpet becomes heavily soiled, clean with a microfiber cloth and water or textile cleaner. When doing so, rub forward and back in the driving direction; otherwise, the carpet may become matted.

Interior plastic parts

These include:

- ▷ Plastic surfaces
- ▷ Lamp glass
- ▷ Display panes
- ▷ Mat parts

Only clean with water and, if necessary, solvent-free plastic cleaners.

 Do not use solvents such as alcohol, lacquer thinner, cold cleaners, fuel, or similar, as these will damage the surfaces. ◀

Decorative strips*

Only clean decorative strips with moist cloths. Wipe dry with a soft cloth.

Safety belts

Dirty belt straps impede the reeling action and thus have a negative impact on safety.

 Do not clean chemically, as this may destroy the webbing. ◀

Displays

To clean displays such as radios or display elements, use a display cleaning cloth or a soft, non-scratching, lint-free cloth.

 Avoid pressing too hard when cleaning the display as this can cause damage. ◀

 Do not use chemical or abrasive household cleaning agents. Keep fluids of any kind away from the device. Surfaces or electrical components may otherwise become corroded or damaged. ◀

CD/DVD drives



Do not use cleaning CDs as this could damage parts of the drive. ◀

VEHICLE STORAGE

If you are not going to drive your car for more than three months, please ask for advice from your MINI dealer or a workshop that works according to MINI manufacturer specifications.

REPLACING COMPONENTS

ONBOARD VEHICLE TOOL KIT



Your vehicle comes with an onboard vehicle tool kit that varies with the equipment version; it is stored underneath the level load floor.

- ▷ Mobility System with onboard vehicle tool kit and tire change set* 180
- ▷ Tire change set with onboard vehicle tool kit for space-saver spare tire 183

WIPER BLADES

Changing the front wiper blades

1. Fold up the wiper arm.

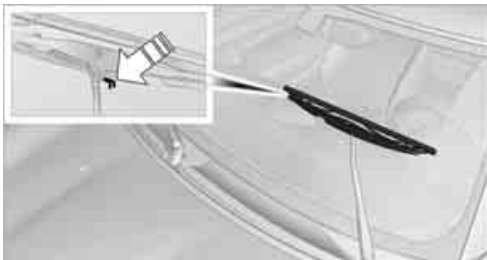

2. Position the wiper blade horizontally.
3. Press the securing spring, arrow.
4. Unhook the wiper blade toward the windshield.
5. Pull the wiper blade past the wiper arm toward the top.
6. Insert the new wiper blade.

7. Press into position until you hear it engage.
8. Fold down the wiper arm.

 To avoid damage, make sure that the wiper arms are against the windshield before you open the hood. ◀

Changing the rear wiper blade

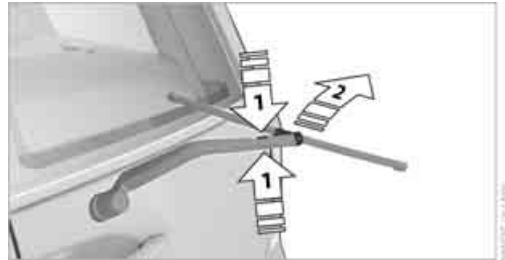

1. Fold out the wiper arm and hold it.
2. Press together the locking spring, arrow 1, and fold out the wiper blade.
3. Pull the wiper blade away from and out of the catch mechanism, arrow 2.
4. Press the new wiper blade into the fixture until it engages audibly.

LAMPS AND BULBS

Lamps and bulbs make an essential contribution to vehicle safety. They should, therefore, be handled carefully. The manufacturer of your MINI recommends having your MINI dealer perform any work that you do not feel competent to perform yourself or that is not described here.

 Never touch the glass of new bulbs with your bare fingers, as even minute amounts of contamination will burn into the bulb's surface and reduce its service life. Use a clean tissue, cloth or something similar, or hold the bulb by its base. ◀

You can obtain a selection of replacement bulbs at your MINI dealer.

 When working on electrical systems, always begin by switching off the consumer in question; otherwise, short circuits could result. To avoid possible injury or equipment damage when replacing bulbs, observe any instructions provided by the bulb manufacturer. ◀

Caring for headlamps, refer to page 173.

 For any bulb replacement not described below, contact a MINI dealer or a workshop that has specially trained personnel working in accordance with the specifications of the MINI manufacturer. ◀

 For checking and adjusting headlamp aim, please contact your MINI dealer. ◀

Light-emitting diodes LEDs

Light-emitting diodes installed behind translucent lenses serve as the light sources for many of the controls and displays in your vehicle. These light-emitting diodes are related to conventional laser diodes, and legislation defines them as Class 1 light-emitting diodes.

 Do not remove the covers or expose the eyes directly to the unfiltered light source for several hours; otherwise, this could cause irritation of the retina. ◀

Headlight glass lens

In cool or humid weather, condensation may occur on the interior of outside lights. The condensation disappears a short time after the light is switched on. Headlight glass lenses do not need to be replaced. If a lot of moisture is present, e.g. water droplets in the light, have them checked by your service center.

Xenon lamps*

The service life of these bulbs is very long and the probability of failure very low, provided that they are not switched on and off an excessive number of times. If a xenon lamp fails nevertheless, switch on the fog lamps and continue the journey with great care, provided that local legislation does not prohibit this.

 Have any work on the xenon lamp system, including bulb replacement, carried out only by a MINI dealer or a workshop that has specially trained personnel working in accordance with the specifications of the MINI manufacturer. Due to high voltage, there is a risk of fatal injury if work on the xenon lamps is carried out improperly. ◀

Halogen low beams and high beams

H13 bulb, 60/55 watts

 The H13 bulb is pressurized. Therefore, wear safety glasses and protective gloves. Otherwise, there is a risk of injury if the bulb is damaged. ◀

 Be careful when installing the cover; otherwise, leaks could occur and cause damage to the headlamp system. ◀

Accessing the lamp from the engine compartment

The low-beam/high-beam bulb can be changed from the engine compartment.

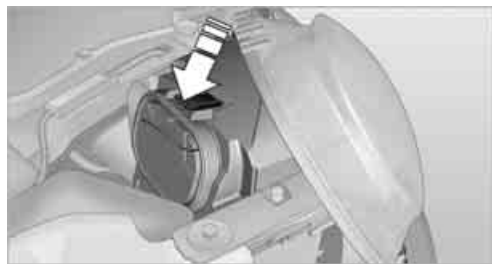

Removing the cover:

1. Press the tab.
2. Flip open the cover and take it out of the holder.

Follow the same steps in reverse order to reattach the cover.

 Be careful when installing the cover; otherwise, leaks could occur and cause damage to the headlamp system. ◀

Replacing the bulb

1. Turn the lamp counterclockwise, arrow 1, and remove it, arrow 2.

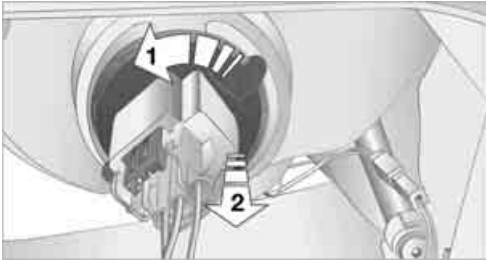

2. Push on the catch, arrow 1, and unplug the connector, arrow 2.

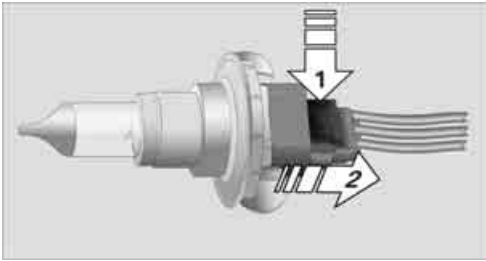

3. To insert the new bulb and replace the cover, proceed in reverse order.

Turn signal indicators, parking lamps, roadside parking lamps and fog lamps

Accessing the lamps via the wheel well



- 1 Turn signal
- 2 Parking/roadside parking/fog lamps

Replacing a turn signal bulb

21 watt bulb, PY 21 W

1. Turn in the wheel.

2. Remove cover 1.
To do so, turn the cover counterclockwise.
3. Remove the inside cover.
To do so, turn the cover counterclockwise.

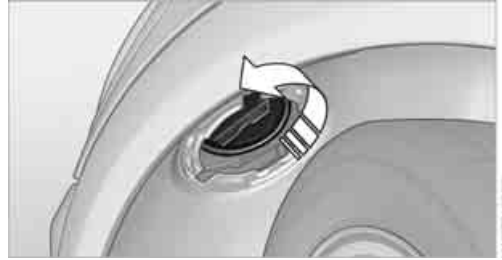

4. Screw out the bulb counterclockwise.

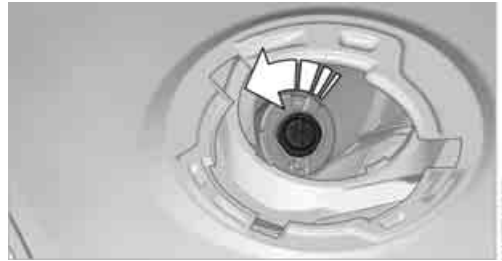

5. To insert the new bulb and replace the covers, proceed in reverse order.

Replacing a parking/roadside parking lamp bulb

5 watt bulb, W 5 W

1. Turn in the wheel.
2. Remove cover 2.
To do so, turn the cover counterclockwise.
3. Screw out the upper bulb counterclockwise.

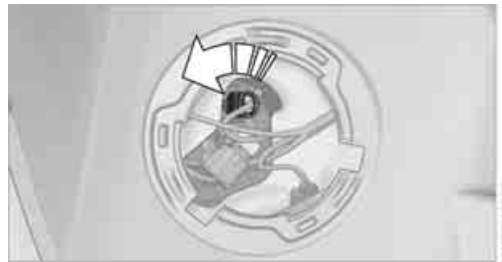

4. To insert the new bulb and replace the cover, proceed in reverse order.

Replacing a fog lamp bulb

H8 bulb, 35 watts

1. Turn in the wheel.
2. Remove cover **2**.
To do so, turn the cover counterclockwise.
3. Screw out the lower bulb counterclockwise.



4. To insert the new bulb and replace the cover, proceed in reverse order.

Side turn signal indicators

5 watt bulb, W 5 W

1. Push the lamp with the ventilation grate forward and remove.

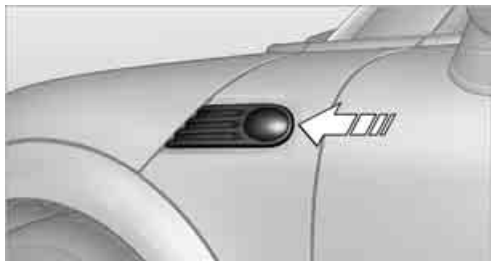

2. Screw out the bulb holder counterclockwise.
3. Pull out and replace the bulb.
4. To insert the new bulb and replace the cover, proceed in reverse order.

Tail lamps

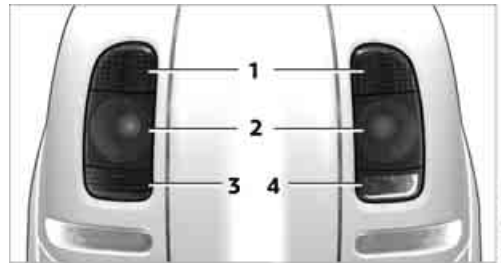

- 1 Brake lamp/tail lamp
21 watt/5 watt bulb, W 5 W
- 2 Turn signal lamp
21 watt bulb, P 21 W
- 3 Rear fog lamp* P 21 W
- 4 Backup lamp
21 watt bulb, P 21 W

Remove the cover from the sidewall of the cargo bay.

Changing

1. Using the screwdriver from the onboard vehicle tool kit, remove the screw at the top.



2. Swing out the tail lamp and remove it toward the top.

3. Pull off the cable connector 1, unlock the bulb holder, arrow 2, and remove it, arrow 3.

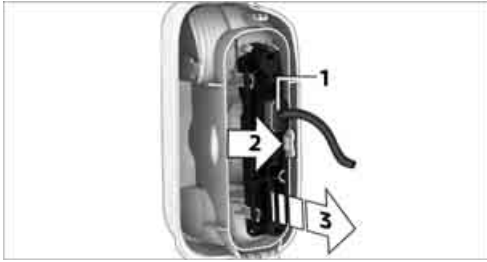

4. Screw out the respective bulb counterclockwise.
5. To insert the new bulb and reinstall the tail lamp, proceed in reverse order.

Rear fog lamp*

21 watt bulb, P 21 W

- ▷ The rear fog lamp is located in the left tail lamp, refer to Tail lamps page 179. ◀

License plate lamps

5 watt bulb, C 5 W

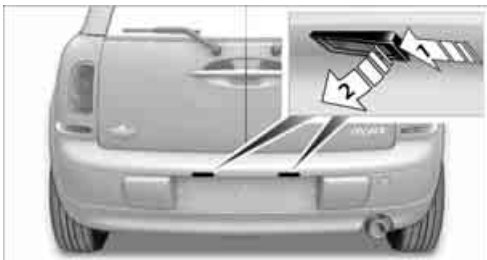

1. Using a screwdriver, push the lamp to the left in the tab of the lamp housing, arrow 1.
2. Remove the lamp, arrow 2.
3. Replace the bulb.
4. Insert the lamp.

Center brake lamp

This lamp uses LED technology for operation. In the event of a malfunction, contact your MINI dealer or a workshop that has specially trained

personnel working in accordance with the specifications of your MINI manufacturer.

REPAIRING A FLAT TIRE

- ▷ Safety measures in the event of a breakdown:

Park the vehicle as far as possible from moving traffic and switch on the hazard warning flashers.

Turn the steering wheel until the front wheels are in the straight-ahead position and engage the steering wheel lock. Engage the parking brake and shift into 1st or reverse gear or place the selector lever in position P.

All passengers should be outside the vehicle and in a safe place, e.g. behind a guardrail.

Erect a warning triangle or warning flasher at the appropriate distance if necessary. Comply with all safety guidelines and regulations. ◀

In the event of a flat tire, different procedures should be followed depending on the equipment included in your vehicle:

- ▷ MINI Mobility System, refer to the following section
- ▷ Run-flat tires, page 165
- ▷ Tire change with space-saver spare tire, page 183

MINI Mobility System with onboard vehicle tool kit and tire change set*

Preparations

Use of the MINI Mobility System may be ineffective if the tire puncture measures approx. 1/8 / 4 mm or more. Contact the nearest MINI dealer if the tire cannot be made drivable with the Mobility System.

Do not remove foreign bodies which have penetrated the tire if possible.

- ▷ Follow the instructions on using the Mobility System found on the compressor and the sealant bottle. ◀

Remove the adhesive label for the speed limit from the sealant bottle and affix it to the steering wheel.

The Mobility System with tire change set and onboard vehicle tool kit is located under the floor mat or the level load floor in the cargo bay.



- 1 Compressor
- 2 Wheel stud wrench*
- 3 Vehicle jack*
- 4 Torx insert bit for screwdriver
- 5 Flat screwdriver/Phillips screwdriver, towing eyelet
- 6 Extractor hook
- 7 Sealant bottle

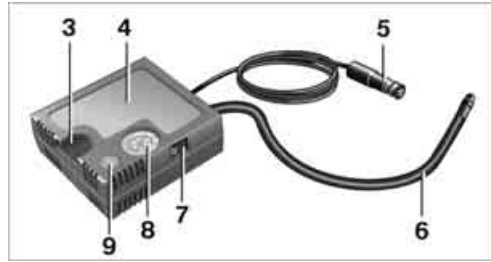

- 3 Holder for the sealant bottle
- 4 Compressor
- 5 Plug and cable for the socket in the vehicle interior, page 92
- 6 Connection hose to connect the compressor and sealant bottle or the compressor and wheel
- 7 On/off switch
- 8 Pressure gauge for indicating the tire inflation pressure
- 9 Release button for reducing the tire inflation pressure

Connector, cable and connection hose are stored in the compressor housing.

Sealant and compressor



- 1 Sealant bottle and adhesive label with speed limit
 - 2 Filling hose
-  Note the use-by date on the sealant bottle. ◀

Using the Mobility System

To repair a tire puncture with the Mobility System, proceed as follows:

- ▷ Filling the tire with sealant
- ▷ Distribute the sealant
- ▷ Correct the tire inflation pressure

Filling the tire with sealant

 Proceed in the specified order; otherwise, sealant may emerge under high pressure. ◀

1. Shake the sealant bottle.
2. Pull the connection hose 9 out of the compressor housing fully and screw it onto the connector of the sealant bottle. Make sure that the hose is not kinked.
3. Insert the sealant bottle on the compressor housing in an upright position.

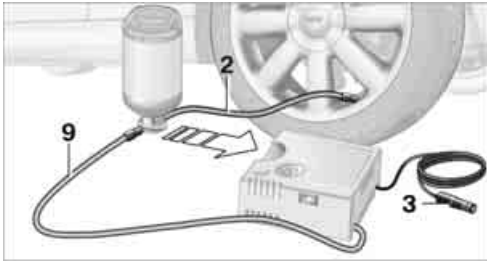

4. Unscrew the dust cap from the valve of the defective wheel and screw the filling hose **2** of the sealant bottle onto the valve.
5. Ensure that the compressor is switched off.
6. Insert the plug **3** into the lighter socket/ power socket in the vehicle interior, page **92**.
7. With the engine running:
Switch on the compressor and let it run for approx. 3 to 8 minutes to fill the tire with sealant and achieve a tire inflation pressure of approx. 26 psi/180 kPa.

▶ When filling the tire with sealant, the inflation pressure can briefly rise to approx. 73 psi/500 kPa. Do not switch off the compressor during this phase. ◀

⚠ Do not run the compressor for longer than 10 minutes; otherwise, the device will overheat and possibly be damaged. ◀

8. Switch off the compressor.

If an air pressure of 26 psi/180 kPa is not reached:

1. Unscrew the filling hose **2** from the wheel and drive the vehicle forward and backward approx. 33 ft/10 m to distribute the liquid sealant in the tire evenly.
2. Inflate the tire again with the compressor.

▶ If an inflation pressure of 26 psi/180 kPa still cannot be reached, the tire is too heavily damaged. Please contact the nearest MINI dealer. ◀

Stowing Mobility System

1. Unscrew filler hose **2** of the sealant bottle from the wheel.
2. Unscrew connecting hose of the compressor **9** from the sealant bottle.
3. Connect the filler hose **2** of the sealant bottle to the unoccupied connection on the sealant bottle.
This prevents the rest of the sealant from escaping from the bottle.
4. Wrap the empty sealant bottle in suitable material to avoid dirtying the cargo bay.
5. Stow Mobility System back in the vehicle.

Distributing the sealant

Immediately drive approx. 3 mls/5 km to evenly distribute the sealant.

▶ Do not exceed speeds of 50 mph/ 80 km/h.

If possible, do not drop below 10 mph/ 20 km/h. ◀

Correcting the tire inflation pressure

1. After driving approx. 3 mls/5 km or ten minutes, stop at a suitable location.
2. Screw the connection hose **2** of the compressor directly onto the tire valve.
3. Insert the plug **3** into the power socket in the vehicle interior.

4. Correct the inflation pressure to 26 psi/ 180 kPa. With the engine running:

▶ To increase the inflation pressure: switch on the compressor. To check the current inflation pressure, switch off the compressor.

⚠ Do not run the compressor for longer than 10 minutes; otherwise, the device will overheat and possibly be damaged. ◀

▶ To decrease the inflation pressure: press the release button **5**.

▶ If the tire cannot maintain the inflation pressure, drive the vehicle again, refer to Distributing the sealant. Then repeat steps 1 to 4.

If an inflation pressure of 26 psi/180 kPa still cannot be reached, the tire is too heavily damaged. Contact the nearest MINI dealer. ◀

Driving on

 Do not exceed the permitted maximum speed of 50 mph/80 km/h; doing so may result in an accident. ◀

Replace the defective tire as soon as possible and have the new wheel/tire assembly balanced.

Have the Mobility System refilled.

CHANGING WHEELS

Space-saver spare tire*

To change a space-saver spare tire, proceed as follows:

- ▷ Remove the space-saver spare tire, page 183
- ▷ Prepare for tire change, page 184
- ▷ Jack up vehicle, page 184
- ▷ Mount space-saver spare tire, page 184
- ▷ Tighten lug bolts, page 184
- ▷ Drive with space-saver spare tire, page 183

Tire change set for a space-saver spare tire*

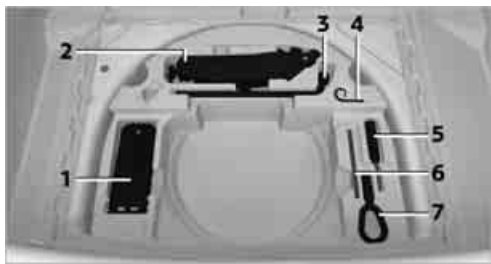

In vehicles with the space-saver spare tire, the tire change set with the onboard vehicle tool kit is located beneath the floor mat or level load floor in the cargo bay.

- 1 Folding chock and cover for defective wheel
- 2 Vehicle jack

- 3 Wheel stud wrench
- 4 Extractor hook*
- 5 Flat screwdriver/Phillips screwdriver
- 6 Torx insert bit for screwdriver
- 7 Towing eyelet

The onboard vehicle tool kit includes a pouch with a plastic bag in which you can place the damaged wheel.

Removing the space-saver spare tire

The space-saver spare tire is located under the tire change set in the cargo bay.

- 1. Fold up the floor mat.
- 2. Unscrew the nut, arrow, and remove the space-saver spare tire.



Driving with the space-saver spare tire

 Drive cautiously and do not exceed a speed of 50 mph/80 km/h. Changes may occur in vehicle handling such as lower track stability during braking, longer braking distances and changes in self-steering properties when close to the handling limit. These properties are more noticeable with winter tires. ◀

 Only one space-saver spare tire may be mounted at one time. Mount a wheel and tire of the original size as soon as possible, to avoid any safety risks. ◀

 Check the tire inflation pressure at the earliest opportunity and correct it if necessary. Replace the defective tire as soon as possible and have the new wheel/tire assembly balanced. ◀

Preparing for a tire change

 Observe the safety precautions regarding flat tires on page 180. ◀

 Additional safety measures when changing tires:

Only change the tire when parked on a surface that is level, firm and not slippery.

The vehicle or the jack could slip sideways on soft or slippery support surfaces, such as snow, ice, flagstones, etc.

Do not use a wooden block or similar object as a support base for the jack, as this would prevent it from extending to its full support height and reduce its load-carrying capacity.

Do not lie under the vehicle or start the engine when the vehicle is supported by the jack; otherwise, there is a risk of fatal injury. ◀

1. Place the foldable chock* behind the front wheel on the other side of the vehicle or in front of the wheel if the vehicle is on an incline. If the wheel is changed on a surface with a more severe slope, take additional precautions to secure the vehicle from rolling.
2. Uncover the lug bolts if necessary.
3. Loosen the lug bolts by a half turn.

Jacking up the vehicle

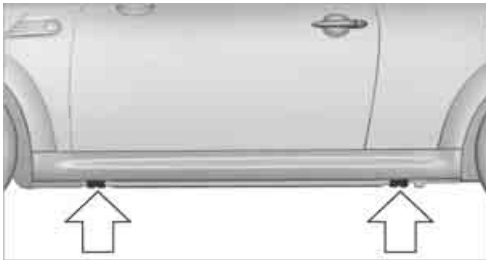

 The vehicle jack is designed for changing wheels only. Do not attempt to raise another vehicle model with it or to raise any load of any kind. To do so could cause accidents and personal injury. ◀

1. Place the jack at the jacking point closest to the wheel.

The jack base must be perpendicular to the surface beneath the jacking point.



2. During jacking up, insert the jack head in the square recess of the jacking point.
3. Jack the vehicle up until the wheel you are changing is raised off the ground.

Mounting the space-saver spare tire

1. Unscrew the lug bolts and remove the wheel.
2. Remove accumulations of mud or dirt from the mounting surfaces of the wheel and hub. Clean the lug bolts.
3. Lift the new wheel into place.
4. Screw at least two lug bolts finger-tight into opposite bolt holes.
5. Screw in the remaining bolts.
6. Tighten all the lug bolts firmly in a diagonal pattern.
7. Lower the vehicle.
8. Remove the jack.

Tightening the lug bolts

Tighten the lug bolts in a diagonal pattern.

 Immediately have the wheels checked with a calibrated torque wrench to ensure that the lug bolts are firmly seated. Otherwise, incorrectly tightened lug bolts can present a safety hazard. ◀

Tightening torque: 103.3 lb ft or 140 Nm.

Replace the defective tire as soon as possible and have the new wheel/tire assembly balanced.

VEHICLE BATTERY

Maintenance

The battery is 100% maintenance-free, the electrolyte will last for the life of the battery when the vehicle is operated in a temperate climate.

Battery replacement

 Only use vehicle batteries that have been approved for your vehicle by the manufacturer; otherwise, the vehicle could be damaged and systems or functions may not be fully available. ◀

After a battery replacement, have the battery registered on the vehicle by your dealer to ensure that all comfort functions are fully available.

Charging the battery

Only charge the battery in the vehicle when the engine is off. Connections, refer to Jump-starting on page 186.

Disposal

 After replacing old batteries, return the used batteries to your MINI dealer or to a recycling point. Maintain the battery in an upright position for transport and storage. Always secure the battery against tipping over during transport. ◀

Power failure

After a temporary power loss, some equipment may not be fully functional and may require initialization. Individual settings are also lost and must be reprogrammed:

- ▷ Time and date
These values must be updated, page 63.
- ▷ Radio
In some cases, stations may have to be stored again, page 137.
- ▷ Navigation system
Operability must be waited for, page 106.

- ▷ Glass sunroof*, electric
It may only be possible to raise the sunroof, if applicable. The system must be initialized. Contact your nearest MINI dealer.

FUSES

 Do not attempt to repair a blown fuse or replace it with a fuse of a different color or Ampere rating. To do this could cause a fire in the vehicle resulting from a circuit overload. Have the fuse changed only by a MINI dealer or a workshop that has specially trained personnel working in accordance with the specifications of the MINI manufacturer. ◀

A fuse allocation diagram is located on the inside of the fuse box cover panels.

In the engine compartment



Opening the cover

Press the latch. ◀

In the vehicle interior

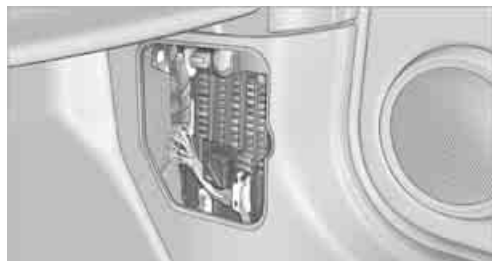

On the right side of the footwell.

Opening the cover

Press out at the recess.

GIVING AND RECEIVING ASSISTANCE

ROADSIDE ASSISTANCE

Roadside Assistance is available by phone 24 hours a day in many countries. You can receive assistance there in the event of an emergency.

Phone numbers for Roadside Assistance are listed in the Contact brochure.

FIRST AID POUCH*

Some of the articles contained in the first aid pouch have a limited service life. Therefore, check the expiration dates of the contents regularly and replace any items in good time, if necessary.



The first aid pouch is located on the cargo bay floor by the left side trim panel or under the level load floor.

WARNING TRIANGLE*

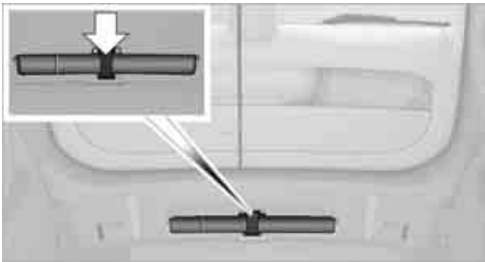

In the cargo bay under the loading sill. Open the center lock to take it out.

JUMP-STARTING

If the car's own battery is flat, your MINI's engine can be started by connecting two jumper cables to another vehicle's battery. You can also use the same method to help start another vehicle. Only use jumper cables with fully-insulated clamp handles.

! Do not touch any electrically live parts when the engine is running, or a fatal accident may occur. Carefully adhere to the following sequence, both to prevent damage to one or both vehicles, and to guard against possible personal injuries. ◀

Preparation

1. Check whether the battery of the other vehicle has a voltage of 12 volts and approximately the same capacitance in Ah. This information can be found on the battery.
2. Switch off the engine of the support vehicle.
3. Switch off any consumers in both vehicles.

! There must not be any contact between the bodies of the two vehicles; otherwise, there is a danger of shorting. ◀

Connecting jumper cables

! Connect the jumper cables in the correct order, so that no sparks which could cause injury occur. ◀

1. Open the battery cover in the engine compartment to access the positive terminal of your MINI.

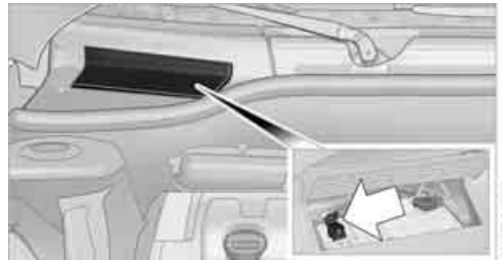

2. Release the tabs of the positive terminal cover* on the left and right, arrows 1, and lift the cover to open, arrow 2.

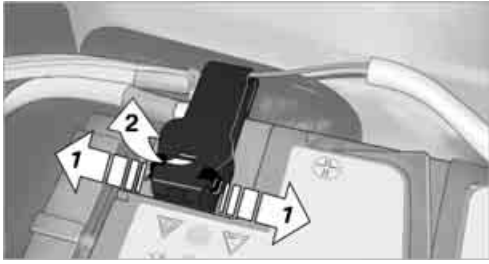

3. Attach one terminal clamp of the plus/+ jumper cable to the positive terminal of the battery or to a starting-aid terminal of the vehicle providing assistance.
4. Attach the second terminal clamp of the plus/+ jumper cable to the positive terminal of the battery or a starting-aid terminal of the vehicle to be started.
5. Attach one terminal clamp of the minus/- jumper cable to the negative terminal of the battery or to an engine or body ground of the assisting vehicle.

Body ground in MINI:

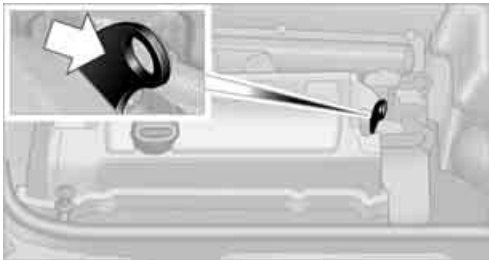

6. Attach the second terminal clamp of the minus/- jumper cable to the negative terminal of the battery or to the engine or body ground of the vehicle to be started.

Starting the engine

1. Start the engine of the donor vehicle and allow it to run for a few minutes at slightly increased idle speed.
2. Start the engine of the other vehicle in the usual manner.

If the first start attempt is not successful, wait a few minutes before another attempt in order to allow the discharged battery to recharge.

3. Let the engines run for a few minutes.
4. Disconnect the jumper cables by reversing the above connecting sequence.

If necessary, have the battery checked and recharged.

 Never use spray fluids to start the engine. ◀

TOW-STARTING, TOWING AWAY

 Observe the applicable laws and regulations for tow-starting and towing vehicles. ◀

 Do not transport any passengers other than the driver in a vehicle that is being towed. ◀

Using a tow fitting

The screw-in tow fitting must always be carried in the car. It can be screwed in at the front or rear of the MINI.

It is stored in the onboard vehicle tool kit in the cargo bay underneath the cover on the right-hand side, page 176.

 Use only the tow fitting provided with the vehicle and screw it all the way in. Use the tow fitting for towing on paved roads only. Avoid lateral loading of the tow fitting, e.g. do not lift the vehicle by the tow fitting. Otherwise, the tow fitting and the vehicle could be damaged. ◀

Access to screw thread

Push out the cover of the towing eye out of the recess in the bumper.

Front

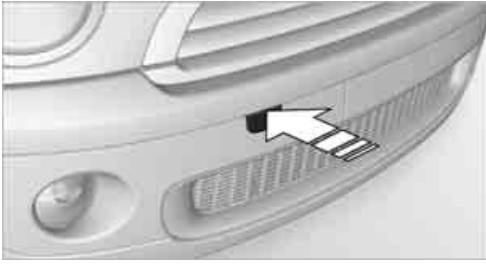

Rear

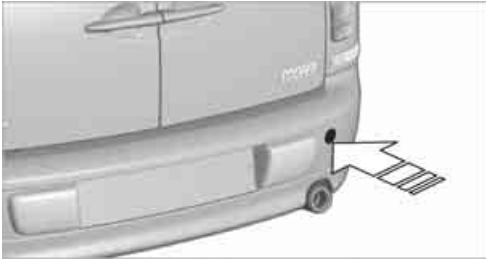

Being towed

! Make sure that the ignition is switched on, refer to page 46; otherwise, the low beams, tail lamps, turn signal indicators and windshield wipers may be unavailable. Do not tow the vehicle with just the rear axle raised, as this would allow the steering to turn. ◀

There is no power assist while the engine is off. Thus, braking and steering will require increased effort.

Switch on the hazard warning flashers, depending on local regulations.

Manual transmission

Gearshift lever in neutral position.

Automatic transmission

! Tow vehicles with automatic transmission only with a tow truck or with the front wheels lifted; otherwise, the transmission can be damaged. ◀

Towing with a tow bar

! The towing vehicle must not be lighter than the towed vehicle; otherwise, it may be impossible to maintain control. ◀

The tow fittings used should be on the same side on both vehicles. Should it prove impossible to avoid mounting the tow bar at an angle, please observe the following:

- ▷ Clearance and maneuvering capability will be sharply limited during cornering.
- ▷ The tow bar will generate lateral forces if it is attached offset.

! Attach the tow bar to the tow fittings only, as attaching it to other parts of the vehicle could result in damage. ◀

Towing with a tow rope

When starting off in the towing vehicle, make sure that the tow rope is taut.

! To avoid jerking and the associated stresses on vehicle components when towing, always use nylon ropes or nylon straps. Attach the tow rope to the tow fittings only, as attaching it to other parts of the vehicle could result in damage. ◀

Towing with a tow truck

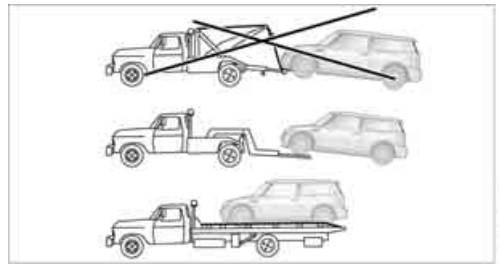

Have the MINI Clubman transported with a tow truck with a so-called lift bar or on a flat bed.

! Do not lift the vehicle by a tow fitting or body and chassis parts; otherwise, damage may result. ◀

Tow-starting

Avoid tow-starting the vehicle whenever possible; instead, jump-start the engine, page 186. Vehicles with a catalytic converter should only be tow-started when the engine is cold, vehicles with an automatic transmission cannot be tow-started at all.

1. Switch on hazard warning flashers, comply with local regulations.
2. Switch on the ignition, page 46.
3. Shift into 3rd gear.
4. Have the vehicle tow-started with the clutch completely depressed and then slowly release the clutch. After the engine starts, immediately depress the clutch completely again.
5. Stop at a suitable location, remove the tow bar or rope and switch off the hazard warning flashers.
6. Have the vehicle checked.

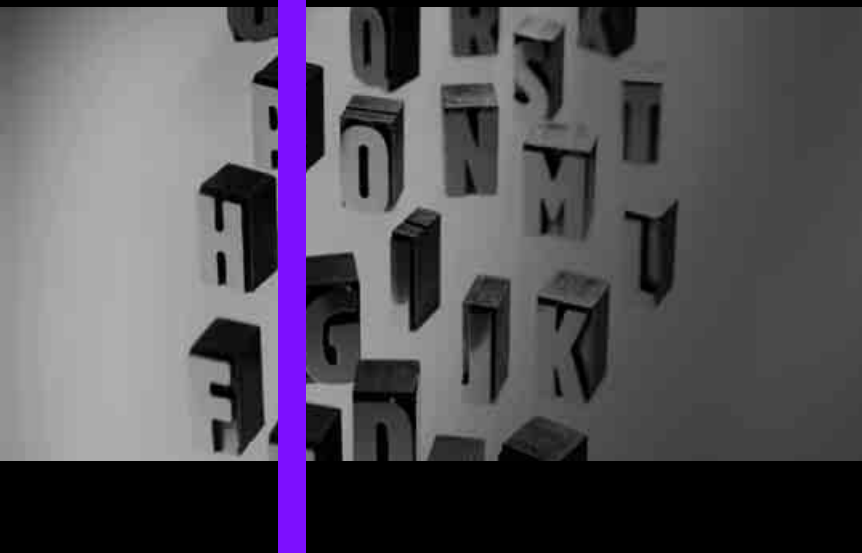

AT A GLANCE

CONTROLS

DRIVING TIPS

NAVIGATION

ENTERTAINMENT

MOBILITY

REFERENCE

TECHNICAL DATA

In the technical data, only the values that differ from the Cooper S are shown for the John Cooper Works.

ENGINE DATA

		Cooper	Cooper S	John Cooper Works
Displacement	cu in/ cm ³	97.5/ 1,598	97.5/ 1,598	97.5/ 1,598
Number of cylinders		4	4	4
Maximum power output	hp	118	172	208
At engine speed	rpm	6,000	5,500	6,000
Maximum torque with overboost	lb ft/ Nm	114/155 –	177/240 192/260	192/260 207/280
At engine speed with overboost	rpm	4,250 –	1,600–5,000 1,700–4,500	1,850–5,600 2,000–5,100
Overboost briefly raises the maximum torque at high rates of acceleration, e.g. when passing.				

DIMENSIONS

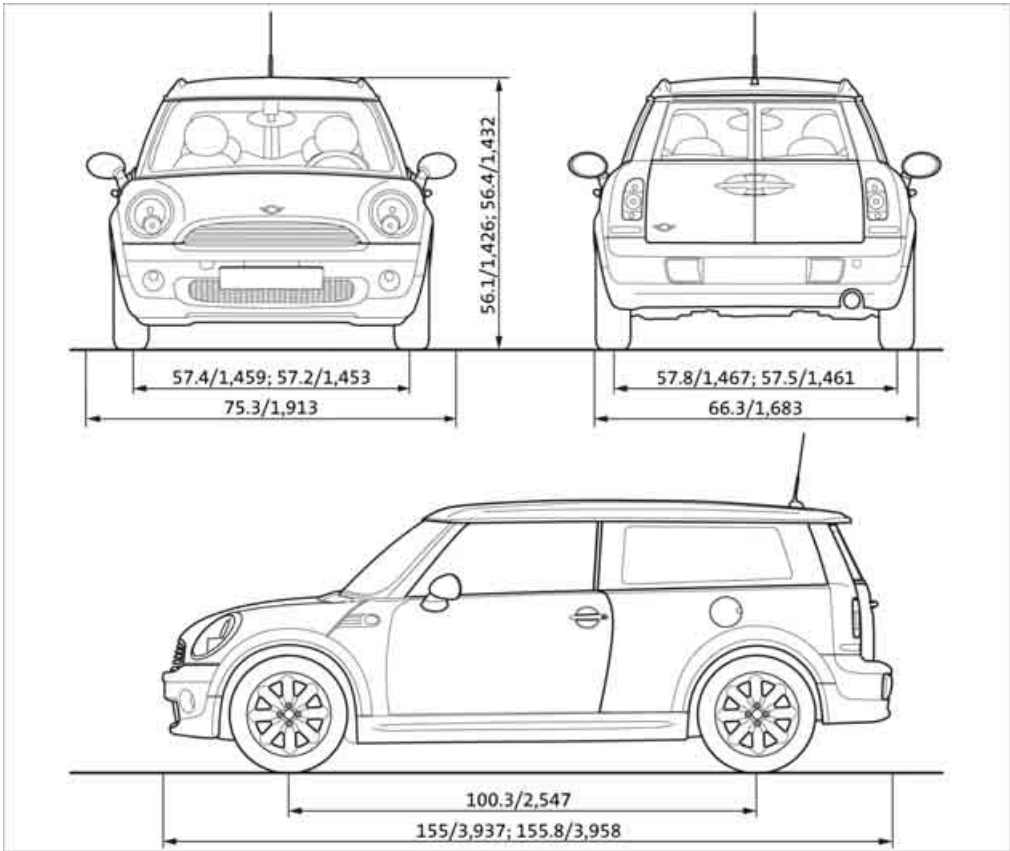

All dimensions in inches/mm. Minimum turning radius \varnothing : 36 ft in/11.0 m.
Information after the semicolon: different values for MINI Cooper S.

AT A GLANCE

CONTROLS

DRIVING TIPS

NAVIGATION

ENTERTAINMENT

MOBILITY

REFERENCE

WEIGHTS

		Cooper	Cooper S	John Cooper Works
Curb weight, ready for travel, with all optional extras				
▷ Manual transmission	lbs/kg	2,723/1,235	2,855/1,295	2,888/1,310
▷ Automatic transmission	lbs/kg	2,800/1,270	2,900/1,315	–
Approved gross weight				
▷ Manual transmission	lbs/kg	3,539/1,605	3,671/1,665	3,704/1,680
▷ Automatic transmission	lbs/kg	3,616/1,640	3,715/1,685	–
Approved front axle load				
▷ Manual transmission	lbs/kg	1,830/830	1,918/870	1,962/875
▷ Automatic transmission	lbs/kg	1,907/865	1,962/890	–
Approved rear axle load	lbs/kg	1,830/830	1,841/835	1,863/845
Approved roof load capacity	lbs/kg	165/75	165/75	165/75
Cargo bay capacity	cu ft/l	9.2 - 32.8/ 260 - 930	9.2 - 32.8/ 260 - 930	9.2 - 32.8/ 260 - 930

Never exceed either the approved axle loads or the gross vehicle weight.

CAPACITIES

	US gal/US quarts	liters	Notes
Fuel tank	13.2/–	approx. 50	Fuel grade: page 157
including reserve of	2.1/–	approx. 8	
Window washer system incl. headlamp washer system	–/4.8	approx. 4.5	For more details: page 52

SHORT COMMANDS FOR THE VOICE ACTIVATION SYSTEM*

With short commands you can carry out certain functions directly, regardless of which menu

item is selected. Here are the important short commands for the voice activation system.

Communication

Function	Command
For additional information, refer to the separate Owner's Manual:	
To select phone	›Phone‹
To dial phone number	›Dial number‹
To display phone book	›A to Z‹
To select from phone book	›Call ...‹ or ›Dial name‹
To display "Top 8"	›Top 8‹
To redial	›Redial‹
To display "Received calls"	›Received calls‹
To display "Missed calls"	›Missed calls‹
To display "Bluetooth"	›Bluetooth‹
To select "MINI Contact"	›MINI Contact‹
To select "MINI Contact Numbers"	›MINI Contact numbers‹
To select "Nearest MINI dealer"	›Nearest MINI dealer‹

Navigation

Function	Command
To select navigation 114	›Navigation‹
To display current position 127	›Current position‹
To select "Enter address" 108	›Enter address‹
To select "New destination" 108	›New destination‹

Function	Command
To display "Input map" 113	›Input map‹
To display address book 115	›Address book‹
To display destination list 115	›Destination list‹
To switch on destination guidance 120	›Start guidance‹
To switch off destination guidance 120	›Stop guidance‹
To display route criteria 118	›Route preference‹
To switch on voice instructions 123	›Navigation info on‹
To switch off voice instructions 123	›Navigation info off‹
To repeat voice instructions 123	›Repeat navigation info‹
To display arrow view 121	›Arrow display‹
To display map view 121	›Map‹, ›Map facing north‹, ›Map direction of travel‹ or ›Perspective‹
To select route 118	›Route‹
To select "New route" 124	›New route‹
To change scale 122	›Scale ... miles‹ or ›Scale ... feet‹
To display towns/cities and streets along the route 123	›Route list‹

Onboard info

Function	Command
To select "Car Data" 57	›Car data‹
To display computer 57	›Onboard info‹
To display trip computer 58	›Trip computer‹
To select speed limit 67	›Limit‹

Function	Command
To activate speed limit 67	›Limit on‹
To deactivate speed limit 67	›Limit off‹
To select stopwatch 68	›Stopwatch‹

Entertainment

Function	Command
Tone control 133	›Audio‹
To switch on radio 135	›Radio on‹, ›FM on‹ or ›AM on‹
To select "FM" 135	›FM menu‹
To select "AM" 135	›AM menu‹
To select "All stations" 135	›FM all stations‹
To select radio station 135	›Station ...‹ (e.g. ›Station WNYC‹ or ›Choose station‹
To select "Presets" 135	›FM presets‹ or ›AM presets‹
To select preset radio station 135	›Preset ...‹ e.g. ›Preset 1‹
To select "Manual" 136	›FM manual‹ or ›AM manual‹ or ›Choose frequency‹ or ›Frequency ... Megahertz‹
To select strongest radio station 136	›AM Autostore‹
To select "SAT" 140	›SAT radio menu‹
To switch on satellite radio 140	›SAT radio‹
To select "Presets" of the satellite radio 141	›SAT radio presets‹
To select "All channels" of the satellite radio 140	›SAT radio all channels‹
To select "Categories" of the satellite radio 140	›SAT radio categories‹
To select CD player 143	›CD menu‹

Function	Command
To switch on CD player 143	›CD‹
To select CD changer 143	›CD changer menu‹
To switch on CD changer 143	›CD changer‹
To select CD 143	›CD 1...6‹
To select track 144	›CD track ...‹
To select CD and track 144	›CD 1...6 track ...‹
To start sound output for external audio device 149	›Audio Aux‹

Setup

Function	Command
To select setup	›Settings menu‹
"Display off" 20	›Display off‹
To select "Info sources"	›Info sources‹
To select "Settings"	›Settings‹
To select "Door locks" 27 , 30	›Door locks‹
To select "Lighting" 50	›Lighting‹
To select "Service requirements" 61	›Service requirements‹
To select "Service" 61	›Service‹
To display "Check Control messages" 65	›Check Control messages‹
To activate speed limit 67	›Limit on‹
To deactivate speed limit 67	›Limit off‹
To set brightness of Control Display 69	›Brightness‹
To select "Units" 55	›Units‹
To select "Language" 68 , 123	›Languages‹
To select "Time" 63	›Time‹
To select "Date" 64	›Date‹

Function	Command
To select "PDC" 70	›PDC‹
To select "FTM" 74	›FTM‹
To display "Bluetooth"	›Bluetooth‹

EVERYTHING FROM A TO Z

INDEX

"..." Identifies Control Display texts used to select individual functions and tells you where to find them.

A

Accessories, refer to Your individual vehicle 4

Acknowledgment signals for locking/unlocking vehicle 28

Activated-charcoal filter for automatic climate control 87

"Add to destination list" 111

Additives

– coolant 169

– engine oil 169

Address for navigation

– deleting 117

– entering 108, 111, 116

– selecting 116

– storing 116

– storing current position 116

Adjusting temperature inside the car, refer to Automatic climate control 86

Adjusting the sound during audio playback, refer to Tone control 133

Air conditioning mode

– automatic climate control 86

– ventilation 87

Air distribution

– automatic 86

Air flow rate 86

– automatic climate control 86

Air pressure, checking, refer to Tire inflation pressure 158

Air recirculation, refer to

Recirculated-air mode 86

Air supply

– automatic climate control 86

– ventilation 87

Air vents 85

Airbags 79

– sitting safely 37

– warning lamp 80

Airing, refer to Ventilation 87

AKI, refer to Fuel grade 157

Alarm system 31

"All channels" 141

All-season tires, refer to Winter tires 166

"AM", waveband 132

Ambient air, refer to

Recirculated-air mode 86

Ambient lighting 84

Antenna, care 172

Antifreeze

– coolant 169

– washer fluid 52

Antilock Brake System ABS 71

Anti-theft alarm system, refer to Alarm system 31

Anti-theft system 27

Approved axle loads, refer to Weights 194

Approved engine oils 169

Approved gross vehicle weight, refer to Weights 194

Armrest, refer to Center armrest 90

Arrival time

– computer 57

– destination guidance 120

"Arrow display" in Navigation 121

Ashtray 91

Assistant systems, refer to

– Dynamic Stability Control DSC 71

Audio 132

– controls 132

– switching on/off 132

– tone control 133

– volume 133

Audio device, external 90

AUTO program for automatic climate control 86

Automatic

– air distribution 86

– air flow rate 86

– cruise control 53

– headlamp control 81

– storing of stations 136

Automatic climate control 85

– automatic air distribution 86

Automatic station search 136

Automatic transmission with Steptronic 48

– interlock 48

– overriding selector lever lock 50

– shiftlock 48

– sport program 49

"Autostore"

– on the radio 137

"AUX" 149, 151

– AUX-IN port 149

– USB audio interface 150

AUX-IN port 149

AUX-IN, refer to External audio device 90

Average fuel consumption 56

– setting the units 60

Average speed 57

"Avoid ferries" in

Navigation 118

"Avoid highways" in

Navigation 118

Avoid highways in navigation **118**
"Avoid tollroads" in Navigation **118**
Axle loads, refer to Weights **194**

B

Background lighting, refer to Ambient lighting **84**
Backrests, refer to Seats **37**
Backup lamps
– replacing bulb **179**
Balance, tone control **133**
Band-aids, refer to First aid pouch **186**
Bar, refer to Tow-starting, towing away **188**
Bass sounds, refer to Tone control **133**
Bass sounds, refer to Treble and bass **133**
Bass, tone control **133**
Battery **185**
– charging **185**
– disposal **34, 185**
– jump-starting **186**
– temporary power failure **185**
Battery renewal
– remote control **34**
Being towed **188**
Belt tensioner, refer to Safety belts **40**
Belts, refer to Safety belts **40**
Beverage holders, refer to Cupholders **91**
Black ice, refer to Outside temperature warning **55**
Blower, refer to Air flow rate **86**
Bottle holders, refer to Cupholders **91**
Brake Assist **71**
Brake fluid, refer to Service requirements **60**

Brake lamps
– replacing bulbs **179**
Brake pads, breaking in **96**
Brake rotors **97**
– brakes **96**
– breaking in **96**
Brake system **96**
– breaking in **96**
– disc brakes **97**
– MINI Maintenance System **170**
Brakes
– ABS **71**
– breaking in **96**
– MINI Maintenance System **170**
– parking brake **47**
– service requirements **60**
Brakes, refer to Braking safely **97**
Breakdown service, refer to Roadside Assistance **186**
Break-in period **96**
Breaking in the clutch **96**
"Brightness" on the Control Display **69**
Bulb changing, refer to Lamps and bulbs **176**
Button for starting the engine **46**
Buttons on the steering wheel **11**

C

California Proposition 65 warning **5**
Can holders, refer to Cupholders **91**
Capacities **194**
Car battery, refer to Vehicle battery **185**
Car care **172**
"Car Data" **57**
Car key, refer to Keys/remote controls **26**

Car phone
– installation location, refer to Center armrest **90**
– refer to separate Owner's Manual
Car radio, refer to Radio **135**
Car wash, care **172**
Car washes **172**
Care **172**
– car washes **172**
– car-care products **172**
– CD/DVD drives **175**
– external **172**
– high-pressure washers **172**
– internal **174**
– leather **174**
– manual washing **173**
– upholstery and fabrics **174**
– windows **173**
– wiper blades **173**
Cargo area
– capacity **194**
Cargo bay **98**
– Comfort Access **33**
– doors, refer to Splitdoor **31**
– lamp **83**
– opening from outside **31**
– trunk lid, refer to Splitdoor **31**
Cargo bay doors, refer to Splitdoor **31**
Cargo bay, expanding **98**
Cargo bay lamp **83**
Cargo bay partition net, refer to Partition net **99**
Cargo loading **99**
– securing cargo **100**
– stowing cargo **100**
– vehicle **98**
Cargo, securing **100**
Carpets, care **174**
Catalytic converter, refer to Hot exhaust system **96**
"Categories" **141**
"CD" **132, 143**

- CD changer 143
 - controls 132
 - fast forward/reverse 146
 - playing a track 144
 - random order 146
 - repeating a track 145
 - selecting a CD 143
 - selecting a track 144
 - switching on/off 132
 - tone control 133
 - volume 133
- CD player 143
 - controls 132
 - fast forward/reverse 146
 - playing a track 144
 - random order 146
 - repeating a track 145
 - selecting a track 144
 - switching on/off 132
 - tone control 133
 - volume 133
- Center armrest 90
- Center brake lamp 180
- Center console, refer to
 - Around the center console 14
- "Central locking" 28
- Central locking system 27
 - Comfort Access 33
 - from inside 30
 - from outside 27
- Changing bulbs 176
- Changing the language on the
 - Control Display 68
- Changing the measurement units on the
 - Control Display 60
- Changing wheels 183
- Chassis number, refer to
 - Engine compartment 168
- Check Control 65
- "Check Control messages" 67
- Child restraint systems 43
- Child seats 43
- Child-restraint fixing system
 - LATCH 44
- Chrome parts, care 173
- Chrome parts, refer to
 - Care 172
- Cigarette lighter 92
- Cleaning headlamps 52
 - washer fluid 52
- Clock 55
 - 12h/24h mode 64
 - hour signal 64
 - setting time 63
- Closing
 - from inside 30
 - from outside 27
- Clothes hooks 91
- Clubdoor 31
- Cockpit 10
- Cold start, refer to Starting the engine 47
- Comfort Access 33
 - replacing the battery 34
 - what to observe before entering a car wash 34
- Comfort area, refer to Around the center console 14
- Compact disc, refer to
 - CD changer 143
 - CD player 143
- Compartment for remote control, refer to Ignition lock 46
- Computer 56
 - displays on Control Display 57
 - hour signal 64
- Condensation, refer to When the vehicle is parked 97
- Condition Based Service CBS 170
- Configuring settings, refer to Personal Profile 26
- Connecting vacuum cleaner, refer to Connecting electrical appliances 92
- Consumption, refer to Average fuel consumption 56
- Control Display
 - settings 59
 - switching off/on 20
- Control Display, refer to
 - Onboard monitor 16
- Control stick, refer to Onboard monitor 16
- Control unit, refer to Onboard monitor 16
- Controls and displays 10
- Convenient access, refer to Comfort Access 33
- Convenient operation
 - windows 28
- Convenient start, refer to
 - Starting the engine 47
- Coolant 169
 - checking level 169
 - filling 169
- Coolant temperature 56
- Cooling fluid, refer to
 - Coolant 169
- Cooling, maximum 86
- Copyright 2
- Country of destination for navigation 109
- Cross-hairs in navigation 113
- Cruise control
 - indicator lamp 13
- Cruising range 56
- Cupholders 91
- Curb weight, refer to
 - Weights 194
- Current fuel consumption 57
- "Current position" 127
- Current position
 - displaying 127
 - entering 116
 - storing 116

D

- Dashboard instruments, refer to Displays 12
- Dashboard lighting, refer to Instrument lighting 83
- Dashboard, refer to Cockpit 10
- Data 192
 - capacities 194
 - dimensions 193
 - engine 192
 - weights 194
- Data memory 171
- "Date" 65

Date
– setting 64
– setting format 65
"Date format" 65
"Daytime running lamps" 82
Daytime running lights 82
DBC Dynamic Brake Control,
refer to Brake Assist 71
Deactivating front passenger
airbags 79
Deadlocking, refer to
Locking 28
Defect
– door lock 30
– fuel filler flap 156
Defogging windows 87
Defrost position, refer to
Defrosting windows 87
Defrosting windows 87
Defrosting windows and
removing condensation
– automatic climate control 87
Defrosting windshield, refer to
Defrosting windows 87
Destination address
– deleting 117
– entering 108, 111
Destination for navigation
– destination list 115
– entry 108
– home address 117
– manual entry 108, 111
– selecting from address
book 116
– selecting using
information 114
– selecting via map 113
– storing 116
Destination guidance 120
– changing specified route 118
– displaying route 121
– distance and arrival 120
– interrupting 120
– starting 120
– taking detours 124
– terminating/continuing 120
– voice instructions 123
– volume for voice
instructions 123

Destination list for navigation
system 115
Destinations recently driven
to 115
Detour, refer to Driving around
a traffic congestion 127
Differential, breaking in 96
Digital clock 55
Digital radio, refer to HD
Radio 138
Dimensions 193
Dipstick, engine oil 168
Direction instructions, refer to
Voice instructions 123
Directional indicators, refer to
Turn signals 50
Directory for navigation, refer
to Address book 115
Displacement, refer to Engine
data 192
Display lighting, refer to
Instrument lighting 83
"Display off" 20
Display, refer to Onboard
monitor controls 16
Displays 12
– instrument combination 12
– on the Control Display 16
Displays and controls 10
Displays, care 174
Disposal
– of coolant 169
– remote control battery 34
– vehicle battery 185
"Dist. to dest." 58
Distance remaining to service,
refer to Service
requirements 60
Distance warning, refer to Park
Distance Control PDC 70
Door
– rear, refer to Clubdoor 31
Door key, refer to Integrated
key/remote control 26
Door lock 29
Door lock, confirmation
signals 28
"Door locks" 28, 30
Doors, manual operation 30

DOT Quality Grades 163
Double doors, refer to
Splitdoor 31
Drinks holders, refer to
Cupholders 91
Drive-off assistant, refer to Hill
Assist 73
Driving around a traffic
congestion 127
Driving dynamics control, refer
to Sport button 73
Driving lamps, refer to Parking
lamps/low beams 81
Driving notes 96
Driving off on inclines, refer to
Hill Assist 73
Driving route, refer to
Displaying route 121
Driving stability control
systems 71
Driving through water 97
Driving tips, refer to Driving
notes 96
Dry air, refer to Cooling
function 87
DTC Dynamic Traction Control
DTC 72
DVD for navigation 106
Dynamic Brake Control DBC,
refer to Brake Assist 71
Dynamic Stability Control
DSC 71
Dynamic Traction Control 72

E

Eject button, refer to Buttons
on the CD player 132
Electrical malfunction
– door lock 30
– fuel filler flap 156
Electronic brake-force
distribution 71
Electronic Stability Program
ESP, refer to Dynamic
Stability Control DSC 71

- Emergency operation, refer to
 - Manual operation
 - door lock [30](#)
 - fuel filler flap [156](#)
 - transmission lock, automatic transmission [50](#)
- Emergency services, refer to
 - Roadside Assistance [186](#)
- Engine
 - breaking in [96](#)
 - data [192](#)
 - overheated, refer to Coolant temperature [56](#)
 - speed [192](#)
 - starting [47](#)
 - starting, Comfort Access [33](#)
 - switching off [47](#)
- Engine compartment [168](#)
- Engine coolant, refer to
 - Coolant [169](#)
- Engine malfunction
 - indicator lamp [13](#)
- Engine oil
 - adding [169](#)
 - additives, refer to Approved engine oils [169](#)
 - alternative oil types [169](#)
 - approved engine oils [169](#)
 - capacity [169](#)
 - checking level [168](#)
 - dipstick [168](#)
 - intervals between changes, refer to Service requirements [60](#)
 - MINI Maintenance System [170](#)
- Engine oil level, checking [168](#)
- Engine output, refer to Engine data [192](#)
- Engine starting, refer to
 - Starting the engine [47](#)
- Entering address [111](#)
- Entering destination [109](#)
- Entering intersection [110](#)
- Error messages, refer to Check Control [65](#)
- "ESN" [139](#), [140](#), [141](#)
- ESP Electronic Stability Program, refer to Dynamic Stability Control DSC [71](#)
- Exhaust system, refer to Hot exhaust system [96](#)
- Exterior mirrors [41](#)
 - adjusting [41](#)
 - automatic heating [41](#)
 - folding in and out [41](#)
- External audio device [90](#)
- External audio device, refer to AUX-IN port [149](#)
- Eyes
 - for tow-starting and towing away [187](#)
 - for tying down loads [100](#)
- F**
- Fader, tone control [133](#)
- Failure messages, refer to Check Control [65](#)
- Failure of an electrical consumer [185](#)
- Fast forward
 - CD changer [146](#)
 - CD player [146](#)
- "Fast route" in Navigation [118](#)
- Fastening safety belts, refer to Safety belts [40](#)
- Fastest route for navigation [118](#)
- Filter
 - microfilter/activated-charcoal filter for automatic climate control [87](#)
- Fine wood, care [174](#)
- First aid pouch [186](#)
- Fixture for remote control, refer to Ignition lock [46](#)
- Flash when locking/unlocking [28](#)
- Flat tire
 - run-flat tires [165](#)
 - Tire Pressure Monitor TPM [75](#)
- Flat Tire Monitor FTM [73](#)
 - indicating a flat tire [74](#)
 - initializing the system [74](#)
 - snow chains [74](#)
 - system limits [74](#)
- Flat tires, refer to Tire condition [164](#)
- Floor mats, care [174](#)
- Floor plate, refer to Level load floor [99](#)
- "FM", waveband [132](#), [135](#)
- FM, waveband [135](#)
- Fog lamps
 - replacing bulb [178](#), [180](#)
- Folding rear seat backrest [98](#)
- Footbrake, refer to Braking safely [97](#)
- Footwell lamps [83](#)
- For your own safety [5](#)
- Frequency, selecting manually [136](#)
- Front airbags [79](#)
- Front fog lamps [83](#)
 - replacing bulb [178](#)
- Front seat adjustment [37](#)
- Frost on windows, refer to Defrosting windows [87](#)
- "FTM" [76](#)
- FTM, refer to Flat Tire Monitor [73](#)
- Fuel [157](#)
 - gauge [56](#)
 - high-quality brands [157](#)
 - quality [157](#)
 - specifications [157](#)
 - tank capacity [194](#)
- Fuel clock, refer to Fuel gauge [56](#)
- Fuel consumption display
 - average fuel consumption [56](#)
- Fuel display, refer to Fuel gauge [56](#)
- Fuel filler flap [156](#)
 - releasing in the event of electrical malfunction [156](#)
- Fuses [185](#)

G

- Garage door opener, refer to Integrated universal remote control **88**
- Gasoline
 - refer to Average fuel consumption **56**
- Gasoline display, refer to Fuel gauge **56**
- Gasoline, refer to Required fuel **157**
- Gear indicator
 - automatic transmission with Steptronic **48**
- Gear shifting
 - automatic transmission **48**
 - manual transmission **48**
- Gearshift lever
 - automatic transmission with Steptronic **48**
 - manual transmission **48**
- General driving notes **96**
- Glass sunroof, electric **34**
 - convenient operation **28, 29**
 - opening, closing **35**
 - raising **35**
 - remote control **28**
- Glove compartment **89**
- GPS navigation, refer to Navigation system **106**
- Grills **85**
- Gross vehicle weight, refer to Weights **194**

H

- Halogen lamps
 - replacing bulb **177**
- Handbrake, refer to Parking brake **47**
- Hands-free system **14**
- Hazard warning flashers **14**
- "HD radio" **138**
- HD radio, refer to High Definition Radio **138**
- Head airbags **79**
- Head restraints **39**
 - sitting safely **37**

- Headlamp control, automatic **81**
- Headlamp flasher **50**
 - indicator lamp **11, 13**
- Headlamps
 - replacing bulb **177**
- Headlamps, care **173**
- Headlight glass lens **177**
- Heated
 - mirrors **41**
 - rear window **87**
 - seats **40**
- Heating
 - mirrors **41**
 - rear window **87**
 - seats **40**
- Heavy loads, refer to Stowing cargo **100**
- Height adjustment
 - seats **38**
 - steering wheel **41**
- Height, refer to Dimensions **193**
- High beams **82**
 - headlamp flasher **82**
 - indicator lamp **13**
 - replacing bulb **177**
- High Definition Radio, refer to HD Radio **138**
- High water, refer to Driving through water **97**
- Highways, refer to Route criteria **118**
- Hill Assist **73**
- Hills **97**
- Holders for cups **91**
- Home address **117**
 - "Home address" in Navigation **118**
- Homepage **4**
- Hood **167**
- Horn **10**
- Hot exhaust system **96**
- "Hour memo" **64**
- "House number" in destination input **111**
- Hydroplaning **96**

I

- IBOC, refer to HD Radio **138**
- Ice warning **55**
- ID3 tag, refer to Information about the track **144**
- Ignition **46**
 - switched off **46**
 - switched on **46**
- Ignition key position 1, refer to Radio readiness **46**
- Ignition key position 2, refer to Ignition on **46**
- Ignition key, refer to Integrated key/remote control **26**
- Ignition lock **46**
- Imprint **2**
- Indicator and warning lamps **13**
 - Tire Pressure Monitor TPM **77**
- Indicator lighting, refer to Instrument lighting **83**
- Individual settings, refer to Personal Profile **26**
- Inflation pressure monitoring, refer to Tire Pressure Monitor TPM **75**
- Information
 - on another location **114**
 - on country **114**
 - on current position **114**
 - on destination location **114**
- "Information" in Navigation **114**
- "Information on destination" **115**
- Initializing
 - Flat Tire Monitor FTM **74**
 - glass sunroof, electric **35**
- Installation location
 - drive for navigation DVD and audio CD **106**
- Instructions for navigation system, refer to Voice instructions **123**

Instrument cluster, refer to
 Displays [12](#)
 Instrument lighting [83](#)
 Instrument panel, refer to
 Cockpit [10](#)
 Instrument panel, refer to
 Displays [12](#)
 Integrated key [26](#)
 Integrated universal remote
 control [88](#)
 Interesting destination for
 navigation [114](#)
 "Interim time" [68](#)
 Interior lamps [83](#)
 – remote control [28](#)
 Interior rearview mirror [41](#)
 – automatic dimming
 feature [41](#)
 Interlock [48](#)
 Intermittent mode of the
 wipers [51](#)
 Internet page [4](#)

J

Jacking points [184](#)
 Jets, refer to Window washer
 nozzles [52](#)
 Joystick, refer to Onboard
 monitor [16](#)
 Jumping, refer to Jump-
 starting [186](#)
 Jump-starting [186](#)

K

Key Memory, refer to Personal
 Profile [26](#)
 Key, refer to Keys/remote
 controls [26](#)
 Keyless opening and closing,
 refer to Comfort Access [33](#)
 Keyless-Go, refer to Comfort
 Access [33](#)
 Kickdown [49](#)
 – automatic transmission with
 Steptronic [49](#)

Knock control [157](#)

L

Lamps and bulbs, replacing
 bulbs [176](#)
 Lamps, refer to Parking lamps/
 Low beams [81](#)
 "Language" in Navigation [123](#)
 "Languages" in
 Navigation [106](#)
 Lashing eyes, refer to Securing
 cargo [100](#)
 Last destinations, refer to
 Destination list [115](#)
 LATCH child-restraint fixing
 system [44](#)
 Leather care [174](#)
 LEDs light-emitting diodes [177](#)
 Length, refer to
 Dimensions [193](#)
 Level load floor [99](#)
 License plate lamp
 – bulb replacement [180](#)
 Liftgate
 – Comfort Access [33](#)
 Liftgate, refer to Splitdoor [29](#)
 Light switch [81](#)
 Light-alloy wheels, care [173](#)
 Light-emitting diodes
 LEDs [177](#)
 Lighter [92](#)
 – socket [92](#)
 "Lighting" [82](#)
 Lighting
 – lamps and bulbs [176](#)
 – of the instruments [83](#)
 – of vehicle, refer to Lamps [81](#)
 "Limit" [68](#)
 Limit, refer to Speed limit [67](#)
 Load [99](#)
 Load securing equipment,
 refer to Securing cargo [100](#)
 Lock buttons of doors, refer to
 Locking [30](#)

Locking
 – adjusting confirmation
 signal [28](#)
 – from inside [30](#)
 – from outside [28](#)
 – without remote control, refer
 to Comfort Access [33](#)
 Locking and unlocking doors
 – confirmation signals [28](#)
 – from inside [30](#)
 – from outside [27](#)
 Low beams [81](#)
 – automatic [81](#)
 – replacing bulb [177](#)
 Lower back support, refer to
 Lumbar support [38](#)
 Luggage compartment doors,
 refer to Splitdoor [31](#)
 Luggage compartment
 partition net, refer to
 Partition net [99](#)
 Luggage rack, refer to Roof-
 mounted luggage rack [101](#)
 Lumbar support [38](#)

M

M+S tires, refer to Winter
 tires [166](#)
 Maintenance, refer to Service
 Booklet
 Maintenance system [170](#)
 Malfunction warnings, refer to
 Check Control [65](#)
 Manual mode
 – automatic transmission with
 Steptronic [49](#)
 "Manual" mode on the
 radio [136](#)
 Manual operation
 – door lock [30](#)
 – fuel filler flap [156](#)
 – transmission lock, automatic
 transmission [50](#)

Manual transmission [48](#)
Manual washing [173](#)
Map
– changing scale [122](#)
– destination entry [113](#)
"Map direction of travel" [122](#)
"Map facing north" [122](#)
Master key, refer to Integrated key/remote control [26](#)
Maximum cooling [86](#)
Maximum speed
– with winter tires [166](#)
Medical assistance, refer to First aid pouch [186](#)
MENU button [16](#)
Menus, refer to Onboard monitor [16](#)
Microfilter
– for automatic climate control [87](#)
– MINI Maintenance System [170](#)
Microfilter/activated-charcoal filter
– MINI Maintenance System [170](#)
Microphone for telephone [14](#)
MINI Internet page [4](#)
MINI joystick, refer to Onboard monitor [16](#)
MINI Maintenance System [170](#)
Mirror dimming feature [41](#)
Mirrors [41](#)
– exterior mirrors [41](#)
– heating [41](#)
– interior rearview mirror [41](#)
Mobile phone
– installation location, refer to Center armrest [90](#)
– refer to separate Owner's Manual

Mobile phone, installation location, refer to Center armrest [90](#)
Mobile phone, refer to the separate Owner's Manual
Mobility System [180](#)
Modifications, technical, refer to For your own safety [5](#)
Monitor, refer to MINI controls with navigation [16](#)
Monitoring system for tire pressures, refer to Flat Tire Monitor [73](#)
MP3, refer to Compressed audio files [143](#)
Multifunction switch
– refer to Turn signals/headlamp flasher [50](#)
– refer to Wiper system [51](#)
Multifunctional steering wheel, refer to Buttons on the steering wheel [11](#)
Music track
– playback, scan [144](#)
– random order [146](#)
– search [144](#)
Muting TV [132](#)

N

Navigation announcements, refer to Switching voice instructions on/off [123](#)
Navigation drive, location [106](#)
Navigation DVD [106](#)

Navigation system [106](#)
– address book [115](#)
– changing a route [124](#)
– destination entry [108](#)
– destination list [115](#)
– displaying current position [127](#)
– entering a destination manually [108](#), [111](#)
– last destinations [115](#)
– opening [108](#)
– route display [121](#)
– route list [123](#)
– searching for a special destination [114](#)
– selecting destination using information [114](#)
– selecting destination via map [113](#)
– selecting route criteria [118](#)
– starting destination guidance [120](#)
– switching off, refer to Terminating/continuing destination guidance [120](#)
– terminating/continuing destination guidance [120](#)
– voice instructions [123](#)
– volume adjustment [123](#)
"Navigation voice instructions" [106](#)
Neck support, refer to Head restraints [39](#)
Nets, refer to Storage compartments [90](#)
"New address" in Navigation [116](#)
"New destination" [108](#), [113](#)
"New route" [124](#)
New tires [165](#)
North-facing map [121](#)
Nozzles [85](#)
Number of cylinders, refer to Engine data [192](#)
Number of safety belts [37](#)
Nylon rope, refer to Tow rope [188](#)

O

OBD socket, refer to Socket for Onboard Diagnosis [170](#)

Octane ratings, refer to Fuel specifications [157](#)

Odometer [55](#)

Oil consumption [168](#)

Oil level [168](#)

Oil, refer to Engine oil [168](#)

Oil types [169](#)

Old batteries, refer to Disposal [185](#)

"On a new destination" in Navigation [114](#)

"On destination" [114](#)

"On location" [114](#)

"Onboard info" [57](#)

Onboard monitor [16](#)

- adjusting brightness [69](#)
- changing date and time [63](#)
- changing language [68](#)
- confirming selection or entry [19](#)
- displays, menus [16](#)
- menu guidance [17](#)
- operating principles [16](#)
- overview [16](#)
- selecting menu items [19](#)
- status information [20](#)
- symbols [18](#)

Onboard vehicle tool kit [176](#)

Opening and closing

- Comfort Access [33](#)
- from inside [30](#)
- from outside [27](#)
- using the door lock [29](#)
- using the remote control [27](#)

Opening and unlocking

- from inside [30](#)

Opening/closing the splitdoor [31](#)

Orientation menu, refer to Start menu [17](#)

Outlets

- refer to Ventilation [87](#)

Output, refer to Engine data [192](#)

Outside temperature display [55](#)

- change units of measure [60](#)
- in the onboard computer [60](#)

Outside-air mode

- automatic climate control [86](#)

Overheated engine, refer to Coolant temperature [56](#)

P

Paintwork, care [173](#)

Park Distance Control PDC [70](#)

Parking

- vehicle [47](#)

Parking aid, refer to Park Distance Control PDC [70](#)

Parking brake [47](#)

- indicator lamp [13](#)

Parking lamps, replacing bulb [178](#)

Parking lamps/low beams [81](#)

Partition net [99](#)

Parts and accessories, refer to Your individual vehicle [4](#)

"Pathway lighting" [82](#)

Pathway lighting [81](#)

"PDC" [71](#)

Personal Profile [26](#)

"Perspective" [122](#)

Pinch protection system

- windows [36](#)

Plastic parts, care [174](#)

Pollen

- refer to Microfilter/activated-charcoal filter for automatic climate control [87](#)

Position

- displaying [127](#)
- storing [116](#)

Power failure [185](#)

Power windows [35](#)

Power windows, refer to Windows [35](#)

"Presets" on the radio [141](#)

Pressure monitoring of tires, refer to Tire Pressure Monitor TPM [75](#)

Pressure monitoring, tires [73](#)

- Flat Tire Monitor [73](#)

Pressure, tires [158](#)

Protective function, refer to Pinch protection system

- windows [36](#)

Puncture

- Flat Tire Monitor [73](#)

R

Radio

- autostore [136](#)
- controls [132](#)
- HD Radio [138](#)
- sampling stations [136](#)
- satellite radio [140](#)
- select waveband [132](#), [135](#)
- selecting the frequency manually [136](#)
- station search [136](#)
- storing stations [137](#)
- strongest stations [136](#)
- switching on/off [132](#)
- tone control [133](#)
- tuning to station [135](#)
- volume [133](#)

Radio key, refer to Integrated key/remote control [26](#)

Radio position, refer to Radio readiness [46](#)

Radio readiness [46](#)

- switched off [46](#)
- switched on [46](#)

Rain sensor [51](#)

"Random all" during audio playback [146](#)

"Random directory" during audio playback [146](#)

Random play sequence [146](#)

Range, refer to Cruising range [56](#)

Reading lamps [84](#)

Rear door, refer to Clubdoor [31](#)

Rear doors, refer to Splitdoor [31](#)

Rear double doors, refer to Splitdoor [31](#)

Rear fog lamp **83**
– indicator lamp **13**
– replacing bulb **180**
Rear lamps
– bulb replacement **179**
Rear lamps, refer to Tail lamps **179**
Rear seat backrest, folding **98**
Rear seats
– folding the backrests **98**
Rear window defroster **87**
Rearview mirror, refer to Mirrors **41**
Receiving level of mobile phone, refer to Status information **20**
Reception
– radio station **138**
Recirculated-air mode **86**
Recirculation of air, refer to Recirculated-air mode **86**
Reclining seat, refer to Backrest **38**
Recording times, refer to Stopwatch **68**
Refueling **156**
Releasing
– hood **167**
Remote control **26**
– battery renewal **34**
– Comfort Access **33**
– garage door opener **88**
– malfunctions **29, 34**
– service data **170**
– splitdoor **29**
"Repeat directory" during audio playback **146**
"Repeat track" during audio playback **146**
Replacement remote control **26**
Replacing bulbs, refer to Lamps and bulbs **176**
Replacing tires, refer to New wheels and tires **165**
Reporting safety defects **6**
Reserve warning, refer to Fuel gauge **56**

Reservoir for washer systems **52**
"Reset" **74**
"Reset" of tone settings **134**
Reset, refer to Resetting tone settings **134**
"Reset" the stopwatch **68**
Restraint systems
– for children **43**
– refer to Safety belts **40**
Reverse
– CD changer **146**
– CD player **146**
Reverse gear
– automatic transmission with Steptronic **49**
– manual transmission **48**
Road map **121**
Roadside Assistance **186**
Roadside parking lamps **82**
– replacing bulb **178**
Roadworthiness test, refer to Service requirements **60**
Roof load capacity **194**
Roof-mounted luggage rack **101**
Rope, refer to Tow-starting, towing away **188**
Route **118**
– changing **118, 124**
– display **121**
– displaying arrow view **121**
– displaying map view **121**
– displaying town **123**
– list **123**
– selecting **118**
– selecting criteria **118**
– taking detours **124**
Route selection **118**
RSC Run-flat System
– Component, refer to Run-flat tires **165**
Rubber parts, care **173**
Run-flat System Component
– RSC, refer to Run-flat tires **165**

Run-flat tires **165**
– flat tire **74**
– tire inflation pressure **158**
– tire replacement **165**
– winter tires **166**

S

Safety belt
– number **37**
Safety Belt Reminder **40**
Safety belts **40**
– damage **40**
– indicator lamp **40**
– reminder **40**
– sitting safely **37**
Safety belts, care **174**
Safety systems
– airbags **79**
– Antilock Brake System
– ABS **71**
– Dynamic Stability Control
– DSC **71**
– safety belts **40**
Safety tires, refer to Run-flat tires **165**
"SAT" on the radio **132, 140**
Satellite radio **140**
– enabling channel **140**
– selecting channel **140**
– storing channel **140**
Scale for navigation,
– changing **122**
"Scan"
– Briefly play stations on the radio **136**
Scan
– CD changer **144**
– CD player **144**
– radio **136**
"Scan all" during audio playback **145**
"Scan directory" during audio playback **145**
Screen, refer to Onboard monitor controls **16**
Screw thread for tow fitting **187**

- SDARS, refer to Satellite radio **140**
- Seat adjustment
 - mechanical **38**
- Seats **37**
 - adjusting the seats **38**
 - heating **40**
 - sitting safely **37**
- Securing the vehicle
 - from inside **30**
 - from outside **27**
- Select "All stations" on the radio **135**
- "Select as destination" **114**
- "Select current speed" **68**
- Select "Presets" on the radio **135**
- Selecting an audio source **132**
- Selecting menu items **19**
- Selecting the route **118**
- Selection options for navigation **118**
- Selector lever
 - automatic transmission with Steptronic **48**
- Selector lever lock
 - automatic transmission with Steptronic, refer to Shiftlock **48**
 - overriding manually **50**
- Selector lever positions
 - automatic transmission with Steptronic **48**
- "Service" **67**
- Service car, refer to Roadside Assistance **186**
- Service data in the remote control **170**
- Service Interval Display, refer to Condition Based Service CBS **170**
- Service, refer to Roadside Assistance **186**
- Service requirement display, refer to Condition Based Service CBS **170**
- "Service requirements" **61, 62**
- Service requirements **60**
- "Set date" **65**
- Settings
 - clock, 12h/24h mode **64**
 - date format **65**
- Shifting gears
 - automatic transmission with Steptronic **49**
 - manual transmission **48**
- Shiftlock
 - automatic transmission, refer to Changing selector lever positions **48**
- Short commands for the voice activation system **195**
- "Short route" in Navigation **118**
- Shortest route in navigation, refer to Selecting route **118**
- "Show current position" **113**
- "Show destination position" **113**
- Shuffled, refer to Random
 - CD changer **146**
 - CD player **146**
- Side airbags **79**
- Side door, rear, refer to Clubdoor **31**
- Side turn signal indicator
 - replacing bulb **179**
- Side windows, refer to Windows **35**
- Signal horn, refer to Horn **10**
- Sitting safely **37**
 - airbags **37**
 - safety belts **37**
 - with head restraint **37**
- Size, refer to Dimensions **193**
- Sliding/tilt sunroof
 - refer to Glass sunroof, electric **34**
- Slot for remote control **46**
- Smokers' package, refer to Ashtray **92**
- Snap-in adapter, refer to Center armrest storage compartment **90**
- Snow chains **166**
- Socket for Onboard Diagnosis OBD **170**
- Socket, refer to Connecting electrical appliances **92**
- Song search, refer to Playing a track **144**
- Sound output for entertainment on/off **132**
- Space-saver spare tire
 - changing tires **183**
 - inflation pressure **158**
- Spare wheel, refer to Space-saver spare tire **183**
- Speaking, refer to Voice instructions from navigation system **123**
- Special oils, refer to Approved engine oils **169**
- Speed **192**
 - with winter tires **166**
- Speed limit **67**
 - setting **67**
- Speed limit warning, refer to Speed limit **67**
- "Speed volume", refer to Tone control **134**
- Speed-dependent volume **133**
- Speedometer **12**
- Split rear seat backrest, refer to Expanding the cargo bay **98**
- Splitdoor **31**
 - opening from outside **31**
- unlocking with remote control **29**
- Sport button **73**
- Stability control, refer to Driving stability control systems **71**
- "Start guidance" **115, 117**
- Start menu **17**
- Start/stop button **46**
 - starting the engine **47**
 - switching off the engine **47**
- Starting assistance, refer to Jump-starting **186**
- Starting, refer to Starting the engine **47**
- Starting the engine
 - start/stop button **46**

- Start-off assistance, refer to
 - DSC 71
 - Hill Assist 73
- "State / Province" in destination input 109
- Station, refer to Radio 135
- "Status" 61
- Status of this Owner's Manual at time of printing 4
- Steering wheel 41
 - adjustment 41
 - buttons on steering wheel 11
 - lock 46
 - shift paddles 49
- Steptronic, refer to Automatic transmission with Steptronic 48
- "Stopwatch" 68
- Stopwatch 68
- Storage area
 - cargo bay 98
- Storage compartment, front passenger side 91
- Storage compartments 90
- Storage space
 - storage compartments 90
- "Store in address book" in Navigation 116
- "Store" on the radio 137, 141
- Storing current position 116
- Storing radio stations 137
- Storing the vehicle 175
- Storing tires 166
- Stowage, refer to Storage compartments 90
- "Street" in destination input 110
- Summer tires, refer to Wheels and tires 158
- Switches, refer to Cockpit 10
- Switching off
 - engine 47
- Switching off the engine
 - start/stop button 46
- Switching on
 - audio 132
 - CD changer 132
 - CD player 132
 - radio 132
- Switching on the hour signal 64
- Switching the cooling function on and off 87
- Symbols 4
 - Control Display 20
 - navigation system 126
 - traffic info in the navigation system 126
- T**
- Tachometer 55
- Tail lamp, refer to Tail lamps 179
 - replacing bulb 179
- Tail lamps 179
- Tank volume, refer to Capacities 194
- Technical data 192
- Technical modifications 5
- Telephone
 - installation location, refer to Center armrest 90
 - refer to separate Owner's Manual
- Telephone call, refer to the Owner's Manual for the telephone
- Temperature display
 - ice warning 55
 - outside temperature 55
 - setting the units 60
- Temperature of coolant, refer to Coolant temperature 56
- Temperature setting
 - automatic climate control 86
- Tempomat, refer to Cruise control 53
- Tensioning straps, refer to Securing cargo 100
- "Text language" 69
- The individual vehicle 4
- Third brake lamp, refer to Center brake lamp 180
- Three-point safety belt 40
- Tightening the lug bolts
 - keys 183
 - torque 184, 185
- Tightening torque, refer to Tightening lug bolts 184
- "Time format" 64
- Tire change set
 - space-saver spare tire 183
- Tire failure
 - Flat Tire Monitor 74
 - indicator/warning lamp 74
 - MINI Mobility System 180
 - run-flat tires 75
 - space-saver spare tire 183
 - Tire Pressure Monitor 75
- Tire inflation pressure 158
 - loss 74, 76
 - space-saver spare tire 158
- Tire Pressure Monitor TPM 75
 - limitations of system 75
 - resetting system 76
 - warning lamp 77
- Tire pressure monitoring, refer to Flat Tire Monitor 73
- Tire Quality Grading 163
- Tires
 - age 164
 - breaking in 96
 - changing, refer to Changing wheels 183
 - condition 164
 - damage 164
 - inflation pressure 158
 - inflation pressure loss 77
 - minimum tread depth 164
 - new tires 165
 - pressure monitoring, refer to Flat Tire Monitor 73
 - pressure monitoring, refer to Tire Pressure Monitor TPM 75
 - puncture 74
 - size 163
 - wear indicators, refer to Minimum tread depth 164
 - winter tires 166
 - with emergency operation properties 165
- Tires, FTM 74
- Tires with emergency operation properties, refer to Run-flat tires 165

Tires with safety features, refer to Run-flat tires [165](#)
 TMC station, refer to Traffic information [124](#)
 Tone during audio playback
 – adjusting [133](#)
 – middle setting [134](#)
 Tools, refer to Onboard vehicle tool kit [176](#)
 Torque [192](#)
 – lug bolts [184](#)
 Tow bar [188](#)
 Tow fitting [187](#)
 – screw thread [187](#)
 Tow fittings for tow-starting and towing away [187](#)
 Tow rope [188](#)
 Towing [187](#)
 – car with automatic transmission [188](#)
 – methods [188](#)
 "Town / City" in destination input [109](#)
 Tow-starting [187](#)
 TPM, refer to Tire Pressure Monitor [75](#)
 Track width, refer to Dimension [193](#)
 Traction control, refer to
 – Dynamic Stability Control DSC [71](#)
 Traffic congestion
 – displaying traffic information [124](#)
 Traffic information for navigation
 – calling up [124](#), [125](#)
 – display on route map [125](#)
 – during destination guidance [127](#)
 Traffic information report list [125](#)
 Transmission
 – automatic transmission with Steptronic [48](#)
 – manual transmission [48](#)
 – overriding selector lever lock for automatic transmission with Steptronic [50](#)

Transport securing devices, refer to Securing cargo [100](#)
 Transporting children safely [43](#)
 Tread depth, refer to Minimum tire tread [164](#)
 Treble, refer to Tone control [133](#)
 Treble, refer to Treble and bass [133](#)
 Treble, tone control [133](#)
 "Trip computer" [58](#)
 Trip computer [58](#)
 Trip odometer [55](#)
 Trip-distance counter, refer to Trip odometer [55](#)
 "Triple turn signal" [51](#)
 Triple turn signal activation [50](#)
 Turn signal indicator [50](#)
 – front, replacing bulb [178](#)
 – indicator lamp [12](#), [13](#)
 – rear, replacing bulb [179](#)
 – side, replacing bulb [179](#)
 Turning circle, refer to Dimensions [193](#)
 Tying down loads, refer to Cargo loading [100](#)

U

Uniform Tire Quality Grading UTQR [163](#)
 "Units" [60](#)
 Units
 – average fuel consumption [60](#)
 – temperature [60](#)
 Universal garage door opener, refer to Integrated universal remote control [88](#)
 Universal remote control [88](#)
 Unlatching, refer to Unlocking [33](#)
 "Unlock button" [28](#)
 Unlocking
 – from inside [30](#)
 – from outside [27](#)
 – liftgate [33](#)
 – without remote control, refer to Comfort Access [33](#)
 Upholstery, care [173](#)

USB audio interface [150](#)

V

Vehicle
 – battery [185](#)
 – breaking in [96](#)
 – cargo loading [98](#)
 – dimensions [193](#)
 – Identification Number, refer to Engine compartment [168](#)
 – parking [47](#)
 – storage [175](#)
 – weight [194](#)
 Vehicle jack [183](#)
 – jacking points [184](#)
 Vehicle position, refer to Displaying current position [127](#)
 Ventilation
 – air conditioner [87](#)
 Vents, refer to Ventilation [87](#)
 Voice commands
 – overview [21](#)
 – short commands [195](#)
 Voice instructions from navigation system [123](#)
 – switching on/off [123](#)
 – volume [123](#)
 Volume [132](#)
 – audio sources [132](#)
 – speed-dependent control [133](#)
 – voice instructions [123](#)
 Volume distribution
 – front/rear [133](#)
 – left/right [133](#)
 Volume of cargo area [194](#)

W

Warning and indicator lamps [13](#)
 Warning messages, refer to Check Control [65](#)
 Warning triangle [186](#)
 Washer fluid [52](#)
 – capacity of reservoir [53](#)
 Washer fluid reservoir [52](#)

Waste tray, refer to Ashtray [91](#)

Water on roads, refer to
 Driving through water [97](#)

Waterfall lighting, refer to
 Ambient lighting [84](#)

Waveband of radio [135](#)

Wear indicators in tires, refer to
 Minimum tread depth [164](#)

Weights [194](#)

Welcome lamps [81](#)

Wheel stud wrench
 – space-saver spare tire [183](#)

Wheelbase, refer to
 Dimensions [193](#)

Wheels and tires [158](#)

Wheels, new [165](#)

Width, refer to
 Dimensions [193](#)

Window washer, refer to
 Washer fluid [52](#)

Window washer reservoir,
 refer to Washer fluid
 – volume, refer to
 Capacities [194](#)

Window washer system [51](#)
 – washer fluid [52](#)
 – washer jets [52](#)

Windows [35](#)
 – closing [35](#)
 – convenient operation [28](#)
 – opening [35](#)
 – pinch protection system [36](#)

Windows, indicator on Control
 Display [16](#)

Windshield
 – cleaning [52](#)
 – defrosting and removing
 condensation [87](#)

Windshield wiper blades,
 changing [176](#)

Windshield wipers, refer to
 Wiper system [51](#)

Winter tires [166](#)
 – setting speed limit [67](#)
 – storage [166](#)

Wiper blade replacement [176](#)

Wiper system [51](#)

"With highways" in
 Navigation [118](#)

Word-matching principle for
 navigation [119](#)

Work in the engine
 compartment [167](#)

Wrench/screwdriver, refer to
 Onboard vehicle tool kit [176](#)

X

Xenon lamps
 – replacing bulb [177](#)



DRIVE ME.

01 41 2 604 465 Ue Navi